



National Aeronautics and
Space Administration

Educational Product

Teachers Grades 5-12

Exploring Meteorite Mysteries

A Teacher's Guide with Activities for Earth and Space Sciences

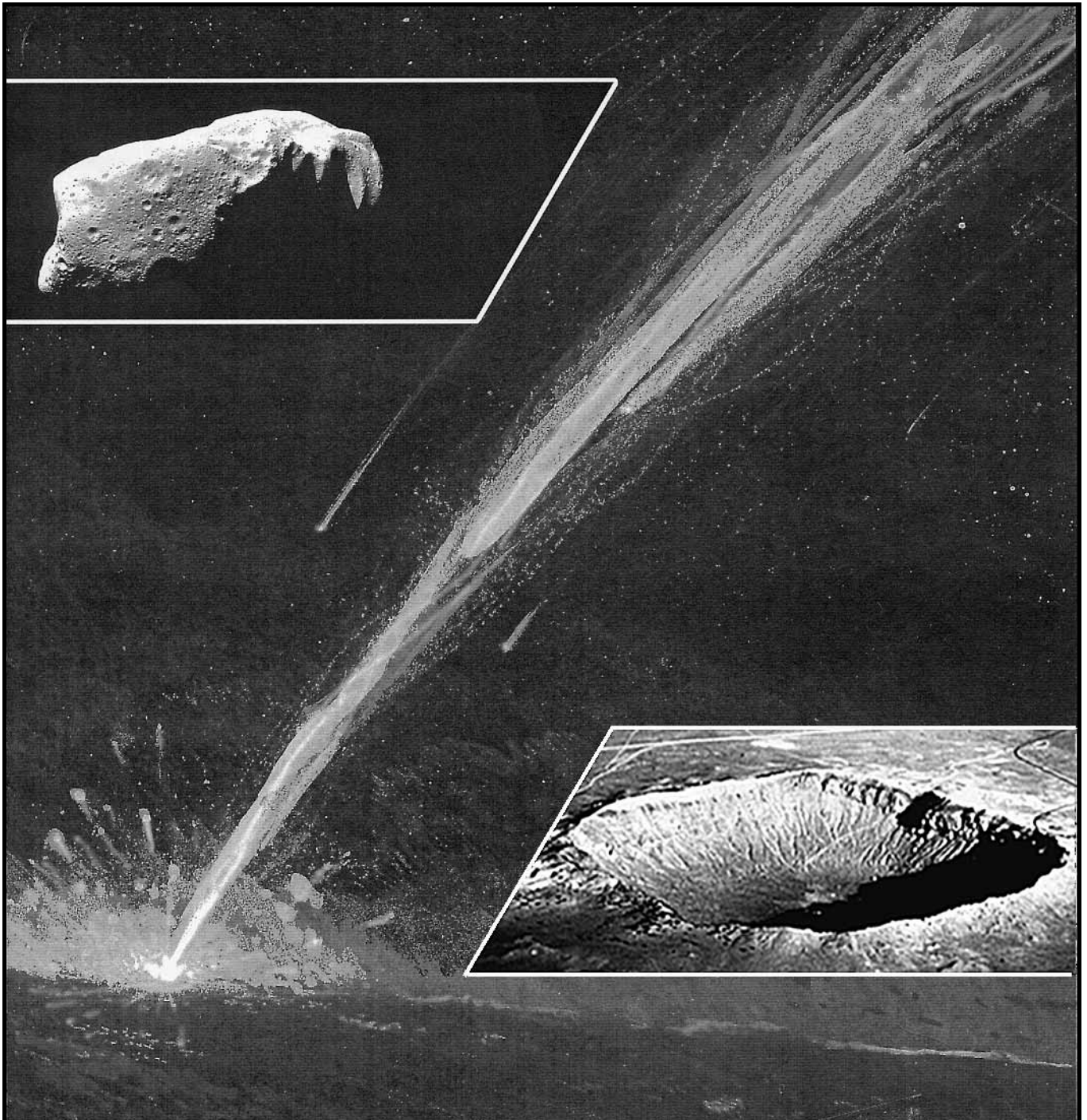



National Aeronautics and
Space Administration

EG-1997-08-104-HQ

Exploring Meteorite Mysteries

A Teacher's Guide with Activities for Earth and Space Sciences

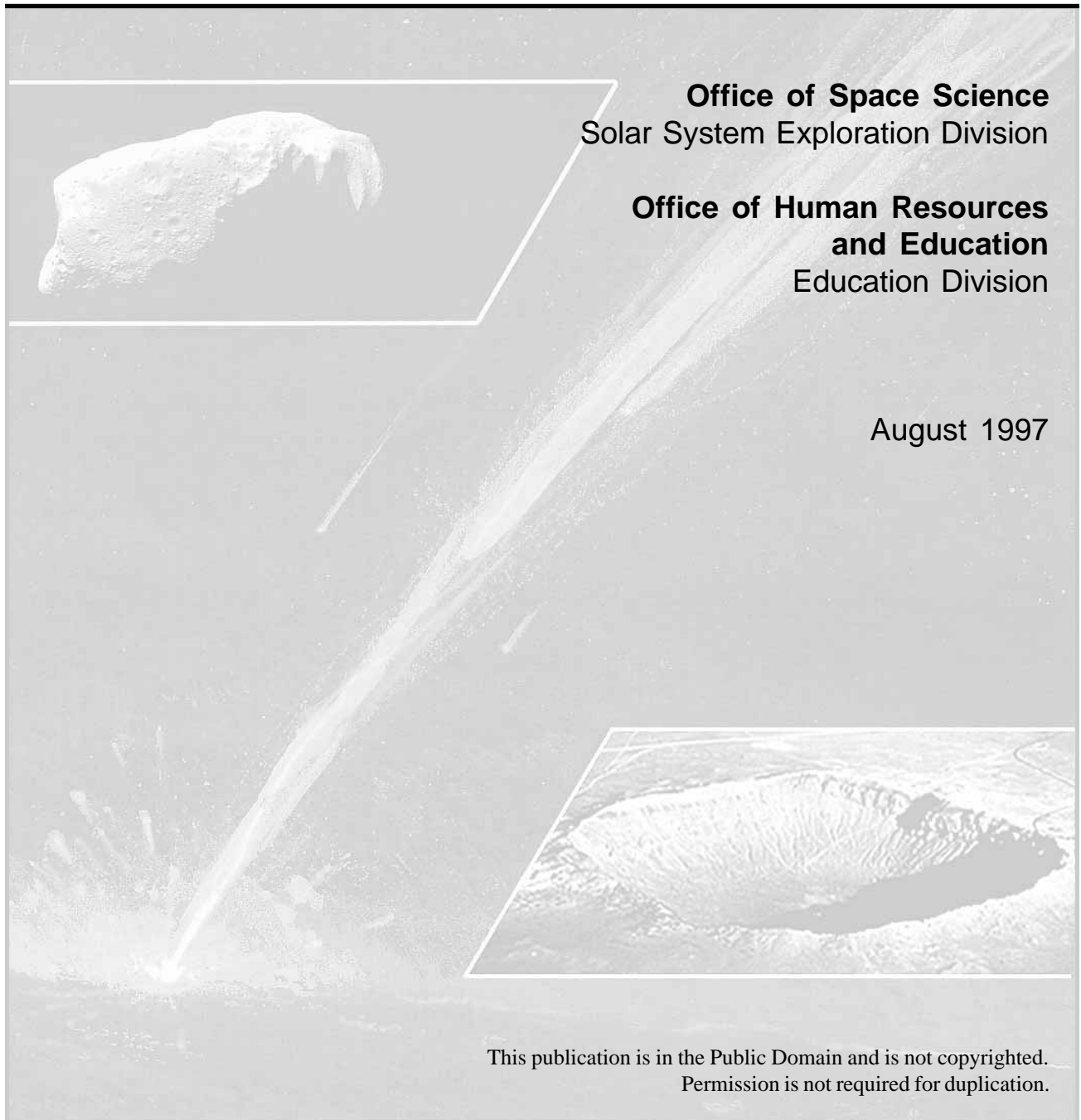

Office of Space Science
Solar System Exploration Division

**Office of Human Resources
and Education**
Education Division

August 1997

This publication is in the Public Domain and is not copyrighted.
Permission is not required for duplication.

Acknowledgements

This teacher's guide was developed in a partnership between scientists in the Planetary Materials Office, at NASA's Johnson Space Center in Houston, Texas, and teachers from local school districts.

NASA and Contractor Staff

Marilyn Lindstrom

Project Coordinator and Meteorite Curator
NASA Johnson Space Center
Houston, Texas

Jaclyn Allen

Scientist and Science Education Specialist
Lockheed Martin Engineering & Sciences Co.
Houston, Texas

Allan Treiman* and Carl Allen

Planetary Scientists
Lockheed Martin Engineering & Sciences Co.
Houston, Texas

Anita Dodson

Graphic Designer
Lockheed Martin Engineering & Sciences Co.
Houston, Texas



National Aeronautics and
Space Administration
Lyndon B. Johnson Space Center
**Earth Science and Solar System
Exploration Division**

Teachers

JoAnne Burch

Pearland ISD,
Elementary
Pearland, Texas

Karen Crowell

Pasadena ISD,
Elementary
Pasadena, Texas

Roy Luksch

Alvin ISD,
High School
Alvin, Texas

Karen Stocco

Pasadena ISD,
High School
Pasadena, Texas

Bobbie Swaby

Pasadena ISD,
Middle School
Pasadena, Texas

Kay Tobola

Alvin ISD,
Middle School
Alvin, Texas

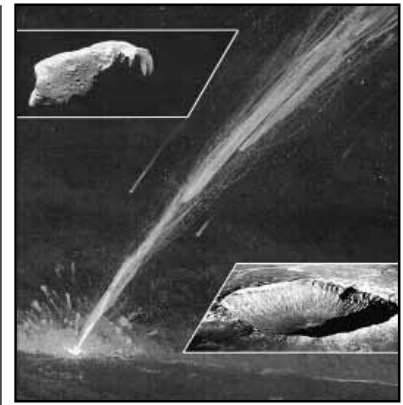

On the Cover—

Several aspects of a meteorite fall are depicted on the cover. The background is a painting created by an eyewitness of the Sikhote-Alin fireball. At the top is the asteroid Ida, a possible source of meteorites. At the bottom is Meteor Crater in Arizona—the first identified meteorite impact crater.

We would also like to thank the following for reviews and meteorite samples:

NASA - Don Bogard, Mark Cintala, Everett Gibson, Kathleen McBride, Dave Mittlefehldt, Larry Nyquist, Cecilia Satterwhite, Carol Schwarz, Roberta Score,** Faith Vilas, and Mike Zolensky.

NASA/OSU - Richard Adams, Jim Fitzgerald, Larry Gilbert, Les Gold, Tibisay Marin, Debbie Shearer, Greg Vogt, and Ralph Winrich.

Teachers - Gregg Baumgartner, Stephanie McNeel, and Susan Ross (Alvin ISD); Jean Groover and John Ristvey (Clear Creek ISD); Cathy Corley and Jeanie Thuneman (Friendswood ISD) and John Beasley (Stafford MSD).

Organizations - U.S. Antarctic Program (NSF), NNMH Smithsonian Institution, NASA, and the Field Museum of Natural History.

*Now at the Lunar & Planetary Institute, Houston, Texas.

**Now at Antarctic Support Services, Denver, Colorado.

Contents

About <i>Exploring Meteorite Mysteries</i>	iii
About the Meteorite Disk	iv
About the Slide Set	iv
Science Process Skills	v
Science and Mathematics Standards	vii
Lesson Topic Planner	ix
Lesson Sequence Suggestions	x
Teacher's Guide	
Meteorites, Clues to Solar System History	1
Meteorite ABC's Fact Sheet	29
Solar System ABC's Fact Sheet	31
Mysterious Meteorites	
Lesson 1: Noblesville Fall	1.1
Where Do They Come From?	
Lesson 2: Follow the Falling Meteorite	2.1
Lesson 3: Searching for Meteorites	3.1
Lesson 4: The Meteorite-Asteroid Connection	4.1
Lesson 5: Looking at Asteroids	5.1
Lesson 6: Impact Craters — Holes In the Ground!	6.1
Lesson 7: Crater Hunters	7.1
What Are They?	
Lesson 8: Edible Rocks	8.1
Lesson 9: Meteorite Sleuths!	9.1
How Did They Form?	
Lesson 10: Building Blocks of Planets	10.1
Lesson 11: Changes Inside Planets	11.1
Lesson 12: Building Blocks of Life	12.1
Lesson 13: Solving a Mystery	13.1
What Effect Do They Have?	
Lesson 14: Direct Hit at the K-T Boundary	14.1
Lesson 15: Historical Meteorite Falls	15.1
Lesson 16: Near Miss	16.1
How Can I Use Them?	
Lesson 17: Asteroid Resources	17.1
Is There a Career for Me?	
Lesson 18: Antarctic Meteorite Teams	18.1
What Can We Believe?	
Lesson 19: <i>The Daily Shooting Star</i>	19.1
Glossary	A.1
Education Resources	B.1

About *Exploring Meteorite Mysteries*

Teachers and scientists designed this book to engage students in inquiry science and to extend science with interdisciplinary connections. The study of meteorites provides a unifying theme that links almost every aspect of Earth and planetary science with mathematics, physics, chemistry and even biology. The effects of meteorite impacts have serious implications for social science. The activities in this book are designed for upper elementary to high school levels. Many of the lessons begin with a simple activity and build to more complex ones. The Curriculum Content Matrix, Lesson Topic Planner and Lesson Sequence Suggestions may assist teachers in integrating the meteorite activities with their existing Earth science curricula and standards requirements.

The Teacher's Guide, *Meteorites, Clues to Solar System History*, gives a broad introduction to many aspects of meteorite science. It tells the story of solar system history from the formation of the planets to catastrophic impacts on Earth. It helps the students learn how scientists use studies of these rocks from space to decipher that history. The Meteorite ABC's and Solar System ABC's Fact Sheets contain important information about meteorites and bodies in the solar system in convenient table format.

The Activities are divided into units based on key questions students may ask about meteorites. For example, the unit entitled "Where do they come from?" contains six lessons with many activities that explore that question. The activities range from introductory impact experiments to rather complex orbit constructions that use beginning geometry. Some lessons are designed to use the Meteorite Sample Disk, although most lessons do not require the disk. All the lessons could be taught in the science classroom, but many lessons could be used in other areas. The lessons include both teacher and student pages, both of which may be copied as needed. Measurements are given in metric units with some English units in parentheses for common household items.

The book concludes with a Glossary and an Education Resources section. Key words that appear in bold in the Teachers' Guide or as vocabulary in the Activities are defined in the glossary. The Education Resources section lists specific books and supporting materials for meteorites. It also provides a guide to accessing the broad range of NASA resources for educators.

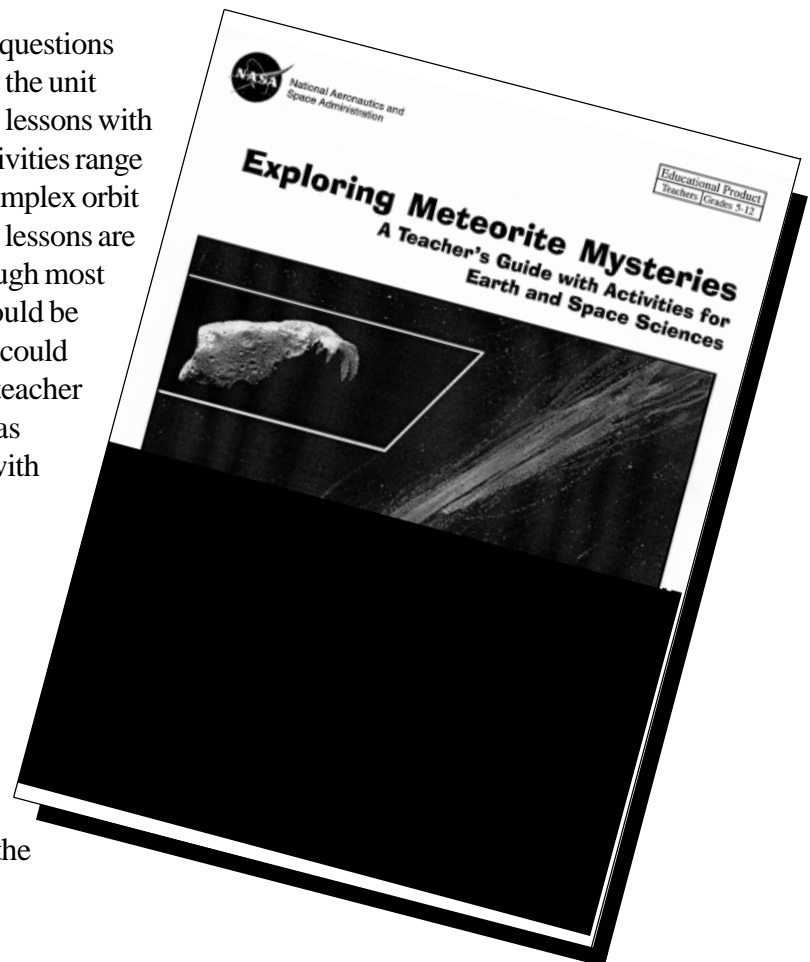

About the Meteorite Sample Disk

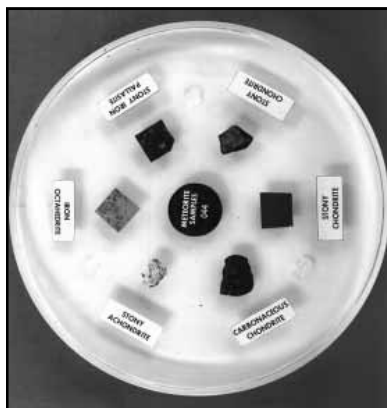

The Meteorite Sample Disk contains six labeled meteorites embedded in a 15 cm plastic disk. These pieces of asteroids represent the products of basic planetary processes: accretion, differentiation, volcanism and impact. Educators may borrow the Meteorite Sample Disk containing these rocks from space to help students learn about the early history of the solar system. The Meteorite Sample Disk package contains the disk, a copy of this activity guide, and the *Exploring Meteorite Mysteries* slide set described below.

To borrow the Meteorite Sample Disk educators must first attend a short certification briefing on security requirements and handling procedures.

This is the same certification as for borrowing the Lunar Sample Disk. These briefings are given by NASA staff at locations around the country. Following certification educators may request the loan of the disks for periods of one to two weeks. Written requests should be sent to the NASA Educator Resource Center in your geographic area at least one month before the requested loan date. For more information on scheduling certification and request procedures, educators should contact their Educator Resource Center at the locations given on page B.2 at the end of this book.

About the Slide Set

A set of forty-eight 35 mm slides has been prepared to supplement the activities in this *Exploring Meteorite Mysteries* book. The slides and narrative descriptions are divided into four parts. The first 25 slides present a general introduction to meteorites and what they tell us about the history of the solar system. It begins with observations of meteorite falls, depicts meteorites and their formation processes, and concludes with their impact on life and future exploration of the solar system. The remaining three parts are more detailed sections for use with various lessons in the activity guide. These sections reuse some of the slides from the introduction. One section on impact craters illustrates craters on Earth, the Moon and other planets. The next section on classification and formation depicts various meteorite types and the processes of accretion, differentiation, volcanism, and impact. The final section shows collection, curation, and research on Antarctic meteorites.

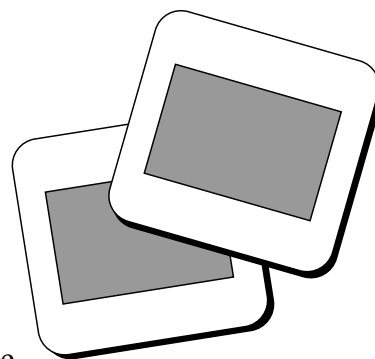

The slide set is distributed to educators with the Meteorite Sample Disk. Anyone desiring a permanent copy of the slide set may order it at cost from NASA Central Operation of Resources for Educators (CORE). The address and various contacts for CORE are listed on page B.2 at the back of this book.

Science Process Skills

for Exploring Meteorite Mysteries

This chart is designed to assist teachers in integrating the activities contained in the guide with existing curricula.

Unit	Lesson	Observing	Classifying	Communicating	Measuring	Inferring	Predicting	Experimental Design	Gathering and Organizing Data	Controlling Variables	Developing a Hypothesis	Extending Senses	Researching	Team Work	Mathematics	Interdisciplinary	Introductory Activity	Advanced Activity
<i>Mysterious Meteorites</i>	Lesson 1 Noblesville Fall	✓	✓	✓		✓	✓									✓	✓	
<i>"Where Do They Come From?"</i>	Lesson 2 Follow the Falling Meteorite	✓		✓	✓	✓	✓	✓	✓			✓		✓	✓	✓	✓	✓
	Lesson 3 Searching for Meteorites	✓		✓	✓	✓	✓	✓	✓	✓	✓			✓	✓	✓	✓	
	Lesson 4 The Meteorite-Asteroid Connection	✓			✓		✓							✓	✓		✓	✓
	Lesson 5 Looking at Asteroids	✓			✓	✓		✓	✓			✓			✓		✓	✓
	Lesson 6 Impact Craters—Holes in the Ground!	✓		✓	✓	✓	✓	✓	✓	✓	✓			✓	✓		✓	✓
	Lesson 7 Crater Hunters	✓		✓		✓	✓	✓	✓		✓		✓	✓	✓	✓	✓	✓
<i>"What Are They?"</i>	Lesson 8 Edible Rocks	✓		✓								✓		✓	✓	✓	✓	

Unit	Lesson	Observing	Classifying	Communicating	Measuring	Inferring	Predicting	Experimental Design	Gathering and Organizing Data	Controlling Variables	Developing a Hypothesis	Extending Senses	Researching	Team Work	Mathematics	Interdisciplinary	Introductory Activity	Advanced Activity
<i>“What Are They?”</i>	Lesson 9 Meteorite Sleuths!	✓	✓	✓	✓	✓	✓		✓			✓			✓	✓		
<i>“How Did They Form?”</i>	Lesson 10 Building Blocks of Planets	✓	✓	✓		✓	✓							✓		✓	✓	
	Lesson 11 Changes Inside Planets	✓	✓	✓	✓	✓	✓		✓	✓		✓		✓	✓		✓	
	Lesson 12 Building Blocks of Life	✓		✓	✓	✓	✓	✓		✓				✓	✓	✓	✓	✓
	Lesson 13 Solving a Mystery	✓	✓	✓	✓	✓	✓		✓			✓			✓			✓
<i>“What Effect Do They Have?”</i>	Lesson 14 Direct Hit at the K-T Boundary	✓		✓	✓	✓	✓	✓	✓	✓		✓		✓	✓	✓	✓	✓
	Lesson 15 Historical Meteorite Falls			✓		✓							✓		✓	✓	✓	
	Lesson 16 Near Miss			✓		✓							✓	✓		✓	✓	✓
<i>“How Can I Use Them?”</i>	Lesson 17 Asteroid Resources	✓		✓	✓			✓	✓			✓	✓	✓	✓	✓	✓	✓
<i>“Is There a Career for Me?”</i>	Lesson 18 Antarctic Meteorite Teams	✓		✓		✓							✓	✓	✓	✓		✓
<i>“What Can We Believe?”</i>	Lesson 19 The Daily Shooting Star			✓		✓							✓		✓	✓	✓	✓

Science and Mathematics Standards for Exploring Meteorite Mysteries

	Science as Inquiry	Structure and Energy of the Earth System	Origin and History of the Earth	Earth in the Solar System	Geochemical Cycles	Physical Science	Populations and Ecosystems	Understanding about Science and Technology	Science in Personal and Social Perspectives	History and Nature of Science		Problem Solving	Measurement	Computation and Estimation	Communication	Geometry and Advanced Mathematics	Statistics and Probability	Number and Number Relationships	Patterns and Functions
Lesson 1 Noblesville Fall	✓		✓	✓				✓	✓	✓									
Lesson 2 Follow the Falling Meteorite	✓	✓		✓		✓		✓		✓		✓	✓	✓	✓	✓	✓		✓
Lesson 3 Searching for Meteorites	✓	✓	✓	✓				✓		✓		✓		✓	✓		✓	✓	✓
Lesson 4 The Meteorite- Asteroid Connection	✓	✓	✓	✓		✓		✓		✓		✓	✓	✓	✓	✓	✓	✓	✓
Lesson 5 Looking at Asteroids	✓		✓			✓		✓		✓		✓	✓		✓		✓	✓	✓
Lesson 6 Impact Craters— Holes in the Ground!	✓	✓	✓			✓		✓				✓	✓	✓	✓		✓		✓
Lesson 7 Crater Hunters	✓	✓	✓		✓			✓	✓	✓		✓		✓	✓		✓		✓
Lesson 8 Edible Rocks	✓	✓							✓	✓		✓		✓	✓				✓

	Science as Inquiry	Structure and Energy of the Earth System	Origin and History of the Earth	Earth in the Solar System	Geochemical Cycles	Physical Science	Populations and Ecosystems	Understanding about Science and Technology	Science in Personal and Social Perspectives	History and Nature of Science		Problem Solving	Measurement	Computation and Estimation	Communication	Geometry and Advanced Mathematics	Statistics and Probability	Number and Number Relationships	Patterns and Functions
Lesson 9 Meteorite Sleuths	✓		✓		✓	✓		✓				✓	✓	✓	✓		✓		✓
Lesson 10 Building Blocks of Planets	✓	✓	✓	✓	✓	✓		✓							✓				
Lesson 11 Changes Inside Planets	✓	✓	✓	✓	✓	✓		✓				✓	✓						
Lesson 12 Building Blocks of Life	✓	✓	✓	✓	✓	✓		✓	✓	✓		✓	✓		✓				
Lesson 13 Solving a Mystery	✓					✓		✓	✓			✓	✓	✓	✓				✓
Lesson 14 Direct Hit at the K-T Boundary	✓		✓	✓	✓		✓	✓	✓	✓		✓	✓	✓	✓		✓	✓	✓
Lesson 15 Historical Meteorite Falls	✓		✓	✓			✓		✓	✓						✓			
Lesson 16 Near Miss			✓	✓			✓	✓	✓	✓					✓				
Lesson 17 Asteroid Resources	✓	✓						✓	✓	✓		✓	✓	✓	✓		✓	✓	✓
Lesson 18 Antarctic Meteorite Teams	✓						✓	✓	✓	✓					✓				✓
Lesson 19 The Daily Shooting Star	✓	✓	✓	✓			✓	✓	✓	✓					✓			✓	

Lesson Topic Planner

for Exploring Meteorite Mysteries

This matrix indicates some of the lessons in Exploring Meteorite Mysteries that could be used to enhance selected science topic themes frequently used in Earth/Space Science curricula.

Metric and Scientific Method (*students use metric measurements in activities*)

- Lesson 2** Follow the Falling Meteorite
- Lesson 4** The Meteorite-Asteroid Connection
- Lesson 6** Impact Craters — Holes in the Ground!
- Lesson 9** Meteorite Sleuths

Water (*fresh and oceans*)

- Lesson 12** Building Blocks of Life
- Lesson 14** Direct Hit at the K-T Boundary
- Lesson 16** Near Miss
- Lesson 17** Asteroid Resources

Atmosphere/Climate/Weather

- Lesson 14** Direct Hit at the K-T Boundary
- Lesson 16** Near Miss

Rocks/Minerals/Geologic Time

- Lesson 1** Noblesville Fall
- Lesson 6** Impact Craters — Holes in the Ground!
- Lesson 7** Crater Hunters
- Lesson 8** Edible Rocks
- Lesson 9** Meteorite Sleuths
- Lesson 10** Building Block of Planets
- Lesson 11** Changes Inside Planets
- Lesson 12** Building Blocks of Life
- Lesson 13** Solving a Mystery
- Lesson 14** Direct Hit at the K-T Boundary

Planet Dynamics

Earthquakes

- Lesson 14** Direct Hit at the K-T Boundary
- Lesson 16** Near Miss
- Lesson 6** Impact Craters — Holes in the Ground!

Plate Tectonics and Volcanism

- Lesson 7** Crater Hunters
- Lesson 10** Building Blocks of Planets
- Lesson 11** Changes Inside Planets
- Lesson 14** Direct Hit at the K-T Boundary

Weathering and Erosion

- Lesson 6** Impact Craters — Holes in the Ground!
- Lesson 7** Crater Hunters

Natural Resources/National Parks

- Lesson 3** Searching for Meteorites
- Lesson 10** Building Blocks of Planets
- Lesson 11** Changes Inside Planets
- Lesson 12** Building Blocks of Planets
- Lesson 17** Asteroid Resources

Historical Connections/ People/Careers

- Lesson 1** Noblesville Fall
- Lesson 7** Crater Hunters
- Lesson 14** Direct Hit at the K-T Boundary
- Lesson 15** Historical Meteorite Falls
- Lesson 16** Near Miss
- Lesson 18** Antarctic Meteorite Teams
- Lesson 19** The Daily Shooting Star

Space (*Stars and Solar System*)

- Lesson 1** Noblesville Fall
- Lesson 2** Follow the Falling Meteorite
- Lesson 3** Searching for Meteorites
- Lesson 4** The Meteorite-Asteroid Connection
- Lesson 5** Looking at Asteroids
- Lesson 10** Building Blocks of Planets
- Lesson 11** Changes Inside Planets
- Lesson 17** Asteroid Resources

Lesson Sequence Suggestions

for Exploring Meteorite Mysteries

Lesson Groups are suggested for one or a combination of several of the following criteria: time available in the classroom, theme or topic of existing curricula, Meteorite Sample Disk availability, and interdisciplinary connections. More than one lesson could be accomplished in a 90-minute class. Some lessons may be inserted directly into existing Earth/Space Science curricula as enrichment activities without a more extensive meteorite focus.

Activities Without Meteorite Sample Disk

Stand alone activities for one or two class periods without Meteorite Sample Disk.

- Lesson 1** Noblesville Fall
- Lesson 2** Follow the Falling Meteorite
- Lesson 4** The Meteorite-Asteroid Connection:
Orbits in the inner Solar System
- Lesson 6** Impact Craters —Holes in the Ground!
- Lesson 7** Crater Hunters
- Lesson 8** Edible Rocks
- Lesson 10** Building Blocks of Planets (non-Meteorite Sample Disk activities only)
- Lesson 11** Changes Inside Planets (non-Meteorite Sample Disk activities only)
- Lesson 12** Building Blocks of Life
- Lesson 14** Direct Hit at the K-T Boundary
- Lesson 15** Historical Meteorite Falls
- Lesson 16** Near Miss
- Lesson 18** Antarctic Meteorite Teams

One week without Meteorite Sample Disk. (*Emphasizing basic meteorite background and hands-on activities on impact cratering.*)

- Lesson 1** Noblesville Fall
- Lesson 2** Follow the Falling Meteorite
- Lesson 3** Searching for Meteorites
- Lesson 6** Impact Craters —Holes in the Ground!

One or two weeks without Meteorite Sample Disk. (*Emphasizing basic meteorite background and hands-on activities about the origin and physical characteristics of meteorites.*)

- Lesson 1** Noblesville Fall
- Lesson 8** Edible Rocks
- Lesson 10** Building Blocks of Planets
- Lesson 11** Changes Inside Planets
- Lesson 12** Building Blocks of Life
- Lesson 13** Solving a Mystery

Activities With Meteorite Sample Disk

One or two class periods with Meteorite Sample Disk.
(*other lessons do not need the Disk*)

Sequence of :

- Lesson 1** Noblesville Fall
- Lesson 10** Building Blocks of Planets
- Lesson 11** Changes inside Planets

or

- Lesson 8** Edible Rocks
- Lesson 10** Building Blocks of Planets
- Lesson 11** Changes Inside Planets

or

- Lesson 8** Edible Rocks
- Lesson 9** Meteorite Sleuths!

One week with a Meteorite Sample Disk.

Sequence of :

- Lesson 1** Noblesville Fall
- Lesson 8** Edible Rocks
- Lesson 10** Building Blocks of Planets
- Lesson 11** Changes Inside Planets

or

- Lesson 1** Noblesville Fall
- Lesson 8** Edible Rocks
- Lesson 9** Meteorite Sleuths!

Meteorites, Clues to Solar System History

A family on a camping trip watches a bright light streak across the sky and disappear.

An explorer comes upon a circular crater with rocks scattered around its rim.

Two boys watch a rock fall from the sky and land near them.

A farmer picks up an unusually heavy rock while plowing his field.

A scientist discovers the rare element iridium in a soil layer that marks the end of the age of dinosaurs.

All of these people have discovered possible evidence of rocks from space that passed through the atmosphere and landed on Earth. Sometimes there is little or no evidence of the rock itself; it burned up in the atmosphere or broke up on impact. Other times the rock is all there is, with little evidence of its fiery entry or crash landing. These events all involve the mysteries of meteorites: what they are, where they come from, how they got here, how they affect people, and what they tell us about the solar system. These are some of the questions that are investigated in *Exploring Meteorite Mysteries*.

Meteorites are rocks from space that have survived their passage through the atmosphere to land on Earth's surface. Some meteorites are seen or heard to fall and are picked up soon afterward, while most are found much later. Some meteorites are large enough to produce impact craters or showers of fragments, but others are small enough to hold in one hand, and still others are so small that you need to use a microscope to see them. Some meteorites are like igneous rocks on Earth, others are pieces of metal, and others are different from all known Earth rocks. Yet, despite their variety in size, appearance, and manner of discovery, all meteorites are pieces of other bodies in space that give us clues to the origin and history of the solar system.

Noblesville meteorite. The 0.5 kg (fist-sized) meteorite found by the boys. Inside Noblesville is a gray stony meteorite, but outside it is covered by a dark brown glassy crust.



Brodie Spaulding (age 13) and Brian Kinzie (age 9). The boys are standing on the lawn where they observed the Noblesville, Indiana meteorite fall on August 31, 1991. (Photo by M. Lipschutz)



Meteorite Fall and Recovery

Meteors, Falls and Finds

Meteors, bright streaks of light moving rapidly across the sky, are fairly common. On a clear night outside the city you could see an average of three or four an hour. Sometimes many more meteors are visible. These times are called **meteor showers** and many showers return year after year on the same dates. These showers are associated with comet dust left by long-passed comets. However, very few meteors, and none of the yearly meteor showers, yield meteorites on Earth's surface. Most of the dust and ice particles burn up completely as they pass through the atmosphere.

Only a few people each year actually see a meteorite fall. Meteorites that are recovered soon after they land on Earth are called **falls**. About 900 meteorite falls have been recovered around the world, mostly in the last 200 years. The fall of a relatively small meteorite is exciting, but not dramatic unless it injures a person or damages property. When young Brodie Spaulding and Brian Kenzie observed the fall of the small Noblesville meteorite in August 1991 (see Lesson 1), they saw no bright light and heard only a whistling sound. The meteorite was slightly warm to touch and made a small hole in the ground where it landed.

Falls of large meteorites are rare, occurring only once every few decades, but are dramatic, beginning with the bright streak of light and thunderous noise of a **fireball**. The falls of the Allende stony meteorite in rural Mexico and the Sikhote-Alin iron meteorite in Siberia, Russia, were two recent large falls (see Lesson 15). Both meteorite falls began with bright light and explosions that were seen, heard and felt for great distances. The cover of this booklet shows the Sikhote-Alin fireball as depicted in an eyewitness painting. The fall sites for the two meteorites were soon found. Allende was scattered over a 150 square kilometer area

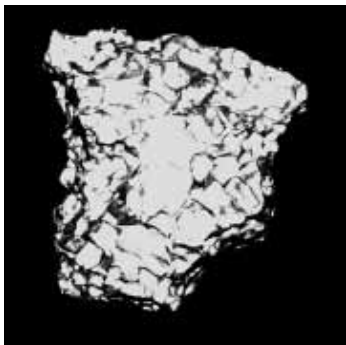

Sikhote-Alin meteorite. This is a fragment from the Sikhote-Alin shower that fell in Russia in February, 1947. It is an iron meteorite that is covered by black fusion crust and indentations like thumbprints from melting during flight through the atmosphere. The Sikhote-Alin irons weighed a total of 23,000 kg, with the largest piece weighing 300 kg.



Allende meteorite. This is a fragment from the Allende shower that fell in Mexico in February 1969. It is a dark gray stony meteorite with black glassy fusion crust. The Allende stones weighed a total of 2,000 kg, with the largest piece weighing 100 kg.



***Meteor Crater in Arizona.** This 1.2 km wide, 150 m deep, crater was made by a 30 m iron meteorite weighing about 1,000,000,000 kg. Thousands of fragments totaling 30,000 kg of the Canyon Diablo iron meteorite have been found, but most of the meteorite was vaporized by the heat of the impact.*

around the town of Pueblito del Allende. The Sikhote-Alin site was located from the air by its devastation of a forested area. On the ground scientists found over 100 craters of varying sizes. Both meteorites fell as thousands of fragments covering wide areas. The breakup and fall of a large meteorite like Allende or Sikhote-Alin before impact is called a **meteorite shower**. (See Lessons 2 and 3)

The impact of a huge meteorite has never been observed and recorded by people; however, many have been recorded as **craters** in the surfaces where they landed on the Earth or other planetary bodies. Meteor Crater in Arizona is the best known meteorite **impact crater** on Earth. It is about 50,000 years old and well preserved in the arid desert. Many small fragments of the Canyon Diablo meteorite have been found around the crater, but their total mass is only a tiny fraction of the total mass of the incoming meteorite. The force of the impact is thought to have vaporized most of the meteorite. Imagine how powerful that explosion must have been if anyone were nearby to see and feel it!

Studies of numerous observed falls, combined with field and experimental studies of impact craters, give us a general picture of the fall process. Meteorites approaching Earth come in all sizes from microscopic to gigantic. The larger the size, the fewer the number of meteorites there are. Most meteorites approach Earth at speeds of about 20-30 km/sec. They are slowed down by friction with the air as they pass through the atmosphere. The heat produced causes their outsides to melt to glass creating the **fusion crust**. The tiniest rocks and dust burn up as meteors without landing on Earth. Small meteorites like Noblesville are slowed to below the speed of sound. Larger meteorites like Allende and Sikhote-Alin don't slow down much and make sonic booms as they approach Earth at speeds greater than the speed of sound. Even larger meteorites, like Canyon Diablo that formed Meteor Crater, are hardly slowed at all by the Earth's atmosphere and hit the Earth at very high speeds, making large impact craters. No meteorite this large has fallen in recorded history. Most small to medium falls are stony meteorites and most of the larger showers and impact craters are produced by iron meteorites. Iron meteorites are stronger than stony meteorites; therefore, they don't break up as easily in space or as they pass through the atmosphere.

Many meteorites fall to Earth each year, but are not observed. Few of these meteorites are ever found. From photographic records of fireballs and smaller meteors, scientists have calculated that about 30,000 meteorites larger than 100 g fall on the Earth's surface each year. Although this sounds like a huge number, there is very little chance of a meteorite falling on you. Most of these meteorites just go unnoticed because they fall quietly during the night, in unpopulated areas, or in the ocean. However, some meteorites survive exposure at the Earth's surface and are picked up hundreds or thousands of years after they fall.

Identifying Meteorites

Finding a meteorite on Antarctic ice when there are no other rocks around is easy (if you can stand the cold!). Finding a meteorite on sand, a plowed field, or a path or road isn't hard. But finding a meteorite in a thick forest, or picking one out of a pile of Earth rocks is challenging, even for experts. There are many types of meteorites and they are found in all sizes and shapes, but most meteorites have two things in common: Outside they have dark brown or black glassy crusts and inside they contain enough **iron metal** to attract a magnet. The outer glassy crust, of the meteorite, called its **fusion crust**, is produced as the rock is heated by friction when it comes through the atmosphere. The outer part of the rock melts and forms fusion crust that often has flow marks or indentations like thumbprints. The inside stays cool and is usually light gray to black in color, but some may be tan or, if weathered and rusted, brown.

The three major types of meteorites are stony, iron, and stony-iron meteorites. These are easily distinguished by their amounts of iron metal. **Stony meteorites** are mostly **silicate minerals** with less than 25% metal, **iron meteorites** are essentially all metal, and **stony-iron meteorites** are about half silicate minerals and half metal. Iron-rich meteorites can be easily identified by their density; they feel much heavier than Earth rocks. Most stony meteorites have shiny or rusty

continued on next page

Meteorites that are collected with no visual evidence at the time of their fall are called **finds** and make up the bulk of the world's meteorite collections. Prior to 1970, about 1500 meteorite finds had been collected around the world. The discoveries of numerous meteorites in desert regions in North America, Africa and especially Australia have added hundreds of new meteorites to the collections in the last few years. But the best area in the world for collecting meteorites is the icy desert of Antarctica. In 1969, nine meteorites were found on Antarctic ice by a Japanese field team. Since then about 17,000 meteorite fragments have been found by Japanese, European, and U.S. meteorite collection teams.

Antarctic Meteorites

Antarctica is a special place for collecting meteorites. More meteorite fragments have been recovered there than from the rest of the world combined. Yet because the continent is frozen, remote and uninhabited, not a single Antarctic meteorite fall has been observed. Several factors combine to make Antarctica ideal for finding previously-fallen meteorites. The first is the ease of finding dark meteorites on ice. This aids in recovery of small and sometimes rare meteorites. The ice also helps to preserve the meteorites because they rust and weather away more slowly in cold Antarctic temperatures than in warmer climates. The next factor is the movement of the ice which concentrates meteorites that fell in different places at different times. The meteorites are enclosed in ice and move with a glacier until it comes to a rock barrier and stalls. The meteorites are later exposed at the surface as the ice gradually erodes away. This concentration makes it difficult to tell which meteorites are parts of a meteorite shower, and which are individual falls. All Antarctic meteorites are given separate names although some are later grouped as paired meteorites if data suggest that they came from a single shower. It is estimated that the 17,000 Antarctic meteorite fragments represent about 3,000 separate meteorites, or about the same as the total for the rest of the world's collection. (See Lesson 18)

The concentration process and ease of finding meteorites in Antarctica led to national and international meteorite programs organized by the Japanese, Americans and Europeans, and to yearly expeditions to collect meteorites. The Japanese JARE (Japanese Antarctic Research Expedition)





Collecting Antarctic meteorites. *This scientist is collecting a meteorite on the ice in Antarctica. The Antarctic ice aids meteorite collection by concentrating many meteorites in some areas, weathering them slowly, and making them easy to see. Scientists live and work in remote, hazardous conditions in order to recover hundreds of meteorites per year.*

program is run by the National Institute of Polar Research (NIPR) in Tokyo. The EUROMET (European Meteorite) consortium is a cooperative program among many European countries with its headquarters at the Open University, Milton Keynes, England. The American ANSMET (Antarctic Search for Meteorites) program is a collaboration among three government agencies: the National Science Foundation (NSF), NASA, and the Smithsonian Institution.

In Antarctica, meteorites are concentrated on ice fields near mountains, especially the Transantarctic Mountains. The sites are far from the few coastal research stations or from the South Pole station. The weather is extreme, with sub-zero temperatures and high winds to make life hazardous. Teams of scientists spend one to two months in this frigid environment collecting meteorites. They travel to these sites by helicopters or cargo planes, drive around in snowmobiles, and live in special polar tents. They must take almost everything they need to survive because Antarctica provides only air, frozen water and refrigeration. Despite these hazardous conditions, the teams have been highly successful in collecting meteorites. During approximately twenty years of collection, American expeditions have returned over

continued from previous page

metal flecks visible inside: almost no Earth rocks have iron metal. A few stony meteorites have no metal and are very similar to Earth rocks; these can be recognized by their glassy fusion crust. Stony meteorites are the most abundant (94%) among falls and irons are uncommon (5%). However, irons make up about half of all finds, except in Antarctica. Stony-irons are rare (1%) among both falls and finds.

The only way to be sure if a rock is a meteorite is to have it examined and analyzed by an expert. If you have a sample that might be a meteorite, you should contact a meteoriticist, geologist or astronomer at a local science museum or university.

Alternatively, you could contact a national meteorite curation center at NASA Johnson Space Center in Houston or the Smithsonian National Museum of Natural History in Washington, DC.



Antarctic ice cave. *A member of the U.S. meteorite collection team is standing outside an ice cave in Antarctica.*

Naming Meteorites

**Noblesville, Allende
Sikhote-Alin
Canyon Diablo
Gibeon, Brenham
ALH90411, EET83227**

Meteorites are named after the nearest town (Noblesville, IN) or post office so their names are often picturesque. Because meteorites have been found the world over, the list of meteorite names looks like a geography lesson. When meteorites are found far from towns, they may be named after their county of origin (Sioux County, NB), or after a nearby river (Calkalong Creek, Aus.), lake (Carlisle Lakes, Aus.) or other geographic feature (Canyon Diablo, AZ). In deserts where many meteorites are found in areas with few towns or geographic names, meteorite names include both a geographic area and sample number. For example, Acfer 287 is from the Sahara Desert in Algeria and Camel Donga 005 is from the Nullarbor region in Australia. In Antarctica, where thousands of meteorites have been collected in yearly expeditions, the names include the geographic area, year of collection and sample number. Geographic areas are often abbreviated using one to four letters. Thus ALH90411 stands for sample 411 collected in 1990 in the Allan Hills area of Antarctica. The names, locations and find dates of meteorites in the disks are given in the Meteorite ABC's Fact Sheet on page 29.

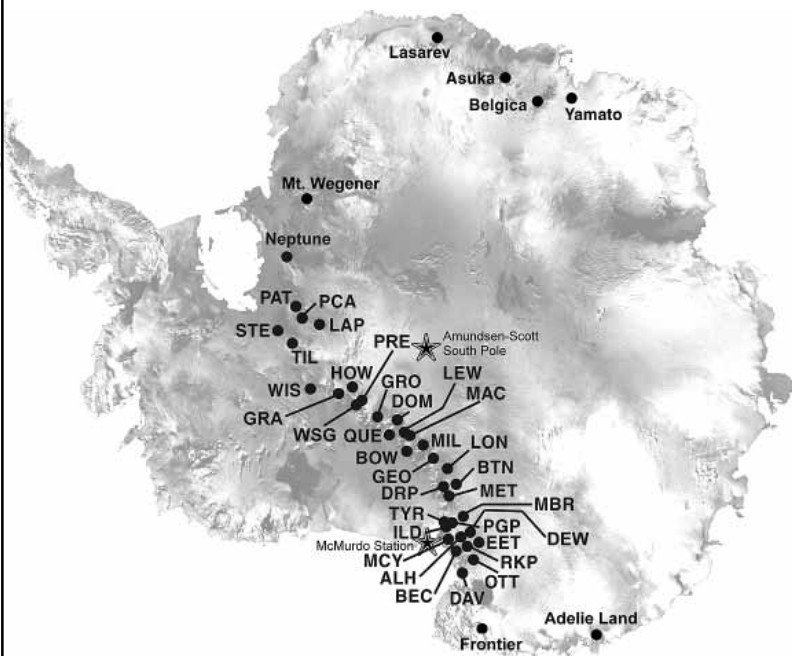

Antarctic meteorite locations. Meteorites are found mostly along the 3,000 km Transantarctic Mountains that diagonally cut the continent. These sites are remote from the U.S. research stations South Pole and McMurdo (indicated with stars).

8,000 meteorite fragments, and Japanese over 9,000. In only three expeditions Europeans found 530 meteorites.

Meteorite Curation

Scientists in museums and universities around the world are responsible for the **curation** of non-Antarctic meteorites. Curation includes classifying new meteorites, storing them, and distributing them to scientists for study. When the three Antarctic meteorite collection programs began bringing back hundreds to thousands of meteorite fragments per year, each program set up its own facilities to do curation. Each of these facilities has special clean labs because Antarctic meteorites are less contaminated by Earth's environment and pollution than other meteorite finds. Meteorites are stored in clean cabinets, sometimes in a dry nitrogen gas, and handled and examined in glove box cabinets or lab benches with filtered air. The first task of the curators is to classify new meteorites and announce them to research scientists. Scientists then send requests for samples to study. In response, the curators take small pieces of each requested meteorite and distribute them to the scientists. Finally, the curators store the meteorites in clean environments to preserve them for future studies.



Meteorite curation. This is the meteorite curation facility at NASA's Johnson Space Center in Houston, Texas. It is operated by the same group which curates the Apollo lunar samples. A companion facility is at the Smithsonian National Museum of Natural History in Washington, DC.

Micrometeorites

The smallest objects approaching Earth are **cosmic spherules** and **interplanetary dust particles (IDP)**. They are called **micrometeorites** because they are so small that a microscope is needed to see them. Because micrometeorites are small and have very large surface areas compared to their masses, they radiate heat rapidly and are not melted as they pass through the atmosphere. Cosmic spherules are droplets less than a millimeter in size that are found in deep sea sediments and Antarctic and Greenland ice. EUROMET has an active micrometeorite collection program with a curation facility in Orsay, France. IDPs are micrometer-sized irregular aggregates that vary widely in composition, mineralogy and structure. NASA collects IDP's in the upper atmosphere using military airplanes with collectors attached under their wings. The collectors are opened upon reaching high altitudes and closed before returning to the ground. This ensures that only high altitude particles are collected. Some of these particles are man-made space debris, others are ash from Earth's volcanoes, but many are interplanetary dust. These IDP's are curated at NASA Johnson Space Center in a lab adjacent to the Antarctic meteorite curation lab. NASA curators describe, announce and distribute the IDP's which are studied by scientists around the world.



Cosmic dust collection. NASA collects cosmic dust in collectors mounted on aircraft that fly in the stratosphere.

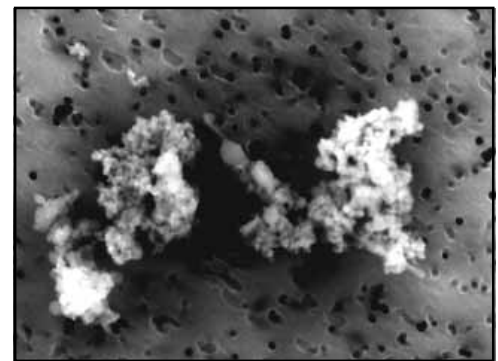

Interplanetary dust particle. This fluffy aggregate of grains was collected by NASA high in the atmosphere. It consists of a variety of minerals loosely held together. It is sitting on a metal surface with holes in it.

Impacts and Craters

Impact as a Planetary Process

One of the most significant discoveries from NASA's exploration of the solar system is the importance of meteorite impact as a planetary process. Images of the Moon, Mercury, Mars, asteroids, and the moons of the outer planets show surfaces covered with impact craters. The recent Magellan radar images of Venus revealed both craters and volcanism on that cloud-covered planet. The view of the whole Earth from space shows little effect of impact. However, from photos taken in orbits closer to Earth, scientists have identified a number of circular impact features. Meteor Crater in Arizona is the most familiar example of an impact crater. It is relatively small, young, and well preserved compared to most impact craters. Many of these craters are old; some craters are partly-filled circular lakes; others are heavily eroded. Various types of craters are illustrated in the companion slide set. A map of terrestrial impact crater locations shows that they are scattered around the Earth.

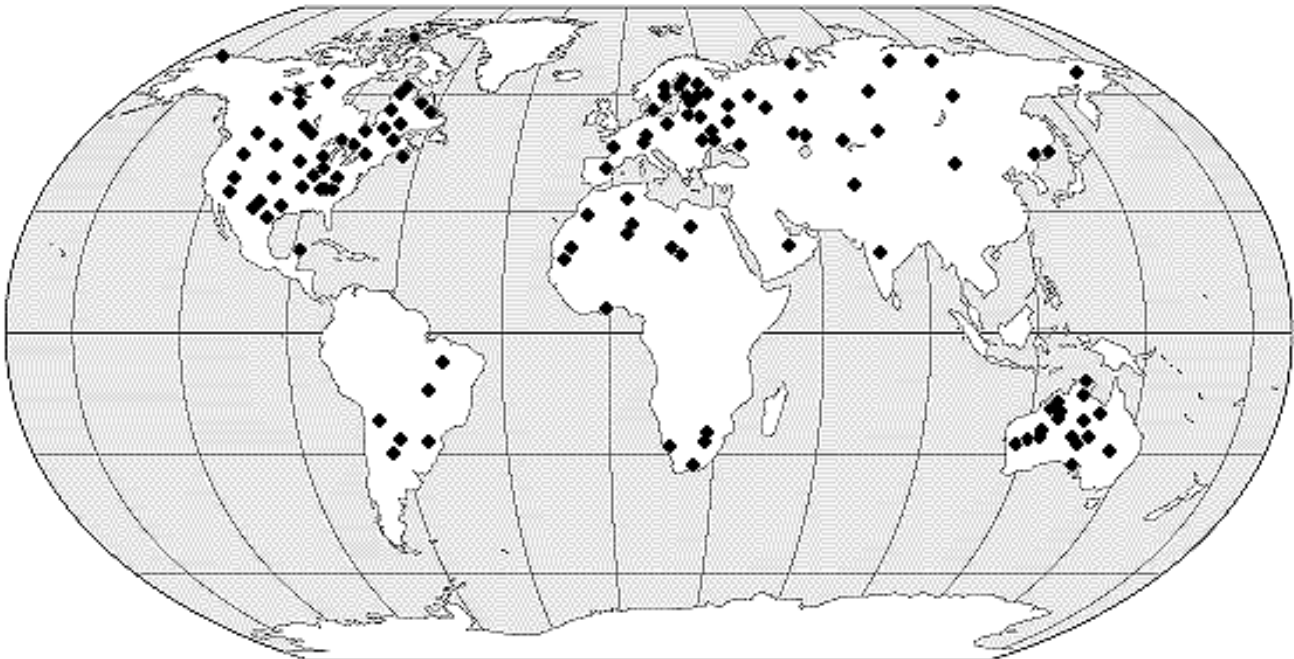

Terrestrial impact craters. This map shows locations of 140 impact craters which have been identified on Earth. The craters range in size from under 1 km to over 200 km across and in age from recent to 2 billion years old. The clusters of craters in eastern North America, Europe, and Australia are due to both stable geologic environments and active crater search programs.

Field and Laboratory Studies of Impacts

Recognizing impact craters and understanding how they form require a combination of field geology and impact experiments. The experiments define the speeds of impacting objects, structures of craters, and types of rocks formed in the impact process. Field studies of well-exposed craters provide “ground truth” for experiments and help define crater structure and the nature of rocks modified by impact. The speed of the impacting object (about 20-30 km/sec) is greater than the speed of sound in air. The object produces a sonic boom as it passes through the atmosphere and an explosion crater when it impacts. The diameter of the crater is about 10 times larger than that of the impacting object while the crater depth is about 1/10 the

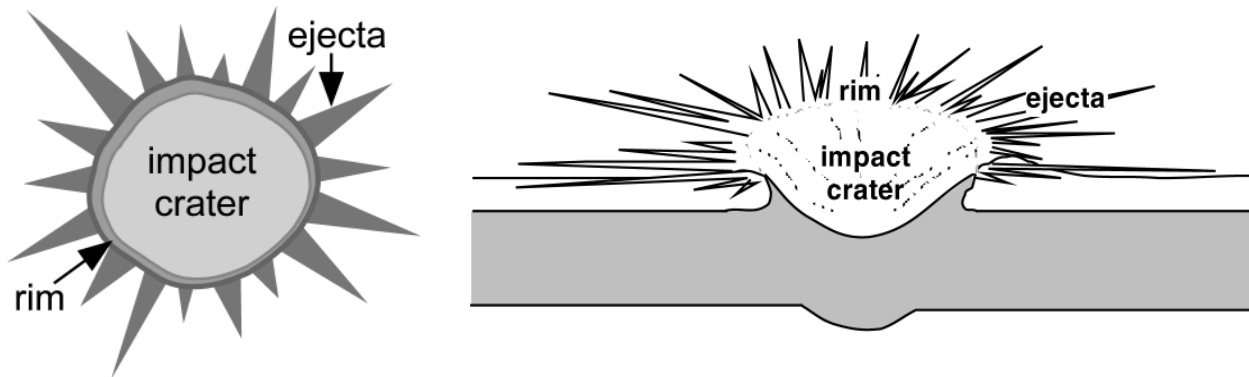

Crater cross sections. This diagram shows two views of a typical impact crater. The left view shows the circular crater with its rim and scattered ejecta. The right view shows that the rim is above and the crater floor is below the original surface. The ejecta are thickest closest to the rim.

crater diameter. These numbers vary with the speed, size, mass, and angle of approach of the impacting object, and with the nature of the target rocks.

Finding a circular crater is not sufficient to identify it as an impact crater because there are also volcanic craters. Although their size ranges overlap, impact craters tend to be larger than volcanic craters. Their structures also differ. A volcanic crater's floor is often above the surrounding surface, while an impact crater's floor is below the surrounding terrain. Thus a fresh impact crater is circular, with a raised rim and a lowered floor. Impact craters are also surrounded by rocky material thrown from the crater, **ejecta**. The best proof of an impact crater is associated meteorite fragments; after that, the next best indicator is the nature of its rocks. They are broken, distorted or even melted by the shock of the explosive impact. Much of the ejecta outside the crater is broken pieces of various rocks mixed together to form a **breccia**. The rocks inside the crater are also breccias which are highly shocked and sometimes melted. The original bedrock below the crater is shocked and fractured. (See Lessons 6 and 7)

Catastrophic Impacts

Looking at the surface of the Moon we see craters ranging in size from tiny to gigantic. The largest basins are the dark, roughly circular mare that are filled with solidified basalt. Such large impacts must have had a major affect on the whole Moon. Studies of lunar rocks returned by the Apollo missions showed that the giant impacts happened about 3.9 billion years ago (see companion volume *Exploring the Moon*). Studies also showed that the breccias formed by impact on the Moon are rich in some metals that are abundant in meteorites, but rare in rocks on the surfaces of the Moon and Earth. Iridium is one such metal that is common in meteorites. Its discovery in the K/T boundary soil offers an explanation of a catastrophic Earth event.



Aristarchus. The lunar crater Aristarchus is about 40 km in diameter. It is one of the most studied craters on the Moon.

The K/T boundary is the layer of soil that marks the end of the Cretaceous (K) period and beginning of the Tertiary (T) period of geologic time. It occurred 65 million years ago when three-fourths of all species of life on Earth became extinct. Other time boundaries in earlier periods also mark extinctions of many species. Geologists have tried to understand the causes of these mass extinctions, suggesting perhaps

major changes in climate. In 1980 geologists discovered that this layer is surprisingly rich in iridium. They suggested that the iridium was from a giant meteorite that impacted the Earth throwing a tremendous volume of dust into the atmosphere. While the immediate effects of the impact would have been regional, the effect of the dust in the atmosphere could have been global. The climate might have been changed drastically for some time after the impact. For years the impact hypothesis seemed plausible, but there were no terrestrial craters with the right age and size to have caused these changes. Recently, geologists found a 65 million year old buried crater that is over 200 km across on the Yucatan Peninsula in Mexico. It, possibly in combination with other craters the same age, might be the “smoking gun” of the K/T mass extinctions (see Lesson 14).



The Tunguska Impact. In 1908 the biggest meteor in recorded history shot across the Tunguska River in Russia and exploded. (Credit: Smithsonian Institution)

It is only natural to ask when the last large impact occurred on Earth and whether another one could occur soon. Meteor Crater was made by the impact of a large meteorite 50,000 years ago. Although it is a relatively small crater, it would have caused major destruction in a city, had there been any in existence at the time. Two medium-sized impacts occurred this century in Russia, Tunguska in 1908 and Sikhote-Alin in 1947 (see Lesson 15). The Tunguska explosion was large enough to have caused significant destruction if it had happened near a city.

The threat of global devastation from a major impact led the U.S. government and NASA to propose the Spaceguard Survey. It would have

been an international network of automated telescopes that would scan the sky in search of all Earth-approaching asteroids or comets large enough (1 km) to cause severe destruction. Once their orbits were determined, calculations would be done to predict whether any body would impact Earth. Although the full international program was not approved, there are at least two smaller programs which search the sky for incoming asteroids and comets. A means of deflecting the asteroid or comet out of its orbit would then be needed to avoid a catastrophe. Although the probability of a devastating impact is very low, the potential destruction of such an impact is so great that precautions are warranted.

The impact of Comet Shoemaker-Levy 9 on Jupiter in July 1994 was the first time scientists predicted the impact of a small body on a planet. The comet was discovered in March 1993 after it broke apart into 22 fragments as it passed close to Jupiter. The orbit of this “string of pearls” was determined by continued telescopic observation. Calculations predicted that on its next pass through Jupiter’s orbit the fragments would impact the planet. Because of the predictions, the whole world watched and waited, while thousands of

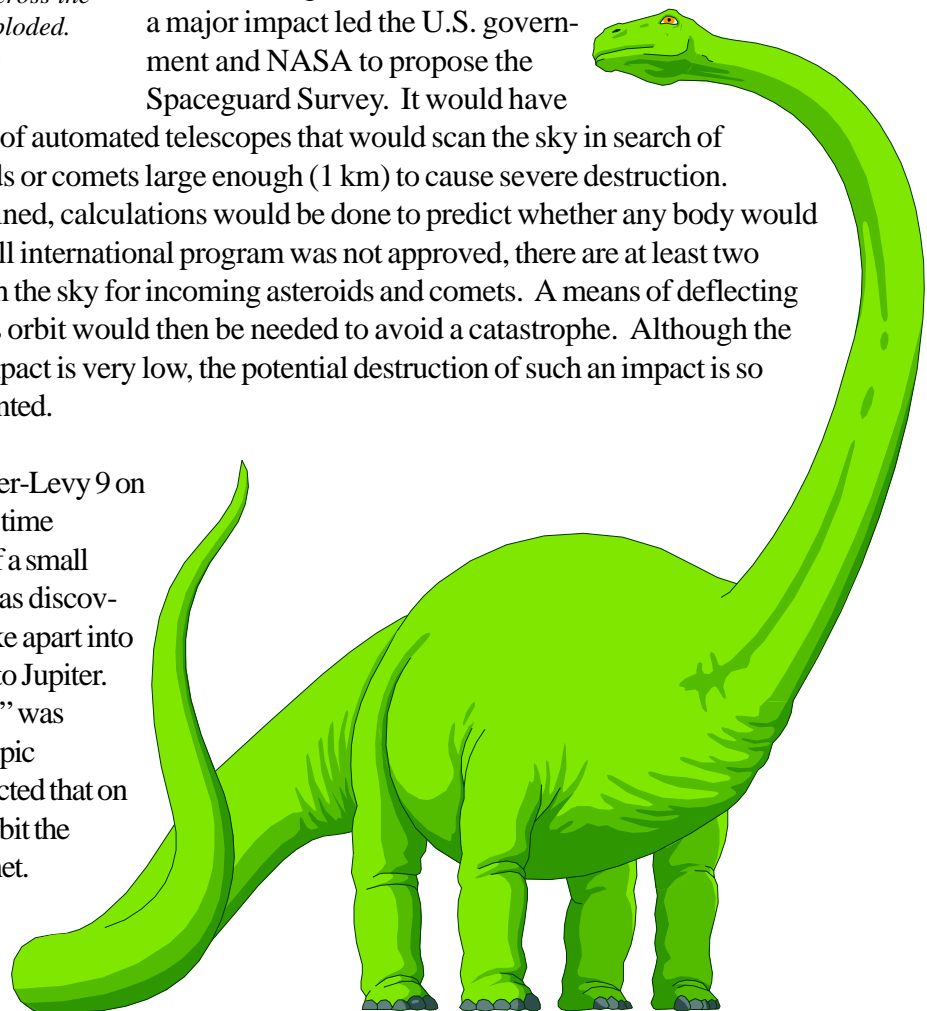

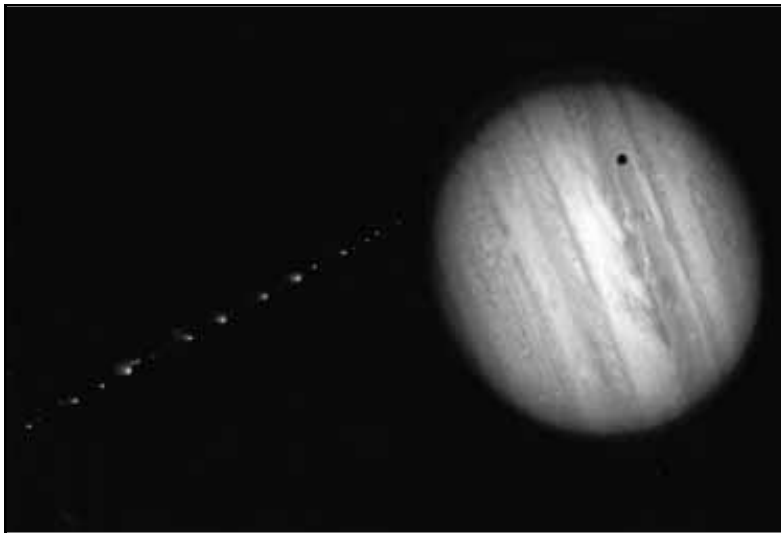

Comet Shoemaker-Levy 9 approaching Jupiter. This picture is a composite of photographs taken by the Hubble Space Telescope. The “string of pearls” is the broken pieces of comet Shoemaker-Levy 9 which were photographed during the approach to Jupiter. The collisions in July 1994 were the first predicted impacts of an asteroid or comet on a planet. (Credit: Space Telescope Science Institute.)

telescopes were aimed at Jupiter as the fragments of the comet impacted the planet on schedule. The views from the Hubble Space Telescope and from the Galileo spacecraft were even better than from large Earth-based telescopes. The successful identification of the comet and prediction of its impact allude to the potential capabilities of the Spaceguard Survey.

Meteorite Classification and Formation

Classification

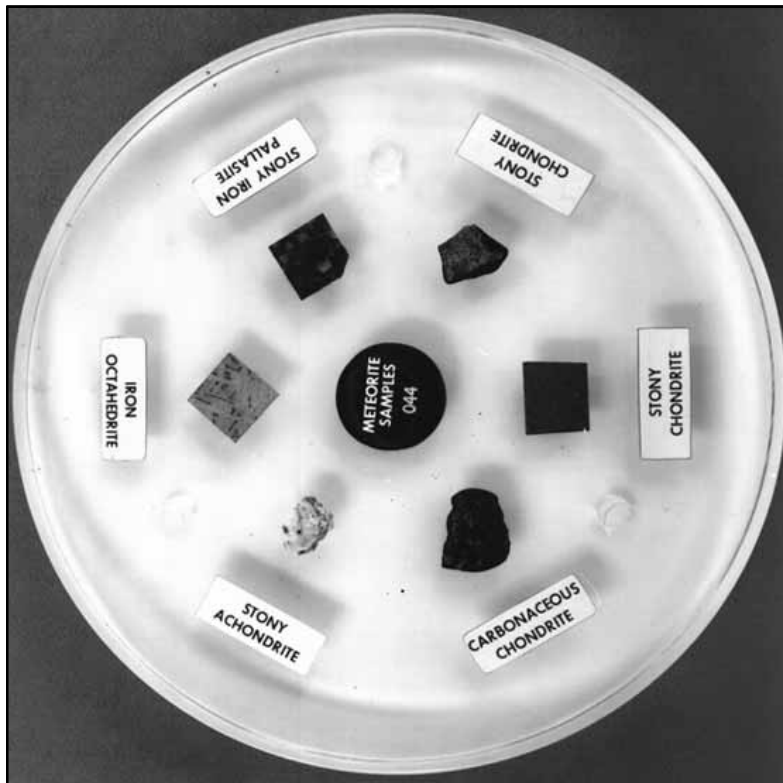

Meteorites are rocks that are made up of a variety of **minerals**. Minerals are naturally occurring crystalline materials composed of elements in defined proportions and structures. The most common minerals in meteorites are listed in the Meteorite ABC’s Fact Sheet on page 29. Most meteorite minerals are similar to those occurring in Earth rocks, but a few of the rarer minerals are found only in meteorites. Different types of meteorites have different types and proportions of minerals and different compositions. Therefore, meteorites are classified by their mineralogy and **composition**. As

Meteorite Sample Disk. The meteorite sample disk contains six different meteorite samples. See page iv for more information on using this disk in the classroom.

ALH90411 chondrite. This stony meteorite is chondrite A in the meteorite sample disk and accompanying lithographs. This sawn surface shows an irregular texture with round chondrules, broken fragments, and a little dark rusted metal. ALH90411 is a low iron chondrite and is not metamorphic.

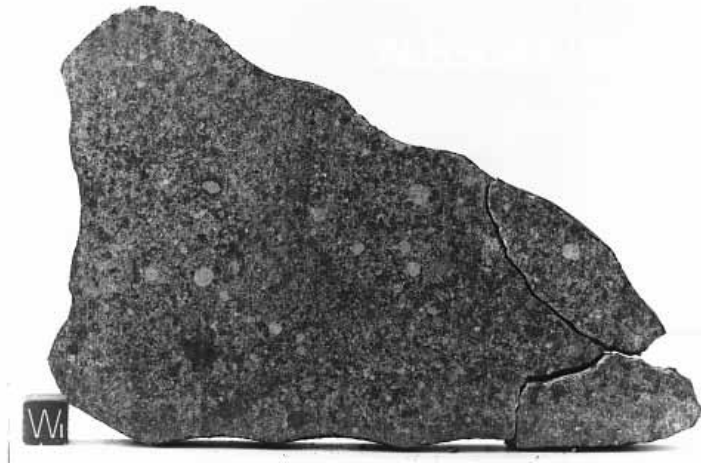

LEW87030 chondrite. This stony meteorite is chondrite B in the meteorite sample disk. It has a more uniform texture than ALH90411 and indistinct chondrules (vertical streaks are saw marks). It also has lots of shiny metal. LEW87030, like Noblesville, is a high iron, metamorphic chondrite.



discussed in the section on identifying meteorites, the simplest classification of meteorites into **stony**, **iron**, and **stony-iron** types is based on the amount of iron metal and **silicate minerals** in the meteorite. It is relatively easy to tell whether a sample has little metal, is mostly metal, or is about half metal and half silicate minerals. This can be determined by looking at the amount of metal and silicate minerals in the sample's interior and by hefting it to feel its density because iron metal is about twice as dense as silicate minerals.

Each of the three major types of meteorites shows considerable variability and is further subdivided based on mineralogy and composition. Meteorite **classification** is complex because of the diverse possibilities. Meteorites represent many different rock types and probably come from different bodies in the solar system. However, after detailed studies, some meteorites of different types appear to be related to each other and possibly come from the same solar system body. A simplified listing of meteorite types is given in the Meteorite ABC's Fact Sheet.

Stony meteorites are divided into **chondrites** and **achondrites** based on whether they contain small round balls of silicate minerals called **chondrules**. Chondrites contain chondrules and achondrites do not. Chondrites are the most abundant type of meteorites, making up nearly 90% of both falls and Antarctic meteorites. Chondrites are divided into several classes, including **ordinary chondrites**, the most common, and **carbonaceous chondrites**, perhaps the most interesting because of their potential to tell the earliest history of the solar system.

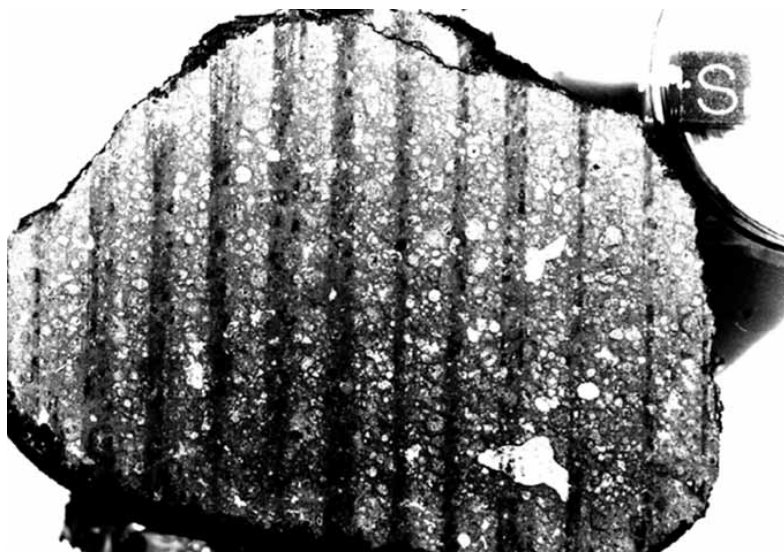

***ALH84028 carbonaceous chondrite.** This stony meteorite has a highly irregular texture with distinct round chondrules, white inclusions, and little metal in a dark carbon-bearing matrix (vertical streaks are saw marks). It is a carbonaceous chondrite similar to Allende, the carbonaceous chondrite in the meteorite sample disk.*



***RKPA80224 basaltic achondrite.** This stony meteorite contains no chondrules or metal and is an achondrite. Basaltic achondrites consist of feldspar (white mineral) and pyroxene (dark mineral) and are similar to basalts that formed from lavas on Earth and the Moon. This sample has an igneous texture showing that it crystallized from a melt. Other basaltic achondrites have the same mineralogy and composition, but are breccias containing broken rock fragments. The achondrite in the meteorite sample disk, EET83227, is a basaltic achondrite breccia.*

Ordinary chondrites consist of variable amounts of metal and chondrules in a matrix of mostly silicate minerals. The silicates are mostly olivine and pyroxene, with minor feldspar. Further subdivisions of ordinary chondrites are based on the amount of iron metal and the variability in composition and texture. Some are high iron chondrites, others are low or very low iron types. Chondrites which have distinct chondrules and variable mineral compositions have not been heated since they formed and are non-metamorphic chondrites. Metamorphic chondrites have indistinct chondrules and constant mineral compositions and have been changed since their initial formation.

Carbonaceous chondrites are a very special meteorite class because they are the most primitive meteorites and they contain water and **carbon compounds**. These chondrites consist mostly of the silicate minerals olivine and pyroxene or clay minerals that formed from them by weathering. Carbonaceous chondrites contain very little metal, but contain unusual inclusions, and 2-20% water in their clay minerals. The carbon occurs in elemental form as graphite and occasionally diamond, and in **organic molecules** which range from simple molecules to **amino acids**, the building blocks of DNA and life. Carbonaceous chondrites show variations in composition and degree of metamorphism and weathering.

Achondrites are the second most abundant type of meteorites (8%) and many are similar to igneous rocks on Earth. Achondrites are divided into several classes, of which the most abundant is **basaltic achondrites**, and the most unusual is **planetary meteorites**. The basaltic achondrites are actually a family of three distinct subclasses that are grouped together because they appear to be related to each other. The most common are pyroxene-feldspar igneous rocks similar to basalts on Earth. Many of these basalts were broken up by impacts so that the meteorites are breccias made up of basalt fragments. Another type consists mostly of pyroxene and may have formed by accumulation of minerals sinking in a magma. The

Gibeon iron meteorite. This photo shows a sawed surface which has been etched with acid to reveal the criss-cross Widmanstatten pattern. The Gibeon iron meteorite in the sample disk and the Sikhote-Alin meteorite have fine intergrowths of iron-nickel metals.

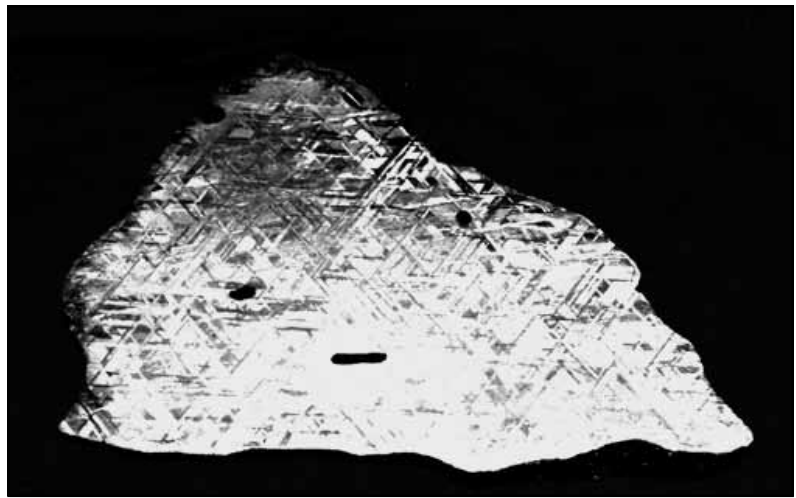

Brenham stony-iron meteorite. This stony-iron meteorite consists of yellow-green olivine crystals surrounded by iron-nickel metal. It is a cumulate stony-iron and is used in the meteorite sample disk.

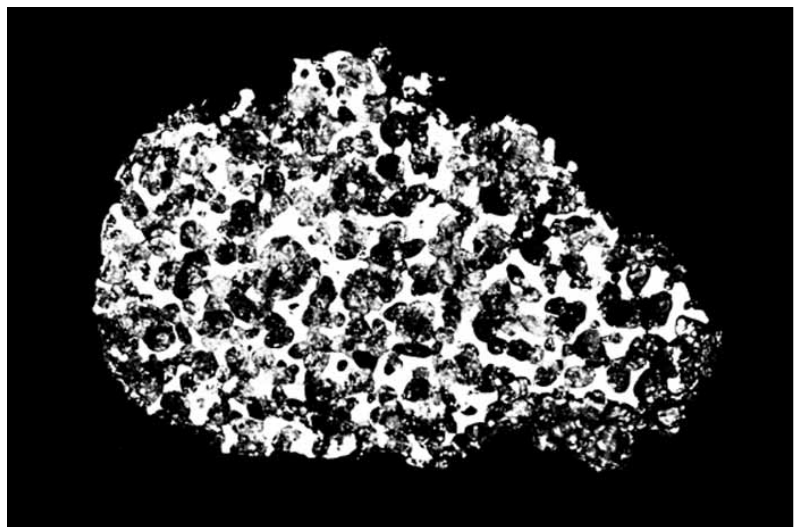

third type are complex breccias made up of fragments of the other two types. These meteorites formed by impact mixing on the surface of a parent body.

Planetary meteorites are a recently recognized class of achondrites which include both lunar and martian meteorites. They are igneous rocks and breccias that formed from igneous rocks. Their compositions and mineral proportions range widely. Some are basalts that crystallized as lavas. Others are cumulates, rocks that formed by accumulation of minerals floating or sinking in magmas. These include lunar anorthosite breccias which formed by feldspar floating (see companion volume *Exploring the Moon*) or martian cumulates which formed by pyroxene and olivine sinking. More lunar and martian meteorites have been found in Antarctica than in the rest of the world.

Iron meteorites, which make up only 5% of meteorite falls, consist almost entirely of iron-nickel metal with variable amounts of sulfides and occasional inclusions of silicate minerals. Iron meteorites usually consist of two distinct iron-nickel minerals, kamacite (high iron) and taenite (high nickel) which are intergrown to form a criss-cross Widmanstatten pattern which can be seen when the sample is etched lightly with acid. Irons are subdivided both by the texture of this intergrowth and by the composition of trace elements in the metal. However, the textural and compositional subdivisions do not correlate well. Some groups of iron meteorites may be related to basaltic achondrites.

Stony-irons, which are the least abundant major type of meteorites (1%), include both cumulate and breccia varieties. The cumulates consist of metal and the silicate mineral olivine, where the olivine grains are large and surrounded by metal grains. The metal and silicates formed by slow cooling of heavy phases from a melted body. The metal and silicate grains in the stony-iron breccias are usually much smaller than in the cumulates, and the texture is a complex mixture of broken fragments imbedded in matrix. The silicate fragments are similar to those in basaltic achondrites. Both cumulate and breccia stony-irons may come from the same bodies as basaltic achondrites.

Meteorite Research

Many different types of science are involved in the study of meteorites, their formation and their sources. Meteorite research bridges the gap between geology, the study of Earth's rocks and landforms, and astronomy, the study of the Sun, planets, moons, and stars in space. **Planetary geology** is a new science which began when we were first able to study the Moon and other planets up close. Planetary scientists study the planets and other bodies in the solar system using photographs and chemical or physical data collected from flyby and orbiting spacecraft or robotic landers: Voyager, a flyby craft, explored the outer planets; the orbiter Magellan focused on Venus; Viking studied Mars with both orbiters and robotic landers. The Apollo missions to the Moon provided the only chance so far for humans to walk on another planetary body, to study the landforms, and to bring rocks back to Earth for detailed analyses (see companion volume *Exploring the Moon*).

Meteoriticists are scientists who study meteorites. They may be trained in geology, chemistry, physics, or astronomy because all these fields are needed to understand meteorites and their relationships to bodies in the solar system. Meteoriticists often work in teams so that specialists in several different fields contribute to the research. Mineralogists study the mineralogy and textures of thin slices of rock; chemists analyze rocks for their elemental and isotopic compositions and determine ages; physicists measure physical properties such as magnetism.

To learn about the relationship of meteorites to planetary bodies, astronomers try to match meteorites with possible sources. Planetary geologists study impact craters on Earth, the Moon and planets to understand the

impact process. Other scientists do not study meteorites or planetary bodies directly, but do experiments in laboratories to simulate the processes of meteorite formation or impact. NASA funds most of the research on meteorites that is done in the U.S. through grants to investigators at universities, industry, and government laboratories.



Meteorite research. *This scientist is working at a scanning electron microscope. With this instrument the scientist can look in detail at the mineralogy, composition, and physical structure of meteorites.*

Processes of meteorite formation. This diagram illustrates several meteorite formation processes. The first processes are condensation from a gas to a solid (not illustrated) followed by accretion of small particles to form an asteroid or planet. When the accreted body is heated, it is modified by metamorphism or differentiation. Even if heating is not enough to melt the body, it may undergo metamorphic processes which make the texture and mineral compositions more uniform. If heating melts the body, it may undergo differentiation: Metal separates from the silicate melt and sinks under the influence of gravity to form the core. Silicate minerals crystallize and heavy minerals, like olivine and pyroxene, sink to form the mantle, while light ones, like feldspar and some pyroxene, float to form the crust. Volcanism (not illustrated) brings basalts to the surface to add to the crust. Weathering (not illustrated) alters the surface rocks through chemical or physical changes. Finally, impacts on a variety of bodies break off fragments that may fall to Earth as meteorites.

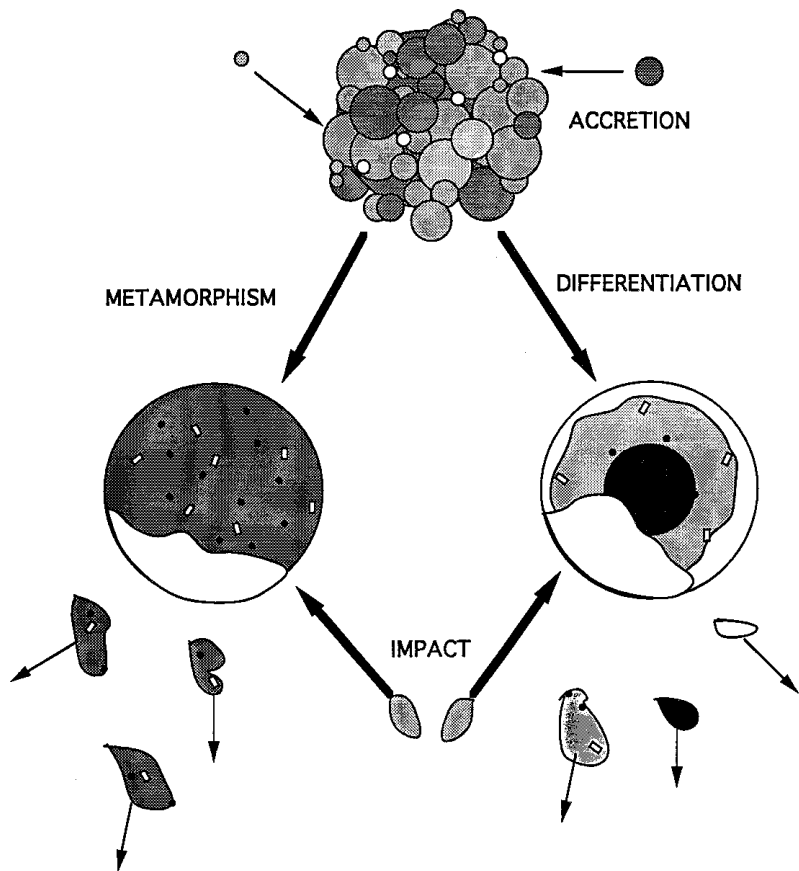

Formation Processes

The processes of meteorite formation have been identified by comparing studies of meteorite mineralogy, composition and ages with those of Earth and Moon rocks, and experimental results. On Earth, rocks form by **igneous, metamorphic** and **sedimentary** processes, but the continued action of these processes has erased all evidence of Earth's initial formation. Meteorites bear evidence of the history of the solar system from its initial formation to recent volcanism and impacts on Mars. Chondrites are primitive objects formed at the beginning of the solar system and changed by metamorphic and sedimentary processes. Achondrites, irons, and stony-irons are differentiated objects formed by igneous processes and changed by impacts and metamorphism. Evidence for these processes is listed on the Solar System ABC's Fact Sheet on page 31. Many of the details of the processes are not fully understood — hence meteorite research continues — but enough is known to present a general story of meteorite formation.

The evidence for the primitive nature of chondrites is found in their ancient ages, Sun-like compositions, and unusual minerals and textures. All chondrites are 4.5-4.6 billion years old. They are the oldest rocks in the solar system and are used to date the beginning of the solar system. Chondrite compositions are very similar to that of the condensable part of the Sun without the gaseous elements, H and He. Carbonaceous chondrites are most similar to the Sun's composition because they contain volatile components such as water and carbon compounds. Chondrites tell us about formation of solid bodies from the cloud of gas and dust called the solar nebula. Carbonaceous chondrites contain stardust and white inclusions. Stardust is composed of minerals such as diamond and silicon carbide which are thought to have formed in a red giant star before our Sun was formed. The white inclusions consist of unusual minerals which were the first minerals to condense from a gas in the formation of the solar system. This **condensation** is the first stage in solar system formation. The gases in the solar nebula gradually condense as it cools to produce the minerals

found in meteorites, first the white inclusions, then silicate minerals. Chondrules are melted and crystallized spheres of silicate minerals which are thought to have formed by flash heating as the solid matter in the solar system condensed.

Accretion is the physical process of building up chondrites and planetary bodies by collecting together smaller pieces of unrelated materials such as chondrules, white inclusions, stardust, and volatile components. The variations in chondrite mineralogy and composition show that there were areas in the early solar system with different compositions or temperature and pressure conditions. Inverse variations in the amount of iron in metal versus iron in silicate minerals suggest that there were variations in oxidation state for different chondrite types. Variations in volatile contents suggest that the volatile-rich carbonaceous chondrites accreted at lower temperatures than volatile-poor ordinary chondrites. (See Lesson 10)

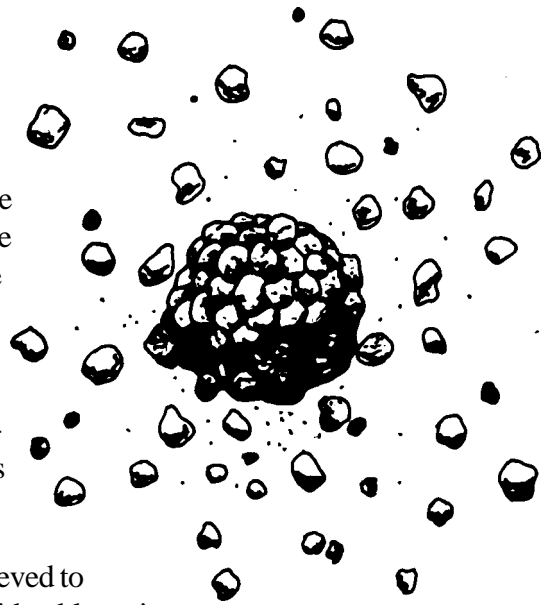

The organic compounds in carbonaceous chondrites are believed to have formed very early in solar system history. There is considerable variety in organic compounds in carbonaceous chondrites, from simple molecules to amino acids, but apparently none were formed by living organisms. The evidence for this is in the symmetry of the organic compounds which are found in both right- and left-handed forms in meteorites, while similar compounds formed by living organisms on Earth are found only in one form. (See Lesson 12)

After condensation and accretion, most chondrites were changed by **metamorphism** and **weathering**. Heating of originally heterogeneous chondrites to temperatures below their melting points caused the mineral compositions to homogenize and chondrules to fade into the matrix. Heating of carbonaceous chondrites allowed their water to weather the olivine and pyroxene silicates to clay minerals. This was the first weathering in the solar system, an Earth-like sedimentary process that took place near the beginning of the solar system.

Differentiated meteorites (achondrites, irons, stony-irons) have compositions very different from those of the chondrites or the condensable part of the Sun. However, if their compositions are recombined in the relative proportions in which they fall to Earth, the average differentiated meteorite composition is a lot closer to chondrite composition. Most differentiated meteorites are also ancient rocks 4.4-4.5 billion years old, nearly as old as the primitive chondrites. The only exceptions are planetary meteorites which have ages ranging from 180 million years through 4.5 billion years. Although many differentiated meteorites are breccias broken and mixed by impacts, it is apparent that most are rocks that originally crystallized from melts and formed by igneous processes.

The suite of differentiated meteorites is evidence of early **differentiation** on asteroids (and planets) into **core**, **mantle** and **crust**. Heating of the body to above the melting temperature allowed separation of iron and silicate melts and later separation of crystallized minerals. Iron meteorites represent the core of the asteroid which formed by slow cooling from an iron melt to produce the intergrown iron-nickel minerals. Stony-iron cumulates come from the core-mantle boundary where iron melt surrounded olivine silicate minerals. Basaltic achondrites are mostly from the crust of the asteroid, with cumulates possibly from the upper part of the mantle. Basaltic achondrites flowed as lava onto the surface, just like basaltic lavas produced by **volcanism** on the Earth, Moon, and Mars. Finally, breccias of basaltic achondrites and stony-irons represent the soil and rocks at the surface of an asteroid where various rock types are broken and mixed by **impacts**. (See Lesson 11)

Meteorite Sources

Meteorites from Asteroids

Meteorites are “rocks from space,” but there’s a vast area of space out there. Our Sun is just one of billions of stars in the Milky Way galaxy, which is one of billions of galaxies in the universe. Luckily, we don’t have to search all of outer space for the sources of meteorites because scientists think that meteorites come from our own “backyard,” from the **asteroids, comets**, moons and planets in our solar system (see Solar System ABC’s Fact Sheet).

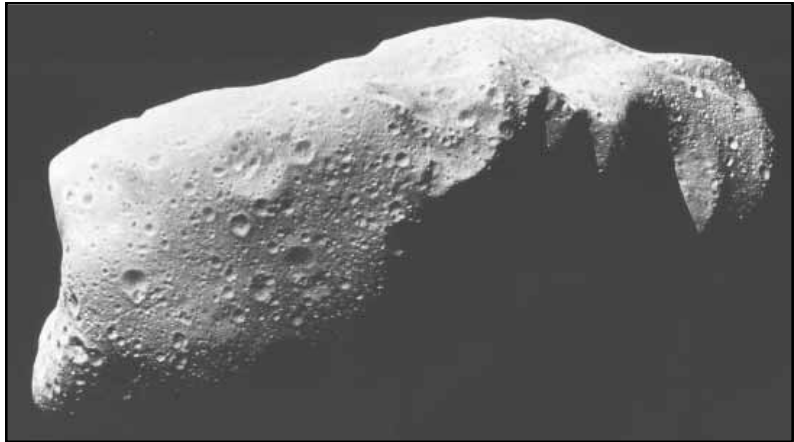

Asteroid Ida. This photograph of 52 km asteroid 243 Ida was taken in 1993 by the Galileo mission. The asteroid is a rocky body that is irregular in shape and covered with impact craters.

Most meteorites appear to come from asteroids, the small (diameter less than 1000 km) rocky bodies that orbit the Sun in the region between Mars and Jupiter, but are mostly concentrated in the **asteroid belt** between 2.2-3.2 AU (astronomical unit, the mean distance between the Earth and Sun). The evidence that most meteorites come from asteroids is based on comparison of meteorite and asteroid **orbits** and mineralogies. Three meteorites have been observed photographically as they approached Earth. It was possible to calculate the orbits of the Innisfree, Lost City, and Pribram meteorites from a series of timed photographs. These are all elliptical orbits that extend from Earth back to the asteroid belt. (See Lesson 4)

Asteroids are so small and far away that telescopes on Earth see them only as points of light. Astronomers find asteroids by studying telescopic images and looking for the objects that move compared to the stationary star field. Long exposure photographs show a background of stars as bright spots with a streak of light from an asteroid caused by its movement across the sky. To calculate the orbit of an asteroid, one must measure its position at several different places and times, but it is not necessary to follow it through an entire orbit. Asteroidal orbits are ellipses rather than circles (see Lesson 4), but most orbits are not too far from circular and therefore stay within the asteroid belt and do not cross the orbits of the planets. A few asteroids, such as Aten, Apollo, and Amor, have highly elliptical orbits that cross the orbits of Earth or Mars, while others like Hector are in the orbits of Jupiter or beyond. Gravitational interactions with Jupiter, and impacts between asteroids in the belt may break them up and send the resulting fragments into planet-crossing orbits.

Ceres, the largest asteroid (almost 1,000 km) was the first asteroid found in 1801. Since then over 6,000 asteroids have been catalogued. Most asteroids are very small, only three are larger than 500 km, and only about 25 are larger than 250 km. All of the Earth- and Mars-crossing asteroids are smaller than 30 km. Our first close up look at asteroids was provided by the Galileo spacecraft that flew by and photographed asteroids Gaspra in 1991 and Ida in 1993. Both are irregular masses of rock, seemingly broken and covered with impact craters. Phobos and Deimos, the moons of Mars, look very much like asteroids in size and shape. The next planned asteroid encounters are part of the NEAR mission. It will fly by asteroid Mathilde in summer 1997 and orbit and map asteroid Eros in 1999. The Solar System ABC’s Fact Sheet gives information for twenty asteroids in order of distance from the Sun. It gives examples from each of the groups of planet-crossers and several of the larger asteroids that populate the asteroid belt.

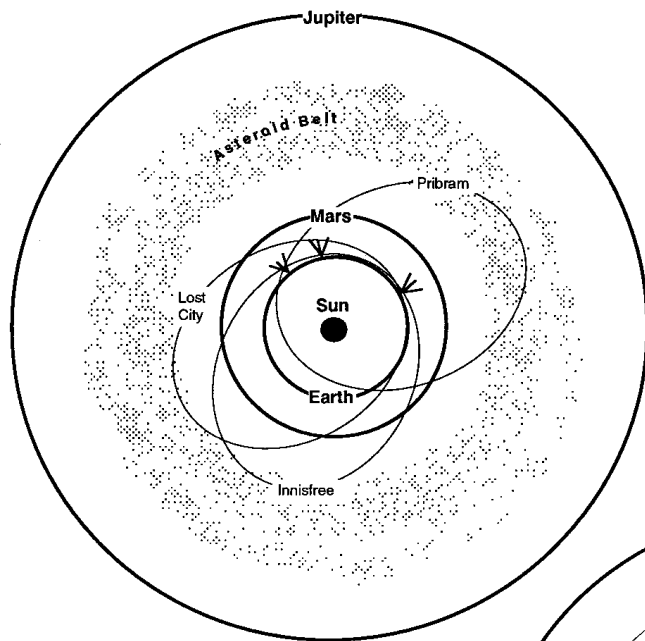

Meteorite and asteroid orbits. Orbits of meteorites and asteroids compared to those of Earth, Mars and Jupiter. (Top) The orbits of three meteorites, Innisfree, Lost City and Pribram, were calculated from series of timed photographs taken as each meteorite fell to Earth. (Bottom) Orbits of seven asteroids are shown. The three closest to the sun, Aten, Apollo and Amor, are elliptical and cross the orbits of Earth or Mars. The next three, Vesta, Ceres and Hygeia, are in the asteroid belt where most asteroids are found. The last one, Hector, is in Jupiter's orbit, but spaced far enough from the planet that it does not impact Jupiter.

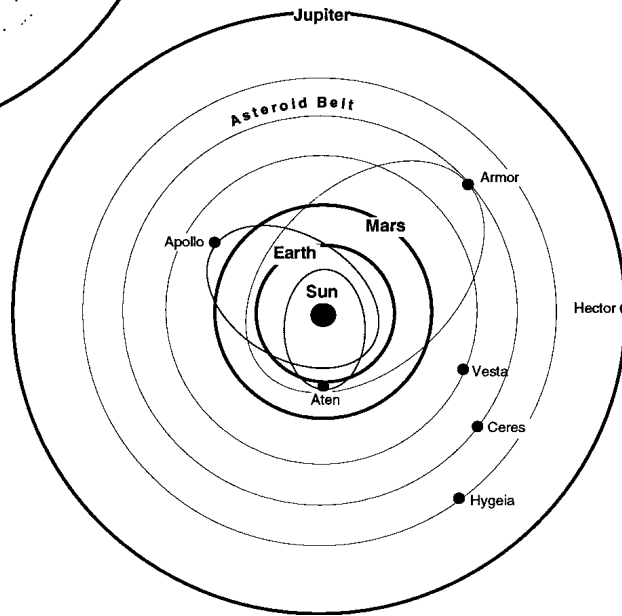

Astronomers study different types of asteroids using the brightness and color of light they reflect. This is called **reflectance spectroscopy**. Asteroids are divided into several classes (indicated by letters) based on their overall brightness and reflectance spectrum. E asteroids are very bright, S and M asteroids are moderately bright, and C and D asteroids are dark. U asteroids are unusual and varied. E, M, and U asteroids are rare, while S and C asteroids are common. The asteroid belt appears to be zoned, with most of the S asteroids in the inner part of the belt, C asteroids in the central to outer belt, and D asteroids only in the outer belt. (See Lesson 5)

The spectrum of reflected light at different wavelengths is caused by the mineralogy on the surface of the asteroid. If we have reflectance measurements of appropriate mineral and rock standards, we can determine the mineralogy of an asteroid by matching it to that of the standards. In this way we find that E asteroids are rich in iron-free pyroxene, M asteroids are rich in metal, C and D asteroids are rich in carbon, S asteroids are mixtures of metal and silicates, and Vesta, one of the U asteroids, is made of basaltic rock. When compared to meteorites, fairly good matches between asteroid and meteorite classes are found. E asteroids match a special class of achondrites, M asteroids match irons and stony-irons, Vesta matches basaltic achondrites, C and D asteroids match carbonaceous chondrites. However, S asteroids are not a very good match for ordinary chondrites. Also, there is a problem that the most abundant type of asteroid in the inner asteroid belt does not match the most common type of meteorites. Our knowledge of the

relationships between asteroids and meteorites is still incomplete. Nevertheless, there is a general relationship between meteorites and asteroids, and a zoning in asteroid types in the asteroid belt. This suggests that asteroids represent the transition in formation from rocky inner planets to volatile-rich, outer planets.

Meteorites from Comets

Comets are small (1-10 km) balls of ice and dust that spend most of their time in the frigid outer solar system, but make spectacular displays when their highly elliptical orbits bring them into the warmer inner solar system. The Sun's heat produces a gaseous coma around the solid nucleus and long tails of gas and dust that can be seen by the naked eye. Periodic comets, like Halley which appears every 76 years, have elliptical orbits centered near Jupiter and Saturn and periods of less than 200 years. Most comets have very long periods (>10,000 y) and have visited the inner solar system only once in recorded history. They have nearly parabolic orbits and spend most of their time in the Oort cloud far beyond the orbit of Pluto. Comets Hyakutake and Hale-Bopp that visited the inner solar system in 1996-97 have periods of 65,000 years and 4,200 years, respectively.

Comets are considered to be the most primitive bodies in the solar system. They are "dirty snowballs" consisting of water, methane and ammonia ices mixed with silicates and a little metal dust. They are thought to have formed in the region around Uranus and Neptune, but were moved to new orbits by gravitational interaction with the planets: Periodic comets we see today were moved inward toward Jupiter and Saturn. Most comets, however, were thrown outward beyond the planets to form the Oort cloud.

Comets are clearly related to periodic meteor showers. Almost all periodic showers occur when Earth crosses the orbit of a periodic comet. Meteors are produced as cometary particles of dust and gas are burned up in the Earth's atmosphere. The Solar System ABC's Fact Sheet lists several comets and their associated meteor showers. The relationship between comets and meteorites is less certain. Since the compositions of comets and interplanetary dust particles are quite similar, comets are thought to be the sources of IDP's. Comet composition is also somewhat similar to that of some carbonaceous chondrites; a relationship with them is possible, although much less certain. Until we have more detailed information on the nature and composition of comets, either from robotic landers or comet sample return missions such as the Stardust mission to comet Wild 2, we will not know with certainty whether comets are the sources of carbonaceous chondrites.

Comet Halley. This photograph of Comet Halley and a meteor, which appears as a streak, was taken on January 7, 1986 at the Mount Palomar Observatory. The inset is an image of the nucleus of Comet Halley taken by the European Space Agency's Giotto spacecraft shortly before closest approach.



Meteorites from the Moon and Mars

The surfaces of the Moon and the rocky inner planets show many craters caused by meteorite impact. Could some of these impacts have ejected material into space that might later fall to Earth as meteorites? Before the Apollo lunar landings a few scientists thought that meteorites might come from the Moon. But none of the lunar rocks returned by six Apollo missions in 1969-1972 resembled meteorites. It was ten years later when the first lunar meteorite, ALHA81005, was identified in Antarctica. Although not identical to any specific Apollo sample, this achondrite is an **anorthosite** breccia that is very similar to many samples collected in the lunar **highlands** (see companion volume *Exploring the Moon*). Since 1982, a total of fifteen lunar meteorites have been identified. These meteorites include anorthosite breccias from the highlands and **basalts** and breccias from the lunar **mare**.

The identification of martian meteorites is a space detective story. Because we have not yet returned samples from Mars we have to rely on what we learned from robotic exploration and our understanding of rocks from the Earth, Moon and asteroids. In 1976 the Viking mission provided our first detailed look at Mars using two orbiters which photographed the whole surface and two landers which analyzed the atmosphere and soil.

The intensive studies of lunar samples and meteorites in the 1970s led to general models for planetary differentiation and evolution. Small bodies like asteroids differentiated early, if at all, and their heat engines died shortly after solar system formation. Hence asteroidal meteorites, including basaltic achondrites, are close to 4.5 billion years old. Larger bodies like the Moon and planets stayed active longer and have



***Moon.** This photograph of the Moon was taken during the Apollo 17 mission. The light areas are highlands that are covered mainly with breccias rich in anorthosites. The dark areas are maria that are covered with basalt lavas.*



***Lunar meteorite ALHA81005.** This 31 g (ping pong ball-sized) meteorite is a breccia rich in light colored anorthosite fragments melted and mixed together by impacts in the lunar highlands. Other lunar meteorites are dark colored basalts from the mare. The scale is 1 cm across.*



Mars. This picture of Mars is a composite made from many photos taken during the Viking mission. The crack across the middle is a canyon as long as the United States. The dark circles at the left are huge volcanoes that are the largest in the solar system.

younger rocks on their surfaces, such as lunar basalts which are 3-4 billion years old. The Earth is obviously still producing igneous rocks today.

When geochemists discovered the SNC family, a group of achondrites which were 1.3 billion years old or less, they argued that they must be from a body larger than the Moon, perhaps Mars. The absence of lunar meteorites was used to argue that it was not possible to get meteorites off the surfaces of planets. The argument was if you couldn't get meteorites from the Moon with its lower gravity and closer distance, you couldn't get them from Mars. The discovery of first one, and then several, lunar meteorites refuted that argument. The definitive clues to a martian origin were found by comparing the meteorites to the Viking lander measurements. The martian soil had the composition of weathered basaltic rocks similar to the basaltic SNC meteorites. But the real clincher was the discovery that gases in one meteorite, EETA79001, had compositions identical to those Viking measured in the martian atmosphere. The rock actually had martian atmosphere trapped inside. In all there are twelve martian meteorites and all of them are igneous rocks, either basalts or olivine and/or pyroxene cumulates.



Martian meteorite EETA79001. Remains of dark fusion crust, created during high speed entry through Earth's atmosphere are visible.

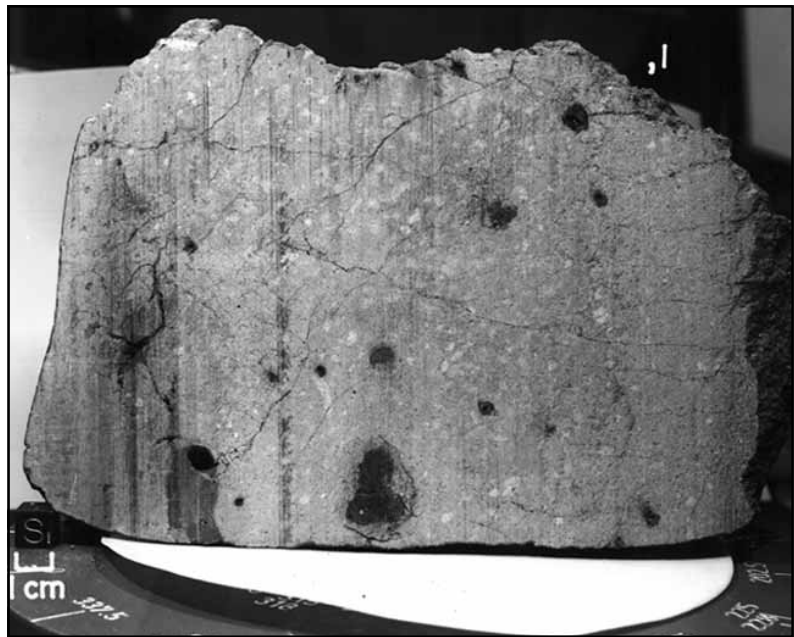

Martian meteorite EETA79001. This 8 kg (soccer ball-sized) meteorite is a basalt similar to, but distinct from, basalts on Earth, the Moon, and the basaltic achondrite asteroid. It has dark glass-lined holes which contain gases with compositions the same as those measured in the martian atmosphere by the Viking lander.

Brief History of the Solar System

Our geological understanding of the history of the solar system has been pieced together by geologists and astronomers based on numerous studies of the large bodies and rocks in the solar system. Many different scientists participated in the study of the Earth, Sun, Moon, planets, asteroids, and comets. Some studied the astronomical bodies with telescopes; others did geology with orbital data and photographs; and still others studied the mineralogy, composition, and ages of Earth and Moon rocks and meteorites. These studies have revealed a series of processes in solar system history: condensation, accretion, differentiation, volcanism, metamorphism, weathering, and impact.

These processes have taken place throughout the rocky inner solar system, but the duration and extent of the last four processes depend on the solar system body. Therefore, different bodies and their rocks provide evidence for different processes in solar system history. This evidence is tabulated in the Solar System ABC's Fact Sheet, page 31.

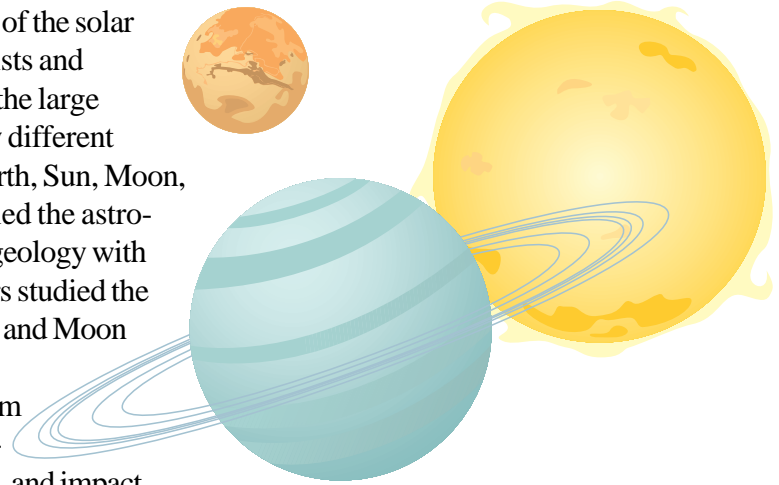

The Earth, Moon and Mars have no evidence remaining of initial planet formation by condensation and accretion. Primitive chondrite meteorites provide the evidence for the beginning of solar system history. Iron, stony-iron meteorites, lunar anorthosites, and seismic studies of Earth's interior structure provide evidence of early differentiation into core, mantle, and crust. Basalts are products of volcanism on all types of rocky bodies. Changes in the original mineralogy and composition of rocks were produced by metamorphism, weathering and impact on various bodies to different degrees.

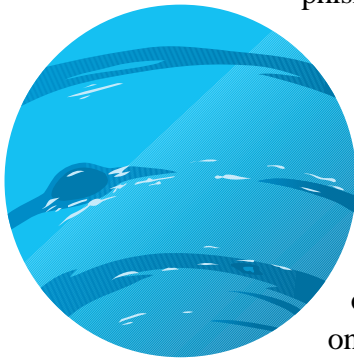

Dating these events can be done in both relative and absolute ways. Relative dating on Earth is done in layers of rock where the rock on the bottom is presumed to be older than the rock on the top (unless there is evidence that the whole unit is turned over). However, when comparing meteorites or rocks from various planets these relationships are not available so absolute dating must be used. Absolute dating of rocks is based on radioactive decay of some elements with very long half-lives. The process that is dated depends on whether the rock was changed by later processes and how extensive those changes were. For example, if we want to date the initial formation of a meteorite (accretion of a chondrite or crystallization of a basaltic achondrite) the sample should be one that has not been extensively changed by metamorphism or weathering.

A solar system timeline based on dating of many meteorites and rocks from both Earth and Moon is given in the Solar System ABC's Fact Sheet. Like layers in rocks on Earth, the youngest events are at the top, the oldest are at the bottom. Although scientists don't fully understand all of these formation processes, they do know generally what happened and when. Some of these processes took place at about the same time on different bodies in the solar system. Some processes took place once and were finished. Sun and planet formation and initial differentiation are good examples of this. Other processes such as volcanism, metamorphism, and weathering continued over different periods of time on different bodies.

Billions of years ago, the elements which would eventually make up our solar system were produced in other stars. Around 4.6 billion years ago a rotating disk of gas and dust called the nebula formed from these elements. The center of the nebula collapsed under gravity to form the Sun. Slightly later, about 4.55 billion years ago, continued condensation and accretion led to the formation of the planets, moons and asteroids of the solar system. Very soon after their formation the inner planets, Moon and some of the larger asteroids melted and differentiated to produce core-mantle-crust. Basaltic volcanism, metamorphism and weathering took place shortly after the surfaces of these bodies formed. Thereafter the asteroids were geologically inactive except for impacts and the evidence of their early history was preserved.

The Moon and inner planets continued to evolve geologically for various periods of time which appear to depend on the size of the body. The record of their earliest geologic history is obscured by this subsequent activity. The oldest Moon rocks, anorthosites, norites and troctolites, date the initial differentiation and first magmas production at 4.4-4.5 and 4.2-4.5 billion years, respectively. The lunar cataclysmic bombardment (discussed in the companion volume *Exploring the Moon*) occurred about 3.9 billion years ago. Mare basaltic volcanism began before 4 billion years and continued until around 2-3 billion years. Geologic activity (other than impact) on the Moon ended long ago.

Our knowledge of the geologic histories of Mars and Venus is extremely limited. The Viking mission to Mars revealed ancient highlands, giant “young” volcanoes, and extensive surface weathering. The samples analyzed by the Viking lander were weathered rocks and soils. The martian meteorites are all igneous rocks most of which have ages of 180 million years (My) to 1.3 billion years. Thus martian basaltic volcanism continued at least to 180 My ago. One martian meteorite is an ancient rock 4.5 billion years old. The Magellan mission remote observations suggest that there may still be active volcanoes on Venus today. We have only very limited analyses of surface samples and no known meteorites from Venus so our information about the geologic history of Venus is woefully inadequate.

Earth is clearly the planet about which we have the most information. However, Earth’s current geologic processes (plate tectonics, volcanism, metamorphism and weathering) have hidden the early history by changing the surface rocks. The earliest known Earth rocks are about 4.0 billion years old, although geologists think that Earth history began at 4.5 billion years along with the Moon and asteroids. Earth is clearly still geologically active today.

Earth is the only body in the solar system where we know for certain that life began and evolved. The conditions necessary for life as we know it (water, carbon, nitrogen and moderate temperature) are not currently available on any other body; however, there is evidence that Mars was wetter and may have been



Martian meteorite ALH84001. This 4.5 billion year old rock may contain fossil evidence that primitive life may have existed on Mars as much as 3.6 billion years ago.

warmer in the past. The ancient martian meteorite may contain evidence of fossil life from an earlier era. The debate about life in the martian meteorite continues and may not be resolved without martian returned samples. The earliest evidence of life on Earth is dated around 3.7 billion years ago. Life evolved through ups and downs to the present. Periodic mass extinctions changed the direction of evolution. For example, at 65 million years ago 75% of all species died and small mammals took over dominance from the giant reptiles called dinosaurs. Whether the cause of these mass extinctions is a biologic process or the geologic process of meteorite impact is still hotly debated. Nevertheless, meteorite impacts, both small and medium-sized, continue on Earth and other planets at the present.

The history of our solar system is long and complex. Our knowledge has been gained through various studies in geology and astronomy and related fields. Scientists are still trying to understand the physical and chemical processes in solar system history so the story is not complete. However, the history as we see it involves similar processes occurring at varied times on different bodies. Taken as a whole, it is a fascinating story.

Future Exploration

Further understanding of the history of the solar system is closely linked to the future exploration of space by robotic and human missions. There is still much that we can learn about solar system processes from studies of meteorites and Apollo lunar samples and from telescopic studies of the planets. But think how much more we can learn about planetary bodies with new samples and close-up geologic exploration! The six Apollo lunar landings demonstrated the value of human observation and ingenuity in exploration and returned many documented samples for continued studies. The spectacular results of the Voyager and Viking missions showed how much we can learn about distant planets from robotic missions. Future missions such as the Mars Surveyor orbiter and lander series and the Discovery class missions to the Moon (Prospector), an asteroid (NEAR) and a comet (Stardust) promise exciting discoveries in the next ten years.

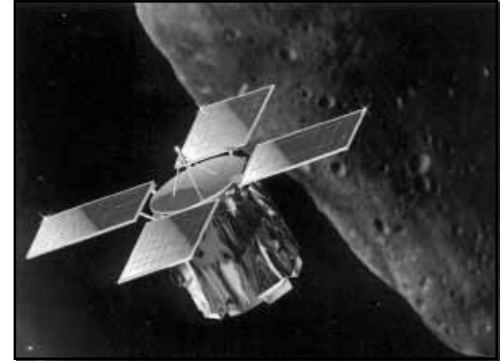

Near Earth Asteroid Rendezvous (NEAR) spacecraft. The NEAR mission will rendezvous with Asteroid 433 Eros in February 1999.

Exploration of space has other benefits besides knowledge. It creates new technologies and, perhaps more importantly, it inspires people to excel and to work together. However, space exploration, especially human exploration, is a very expensive business. Not only must the benefits of knowledge, technology, inspiration, and cooperation be high, but the costs must be reduced as much as possible. One of the most effective means of reducing costs comes from using space resources and reusing everything possible.

Asteroidal Resources

NASA has worked on a number of plans for future robotic exploration of the planets, asteroids, and comets and on human missions to the Moon and Mars. The most important expendables for space exploration are energy for transportation and operations and consumables for life support. It takes lots of expensive energy to move a mass of consumables against Earth's gravity. It takes much less energy to move the same mass in lower gravity environments like the Moon and especially asteroids. There is a big advantage in energy, and

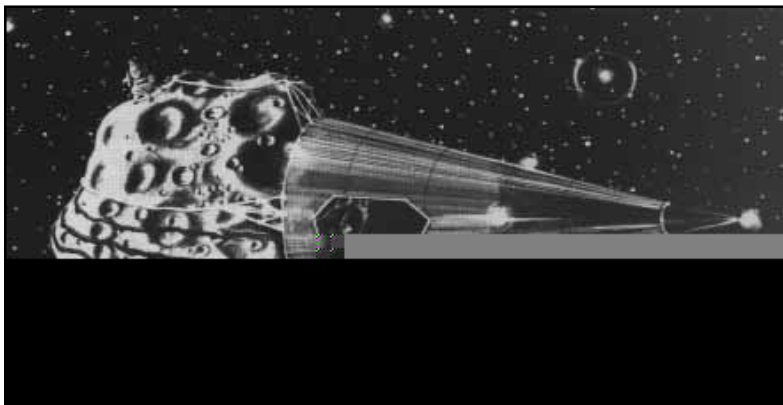

Mining an Asteroid. This is an artist's idea of mining an asteroid to support space exploration. Depending on the type of asteroid, the products might be oxygen, metal, glass, water, organic compounds or several of these resources at once. (Credit: Dennis Davidson)

thereby cost, in using space resources as compared to carrying them from Earth. It may even be advantageous to get resources from one place in space for use in other places.

The closest planetary targets, the Moon, Mars, and asteroids, have little or no atmosphere and surface water, and no known plants for food, but there is abundant energy for operations from solar radiation. Moreover, the rocks and soils can provide many of the elements necessary for space exploration. The rocks themselves are nearly half oxygen, and some also contain water and organic compounds. NASA has developed technologies to extract oxygen from rocks, producing metals or glass as by-products. This oxygen will be used mostly for spacecraft propulsion, but also for astronaut life support. The metals and glass, as well as surface rocks and soil, can be used for building materials and radiation shielding. NASA has also developed methods of growing plants in closed environments, reusing scarce consumables.

The first targets for extended space exploration and resource utilization are likely to be the Moon and asteroids. The Moon is close and relatively easy to get to. Although it doesn't have air, water, or food, we know what it is like, and we could produce oxygen, water, and even food in lunar factories and greenhouses. Ideas for a Moon base are discussed in the companion volume *Exploring the Moon*. Asteroids are such small bodies that their minimal gravity makes it easy to get materials off the surface and into space. In fact it takes less energy to get materials to and from some near-Earth asteroids than from the Moon. The Moon and asteroids could provide test-beds for proving technology to sustain life on Mars or extended space flight.

Asteroids are particularly promising for using space resources because they offer a variety of different resources. Asteroids similar to stony meteorites could provide oxygen for fuel and metal or glass for construction. Asteroids similar to iron meteorites could provide metal, even some precious metals, with very little processing. Perhaps most promising, asteroids similar to carbonaceous chondrites could provide water and organic compounds essential for life support. Mining asteroid resources could become a stepping stone to human exploration of the outer solar system. (See Lesson 17)

Mars Exploration

Mars is the ultimate near-term goal for human space exploration. It is the closest planet that may be habitable by people. Venus, although closer to Earth, has a highly toxic atmosphere

Future mission to Mars. In the year 2020 Mars exploration will be returning samples from the red planet. (Credit: Pat Rawlings)





Exploring Mars. This painting shows astronauts exploring Mars using a rover for transportation. The astronauts are at the top cliff of a large canyon which is shrouded in mist. (Credit: Pat Rawlings)

and extremely high temperatures which make it uninhabitable. Mars has a less toxic atmosphere and moderate temperatures. Mars has always intrigued people because some astronomers thought they saw channels suggesting the possibility of intelligent life. Recent geologic studies have shown that all surface features are natural formations, but also confirmed that Mars is the only other planet in our solar system that could once have harbored life of some kind. Although the Viking landers did not detect life in the martian soil, we can't be certain that life doesn't or did not exist elsewhere on the planet. Mars is now cold and dry, but it was not always so. There is evidence that water flowed on the surface in the past. Mars was once wetter and may have been warmer, and more hospitable for life. Several martian meteorites show interaction with martian water. The oldest one, ALH84001, may even have evidence of past life on Mars. The possibility of life and the more habitable conditions make Mars an important target for exploration.

Most of our information about Mars was collected during the Mariner and Viking missions. They were flybys and orbiters that photographed the planet and made geophysical and geochemical measurements, and landers that analyzed the atmosphere and soil composition. Mars' weather is always changing. Wind and dust storms are common and sometimes global. The polar ice caps change with seasonal temperature changes. Major changes occurred some time in the past which made the surface water disappear and the atmosphere decrease. We do not yet understand the causes of these changes.

Mars' geology is also fascinating. Although the planet is much smaller than Earth, the scale of its major geologic features is much larger. Mars' volcanoes are the largest in the solar system, ten times greater than the largest on Earth. Mars' huge canyon, Valles Marineris, is as long as North America is wide! Mars is divided by a global cliff into old cratered southern highlands and young volcanic northern plains. Both the highlands and the plains have been eroded by water and wind. The two Viking landing sites in the plains had soil compositions similar to basalts altered by water. The martian meteorites are all igneous rocks, mostly from the young northern plains, but they contain some minor minerals in cracks and bubbles that are products of alteration by water. There are many questions left unanswered about the geology and climate

of Mars. How has the planet changed with time? Why are the northern and southern hemispheres so different? What caused the climate to change drastically so that the surface water and atmosphere disappeared? Is water or ice present at the poles or as permafrost? Is there convincing evidence of life, either living organisms or fossils? These are some of the questions to be addressed by future exploration.

The exploration of Mars is a complicated and expensive endeavor. The trip to Mars takes at least six months when the two planets are closest, which happens every two years. Ideally, Mars exploration will include a combination of robotic and human missions. Robotic exploration is necessary in the early stages to conduct global surveys and investigate potential sites for human exploration. Robotic missions will also test technologies, deliver cargo, and return the first documented Mars samples. Human missions are desirable for detailed exploration of selected sites because people are best at observation, interpretation and problem solving.

Preparation for a human mission to Mars is extensive. The mission would last about three years, including the long trip each way and plenty of time for exploration while waiting for the planets to return to closest approach. This extended mission requires a huge amount of consumables, both for fuel and for life support. The amounts can be reduced to about one third by using Mars' resources. The selected site should be one where water or ice is available for human use. NASA is developing technologies to produce oxygen from the carbon dioxide in Mars' atmosphere. This would be used for breathing, but also to power rovers for exploration and the spacecraft for the return trip to Earth. Astronauts could grow plants for food in greenhouses that recycle CO₂ and other waste components. With habitats for shelter and rovers for transportation, the first Mars outpost could be nearly self-sufficient. It would also be the first step in a permanent human presence on Mars.

Once their basic needs are met the astronauts will spend part of their time on exploration and sample analysis. They will observe geologic formations, collect rocks and soils, and look for any signs of life. In the habitat labs they will do geochemical and biological analyses. Together with their scientific colleagues back on Earth they will attempt to answer some of the questions about the evolution of Mars and its part in the history of the solar system. By exploring the asteroids and planets we may be able to solve some of the mysteries revealed by meteorites.

Mars Habitats. *The joined habitats provide the crew with multiple pressurized volumes for conducting greenhouse experiments, biological research, geochemical analysis of samples, and general crew accommodations. (Credit: Jack Frassanito)*



Major Minerals in Meteorites

Listed are the major minerals in meteorites, their composition and occurrence. Minerals are listed by group: silicates, metal, sulfides, oxides, phosphates, and carbon compounds. Many other minerals occur in small abundances but are not listed. Mineral compositions in meteorites and other rocks are variable, with similar elements substituting for each other in the crystal structure (for example Mg, Fe, Ca in silicates or Mg, Fe, Cr, Al in oxides). Variations in these mineral compositions are important in meteorite classification.

Mineral	Formula or Composition	Occurrence in Meteorites
Silicates olivine pyroxene feldspar clay minerals	(Mg,Fe)Si ₂ O ₄ (Mg,Fe,Ca)SiO ₃ CaAl ₂ Si ₂ O ₈ .NaAlSi ₃ O ₈ (Mg,Fe,Ca) ₃₋₆ Si ₄ O ₁₀ (OH) ₂ *H ₂ O	stony and stony-irons chondrites, stony-irons chondrites, achondrites, stony-irons most abundant in achondrites mostly in carbonaceous chondrites
Metal kamacite, taenite	Fe (low and high Ni)	abundant in irons, stony irons common in most chondrites
Sulfides troilite, pyrrhotite	FeS, Fe ₇ S ₈	abundant in irons, stony irons minor in stony meteorites
Oxides spinel, magnetite, chromite	(Mg,Fe,Cr,Al) ₃ O ₄	minor in most meteorites composition depends on type
Phosphates apatite, whitlockite	Ca ₅ (F,Cl,OH)(PO ₄) ₃ , Ca ₂ PO ₄	minor in stony meteorites
Carbon compounds diamond, graphite organic molecules, amino acids	C (elemental carbon) C,H,O,N compounds	carbonaceous chondrites carbonaceous chondrites

Meteorite Classifications

Listed are the major types and classes of meteorites, with examples of each. Major types are in **bold** and most abundant classes are in *italics*. Minor classes are in normal font and only those discussed in text are listed. Other sometimes more abundant classes are omitted for simplicity.

Type / Class	Mineralogy / Rock Types	Examples
Stony - chondrites <i>ordinary chondrites</i> carbonaceous chondrites	silicate minerals, chondrules varied iron, metamorphism varied metamorphism, weathering	Noblesville, LEW87030, ALH90411 Allende, ALH83100
Stony - achondrites <i>basaltic achondrites</i> planetary- lunar - martian	silicate minerals, no chondrules basalt, breccia, pyroxene cumulate basalt, anorthosite, breccia basalt, pyroxene-olivine cumulate	Juvinas, Johnstown, EET83227 ALHA81005, EET87521 EETA79001, Shergotty
Stony-irons	metal-silicate cumulate, breccia	Brenham, Estherville
Irons	iron-nickel metal intergrowths	Sikhote Alin, Gibeon

Meteorites in Meteorite Sample Disk

Name	Location	Find date	mass (kg)	classification
ALH90411	Allan Hills, Antarctica	1990	5.8	chondrite L3
LEW87030	Lewis Cliff, Antarctica	1987	8.0	chondrite H5
Allende	Allende, Mexico	1969	1,000	carbonaceous chondrite
EET83227	Elephant Moraine, Ant.	1983	2.0	basaltic achondrite
Gibeon	Namibia, Africa	1836	21,000	Iron - octahedrite
Brenham	Kansas, USA	1882	4400	Stony-iron - pallasite

Descriptions of Meteorites in Meteorite Sample Disk

ALH90411 (Chondrite A) This ordinary chondrite has numerous clasts and chondrules in a light gray matrix. It is a low-iron, non-metamorphic chondrite made up mostly of olivine and pyroxene silicate minerals, with a little iron-nickel metal.

LEW87030 (Chondrite B) This ordinary chondrite has abundant metal and few clasts or chondrules in a dark gray matrix. It is a high-iron, metamorphic chondrite made up of olivine and pyroxene silicate minerals and iron-nickel metal.

Allende (Carbonaceous Chondrite) This carbonaceous chondrite is a dull black sample with visible clasts and chondrules in hand specimen. A thin slice shows numerous small white inclusions and chondrules in a dark carbonaceous matrix.

EET83227 (Achondrite) This basaltic achondrite is a rock made up of fragments of various types of basaltic materials in a fine-grained matrix. A thin slice shows fragments of different types of pyroxene-feldspar basalts and mineral fragments in a matrix of the same minerals.

Gibeon (Iron) This iron meteorite has a fine-grained intergrown of kamacite and taenite iron-nickel minerals. This criss-crossed intergrowth is called Widmanstätten texture and is visible on the sawn surface that has been etched with acid.

Brenham (Stony-iron) This stony-iron meteorite is a cumulate consisting of yellow olivine silicate crystals surrounded by iron-nickel metal. The metal has been polished and would show a Widmanstätten texture if it were etched with acid.

We would like to thank the following organizations for providing meteorite samples for the disks:

U.S. Antarctic Meteorite Program (NSF), for ALH90411, EET83227, and LEW87030
 National Museum of Natural History, Smithsonian Institution, for Allende and Gibeon
 Field Museum of Natural History, for Brenham

Exploring Meteorite Mysteries

Solar System ABC's Fact Sheet

Bodies in the Solar System

Listed are the Sun and bodies in the solar system that may be sources of meteorites. These include major bodies (planets) and minor bodies (Moon, asteroids and comets). Given are the body name, diameter, orbit, and surface and atmosphere composition. Orbital data include distance from the Sun (AU, semi-major axis), and eccentricity (e: 0 for circular, 1.0 for parabolic, and values between are elliptical).

Body	Diameter km	Orbit AU	Orbit e	Surface Composition	Atmosphere Composition
Sun	1,400,000	--	--	none	H ₂ , He, C, N
Mercury	4,880	0.4	0.20	silicates	none
Venus	12,100	0.7	0.01	silicates	thick CO ₂
Earth	12,800	1.0	0.02	silicates, H ₂ O	medium N ₂ , O ₂ , H ₂ O
Moon	3,480	1.0		silicates	none
Mars	6,800	1.5	0.09	silicates, H ₂ O, CO ₂ ices	thin CO ₂
Asteroids	<1,000	2.2-3.8	vary	silicates, iron	none
Jupiter	143,200	5.2	0.05	liquid H, silicate core	thick H ₂ , He
Saturn	120,000	9.5	0.06	liquid H, silicate core	thick H ₂ , He
Uranus	51,800	19.2	0.05	liquid H, silicate core	thick H ₂ , He, methane
Neptune	49,500	30.0	0.01	liquid H, silicate core	thick H ₂ , He, methane
Pluto	2,300	39.4	0.25	silicates	very thin methane
Comets	1-10	per: 4-7 40,000	0.4-0.9 1.0	H ₂ O, ices of methane, ammonia, silicates	H ₂ O, H,C,O,N compounds

Asteroids

Twenty asteroids are listed in order of distance from the Sun. Given are the asteroid number and name, year discovered, diameter, semi-major axis of orbit, and asteroid type. The first four asteroids are Earth or Mars-crossing and have elliptical orbits. The next 13 asteroids are all in the asteroid belt and have nearly circular orbits. These were chosen to include the largest of the common S and C type asteroids and examples of the rarer types U, E, M. The last three asteroids have orbits outside the asteroid belt. Hector is within the orbit of Jupiter.

Number	Name	Year	Size km	Orbit AU	Type
2062	Aten	1976	0.9	0.97	S
433	Eros	1898	23	1.46	S
1862	Apollo	932	1.4	1.47	U
1221	Amor	1932	1.0	1.92	S
4	Vesta	1807	549	2.36	U
7	Iris	1847	210	2.39	S
44	Nysa	1857	73	2.42	E
6	Hebe	1847	201	2.43	S
21	Lutetia	1852	115	2.43	M
19	Fortuna	1852	215	2.44	C
3	Juno	1804	265	2.67	S
1	Ceres	1801	940	2.77	C
2	Pallas	1802	540	2.77	C
45	Eugenia	1857	228	2.72	C
16	Psyche	1852	265	2.92	M
10	Hygeia	1849	410	3.14	C
65	Cybele	1861	280	3.43	C
279	Thule	1888	60	4.26	D
624	Hector	1907	150x300	5.15	D
944	Hildago	1920	39	5.80	D

Comets and Meteor Showers

Listed are ten periodic meteor showers, their dates of peak annual activity, and the comet associated with each shower. Meteors are produced when the Earth passes through the orbit of the comet and its residual gas and dust particles burn up in the atmosphere.

Comet	Shower	Date
1491I	Quadrantids	January 3
Thatcher	Lyrids	April 23
Halley	Aquarids	May 4
Encke	Taurids	June 30
Swift-Tuttle	Perseids	August 12
Giacobini-Zinner	Draconids	October 9
Halley	Orionids	October 21
Encke	Taurids	November 4
Temple	Leonids	November 16
Phaeton	Geminids	December 13

Evidence for Processes in the Solar System

Listed is the geologic evidence for rock-forming processes on various bodies in the solar system. Many of the processes occurred on all planetary bodies and some asteroids. However, the geologic evidence is not always available because it is masked by later processes.

Process	Earth	Moon / Mars	Asteroids (meteorites)
condensation	no evidence	no evidence	carbonaceous chondrites
accretion	no evidence	no evidence	chondrites
differentiation	core/mantle/crust	anorthosites, meteorites	irons, stony-irons
volcanism	basalts, volcanoes	mare basalts, meteorites	basaltic achondrites
metamorphism	metamorphic rocks	lunar metamorphic rocks	chondrites
weathering	sedimentary rocks	Mars geology, meteorites	carbonaceous chondrites
impact	meteorite falls, craters	breccias, craters	meteorites, breccias

Solar System Timeline

Listed are major events or processes in the history of the solar system as determined from the geologic or astronomical evidence. Time is in years (y) before the present (K=thousand; M=million; B=billion). Some of the events on the Moon are not discussed in this book, but are explained in the companion volume *Exploring the Moon*.

Time	Where	Event or Process	Evidence
0 y - 4.0 By	Earth	volcanism, metamorphism, weathering	Earth rocks, geology
3, 25, 47 y	Earth	falls-Noblesville, Allende, Sikhote-Alin	meteorites
50 Ky	Earth	fall of Canyon Diablo, Meteor Crater	crater, meteorite
0.1-11 My	Moon	impacts sent lunar meteorites to Earth	lunar meteorites
0.5-16 My	Mars	impacts sent Mars meteorites to Earth	Mars meteorites
65 My	Earth	K/T impact and death of dinosaurs	Ir in soils, fossils
0.2-4.5 By	Mars	basaltic volcanism, intrusions	Mars meteorites
3.2-4.3 By	Moon	mare basaltic volcanism	lunar basalts, meteorites
3.7 By	Earth	first evidence of life on Earth	fossils
3.9 By	Moon	cataclysmic bombardment	breccias, craters
4.0 By	Earth	oldest known Earth rock	Earth rocks
4.2-4.4 By	Moon	igneous intrusions	troctolite, norite
4.2-4.55 By	Asteroids	metamorphism, weathering	chondrites
4.4-4.5 By	Moon	differentiation, magma ocean	anorthosites, meteorites
4.55 By	Asteroids	differentiation, core, mantle, crust	achondrite, iron, stony-iron
4.55 By	nebula	solar system forms by condensation, accretion	chondrites, astronomy
4.6 By	nebula	Sun forms from nebula	astronomy, physics
>4.6 By	Stars	elements form in other stars	astronomy, physics
~10 By	Universe	H, He formed by "Big Bang"	astronomy, physics

Exploring Meteorite Mysteries

Lesson 1 — Noblesville Fall

Mysterious Meteorites

Objectives

Students will:

- participate in a brainstorm session that will help focus their interest on and arouse their curiosity about meteorites.
- view a slide show that provides background information.

Background

Throughout the world meteorite falls are rare events that are observed just a few times a year. The fall of the Noblesville meteorite in 1991 was observed by two boys. The story of the boys and the meteorite makes an excellent focus for the unit.

Procedure

Advanced Preparation

1. Review story and be ready to tell it like a storyteller.
2. Preview slide set and narrative.



About This Lesson

Students will listen to the story of an actual meteorite fall and brainstorm on what they want to know and how they would react. The questions students generate will relate directly to the units contained in *Exploring Meteorite Mysteries* and will help teachers focus students' attention on meteorite investigations. After making a list of what they want to know, they will view a slide show introduction to meteorites.

Materials

- Noblesville Fall Narrative (pg. 1.2)
- Slide Set, Introduction
- projector
- screen
- chalkboard or overhead projector

Vocabulary

meteorite, fall, find, crater

Photo of boys courtesy of M. Lipshutz.

Classroom Procedure

1. Tell the Noblesville Fall Narrative, Part 1 with as much animation and sound effects as possible.
2. Ask the class to put themselves in the boys' place and tell how they would feel, what they would want to know, and what they would do next? Brainstorm on these questions, making a random list of responses on the board. The class could then organize the responses into groups such as Feelings, Actions, and Questions. Some of the questions students may express are: What is it? Where did it come from? How did it get here? What is it made of? How did it form? What good is it? Is it dangerous?
3. Conclude the Noblesville Fall Narrative, Part 2 about what the boys did.
4. Show slides as an introduction to meteorites.



Noblesville Meteorite

Noblesville Fall Narrative

**Part 1: Observation
of the fall**

It was 7:00 PM and early dusk on the summer evening of August 31, 1991, in the small town of Noblesville, Indiana. Two boys, 13 year old Brodie Spaulding and 9 year old Brian Kinzie, had just finished riding bikes and were standing talking on Brodie's lawn. Suddenly they heard a low-pitched whistling sound. Then Brian saw an object spinning through the air past Brodie. The object landed with a thud on the ground 4 meters from them and rocked as it landed. The boys picked up the object, which appeared to be a stone, and found that it was slightly warm. It had made a hole 5 centimeters deep in the lawn where it landed. They looked around and couldn't find anyone who might have thrown the stone.

Stop for class brainstorm session.

Part 2: What the boys did

What Brodie and Brian did was take the stone inside to Brodie's parents. They decided to call nearby Purdue University. The mystery was solved a few days later when a Purdue professor confirmed that the rock was a meteorite. The boys let the scientists have a small portion of the meteorite for scientific studies. Today, although meteorite dealers have offered them several thousand dollars to buy the meteorite, the boys still own it.

The boys learned that meteorites are very special rocks that have fallen to Earth after traveling through the solar system. They provide clues for scientific detectives to solve the mysteries of our early solar system, the origin of the planets, and the beginning of life itself.

Exploring Meteorite Mysteries

Lesson 2 — Follow the Falling Meteorite

Objectives

Students will:

- apply geometric properties and relationships to meteorite hunting.
- demonstrate and experience the way remote objects or sites can be accurately located by triangulation.
- use triangulation on a map, both in a directed activity and in a group-challenge activity.

Background

Triangulation is a basic geometric technique for locating distant objects or events by measuring the directions to an object from two known locations. The basic premise behind triangulation is that many of our senses can accurately determine the direction to an object but cannot always accurately determine its distance.

However, two observers in different locations will see the object in different directions. The two known locations of the observers form the base of a triangle. The angles to the distant object define where that object is located, as seen in Figure 2-1.

Triangulation is used extensively in astronomy to determine distances or sizes of objects we cannot visit (like stars and planets). Triangulation is a useful map and survival skill often taught in scouting and orienteering. This technique is used in surveying and in determining the epicenter of an earthquake. It is also a good introduction to the geometry and mathematics of triangles.



*“Where
do they
come
from?”*

About This Lesson

In the activities in this lesson students use sound to easily demonstrate basic triangulation techniques. They also triangulate using a meteor’s path to predict where meteorites might be found. Extended math applications may be added. Students also develop a treasure hunt map in the final activity.

Vocabulary

meteor, meteorite,
triangulation

Lesson 2 — Follow the Falling Meteorite

Activity A: Demonstration of Triangulation

About This Activity

Students will demonstrate how to locate distant objects or sites by triangulation. They will use sound to show the basic principles of triangulation. This activity can be done indoors or outside.

Materials for Activity A

- blindfolds for two
(optional)
- noise maker (*anything that makes a noise*)
- yarn (*enough to “trace” the triangle in Activity A-Step 2, or ~50 m*)

Procedure

Advanced Preparation

1. Gather materials.

Classroom Procedure

1. Choose a student to be the listener (not hearing-impaired in either ear), and another to make noise (bell, buzzer, pencil tapping etc.). Make sure that the listener cannot (or will not) see during the procedure, as by blindfolding. Have the noise maker go to a far point in the room, moving quietly or masked by noises made by the other students. When the room is quiet again, have the noise maker make a sound. Repeat if necessary until the listener points at the noise maker. Almost all students will be able to point very close to the direction of the noise maker. [Many students have probably played the swimming pool game “Marco Polo,” which is this same idea.] Ask blindfolded listener to determine distance to the noise maker. Show the students that a single listener can tell the direction to the noise, but not always the accurate distance.
2. Chose two students to be listeners and repeat as in step 1, keeping as much distance between them as possible. Both listeners should be pointing fairly close to the noise maker. Show how the location accuracy is improved. To make it easier for students to see the triangle, try using yarn to trace the visual lines of sight.
3. Repeat with more than two listeners if desired. A small “target area” will usually be formed.

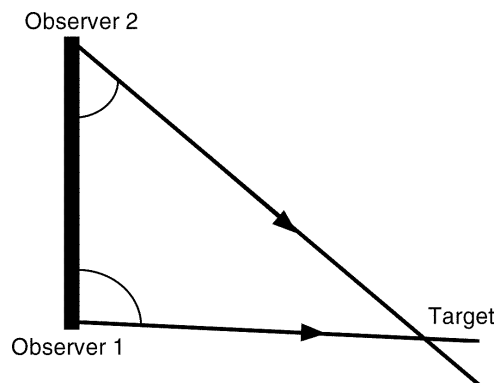

Figure 2-1

Lesson 2 — Follow the Falling Meteorite

Activity B: Path and Speed of a Meteor

Procedure

Advanced Preparation

1. Review student procedure.
2. Assemble materials.

Classroom Procedure

1. Review use of protractors, map coordinates, map scale and units.
2. Practice several protractor readings (see example below).
3. Distribute “Student Procedure: Activity B.”
4. If desired, work the first observation measurement as a class or on the overhead.
5. Allow students to continue working on the worksheet.
6. Discuss.

Map Teacher Key

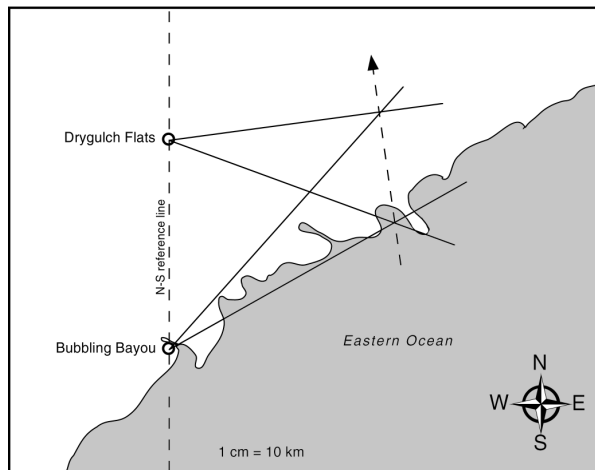

Question Key

Section 1

Where do the two lines cross?

40-43 km East-Northeast of Drygulch Flats.

Where did the meteor explode?

In the air near where the lines crossed, or same answer as first question.

Section 2

Where was the meteor when the spark flew?

50-52 km northeast of Bubbling Bayou, or near the coastline by the peninsula.

About This Activity

Students will track a meteor’s path using triangulation and predict where its meteorites might be found. The exercise can be extended to calculating the velocity of a meteor and understanding how scientists can determine a meteor’s original orbit in space.

Materials for Activity B

- protractors
- rulers
- Student Procedure
(pgs. 2.5-2.6, one per student)
- colored pencils
- pencils

Example

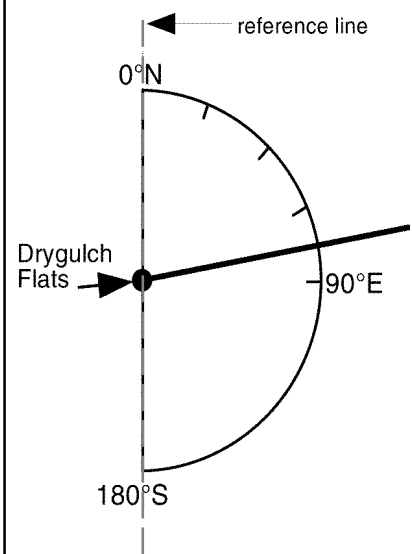

Using the positions of the spark and the explosion, which direction was the meteorite traveling?

North-Northwest

How far was it from where the meteorite sparked to where it exploded?
(measure with ruler)?

23-25 km

Where would you first look for meteorites that might have fallen from the explosion?

Northeast of Drygulch Flats, near where the lines cross.

Section 3 (optional)

If both observers counted two seconds between the spark and the explosion, how fast was the meteor going?

Approximately 43,200 km per hour.

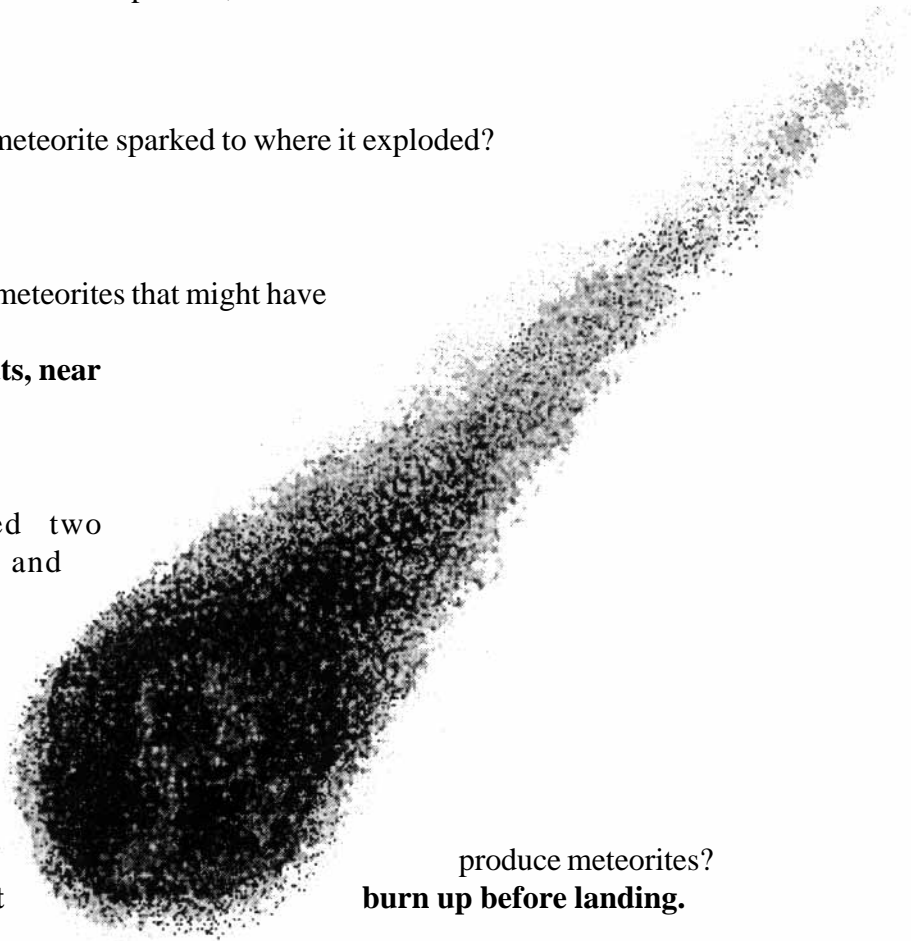

Extra Thinking Questions

1. Why might a meteor not produce meteorites?
The meteorite might burn up before landing.
2. Could a meteorite fall without anyone seeing a meteor? Explain.
Yes. Meteors can be small enough and slow enough that they do not make big meteor streaks in the sky; no one saw a meteor when Noblesville fell. Also, it might fall at a time or remote location where no one is looking.
3. How could you determine the elevations of the meteor's sparking and its explosion?
You can calculate the height using the determined distance and the measured observed angle above the horizon $h = d \tan \text{angle}$.
4. What information would you need to determine the orbit a meteorite was in before it hit the Earth?
You would need several accurately located photo observations of the meteor with exact time records, and data charts of Earth's positions. (See also Lesson 4.)

Extensions

1. Try depicting this activity in 3 dimensions by providing altitude angles. Challenge students to come up with a way of representing the true meteor location.
2. For students with a background in algebra and trigonometry, the location of the meteor spark and explosion in Activity B can be determined mathematically using the cosine rule.
3. If possible have students observe and or photograph a meteor shower.

Lesson 2 — Follow the Falling Meteorite
Student Procedure: Activity B

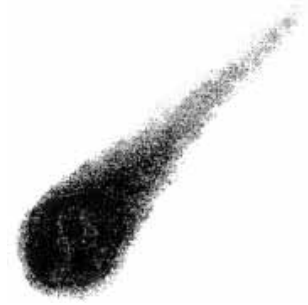

Materials

- ruler
- protractor
- pencil
- colored pencils

Path and Speed of a Meteor

Using the map provided, you will be led through the procedures of triangulating the path and explosion of a meteor and determining a likely area to look for meteorites. Review the use of a protractor if necessary.

Section 1. The attached map shows the location of two people when they saw the meteor. The observer in Drygulch Flats was looking 80° East of North when she saw the meteor explode.

— *From Drygulch Flats, measure an angle 80° E from the dashed N-S reference line, mark the angle, and with a colored pencil draw a long line from Drygulch Flats through the mark you made.*

The observer in Bubbling Bayou was looking in a direction 40° East of North when he saw the meteor explode.

— *From Bubbling Bayou measure an angle 40° E from the dashed N-S reference line, mark the angle. Using the same color pencils draw a long line from Bubbling Bayou through the mark you made.*

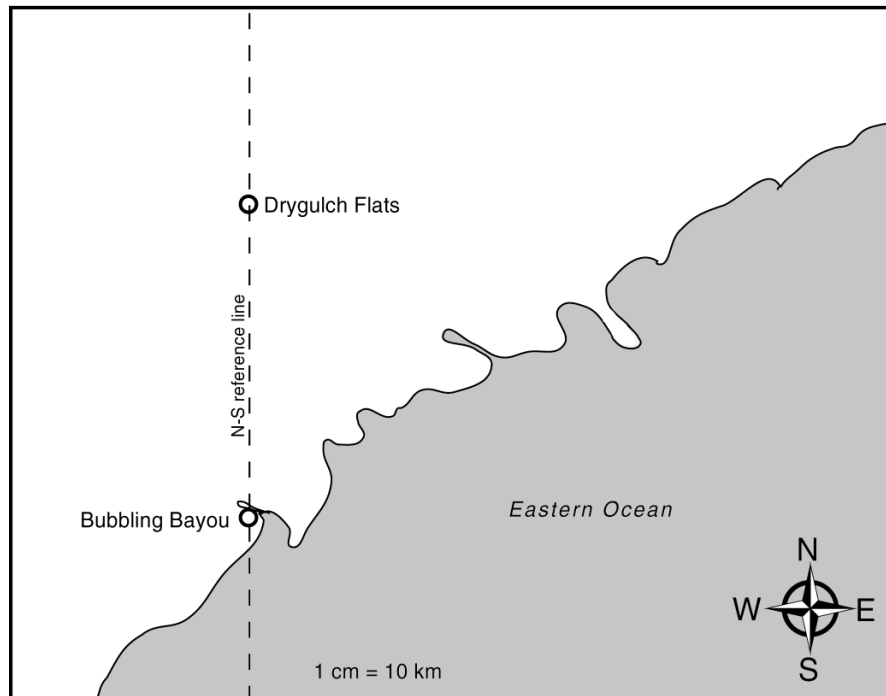

Questions

Where do the two lines cross?

Where did the meteor explode?

Section 2. Both observers also saw the meteor shed a spark some time before it exploded (assume the meteor's path was horizontal). The observer in Drygulch Flats was looking in a direction 110° East of North when she saw the spark fly.

— *Using the same technique as in step 1 and a different color pencil, draw a long line from Drygulch Flats in that direction.*

The observer in Bubbling Bayou was looking in a direction 60° East of North when he saw the spark fly.

— *Draw a long line from Bubbling Bayou in that direction.*

Questions

Where was the meteor when the spark flew?

Using the positions of the spark and the explosion, which direction was the meteorite traveling?

How far was it from where the meteor sparked to where it exploded?
(measure with ruler)

Where would you first look for meteorites that might have fallen from the explosion?

Section 3. Determine how fast the meteor was going. If both observers counted 2 seconds between the spark and the explosion, how fast was the meteor going (in km/hr)?

Lesson 2 — Follow the Falling Meteorite

Activity C: Meteorite Treasure Hunt

Procedure

Advanced Preparation

1. Have copies of local or regional maps for each team.

Classroom Procedure

1. Decide where on the map the two observers would be. Divide the class into teams and give each team two copies of the map.
2. Each team chooses a meteorite fall spot, and marks it with a dot on one map. Determine what direction the observers would have had to look to see the meteorite fall point. Draw lines from the fall point to where each observer is stationed. Measure the angle those lines make with North. At the bottom of the second map or a piece of paper, record these angles for use by another team.
3. Each team passes their list of angles to another team so that they have “look directions” for a new meteorite fall. Then use triangulation as in Activity B to determine where the meteorite fell. This could be done as a race or as an accuracy contest. After teams are finished, they can compare their fall location with the original maps.

Extensions

1. Outside, set up treasure hunt so that students learn to use a magnetic compass.
2. Place a ball bearing in a field to represent a meteorite. Provide a map of the field and triangulation observation angles. Have students attempt to find the “meteorite.”

About This Activity

This triangulation activity can be done as a treasure hunt game using a map of your local community, county, or state. Each team creates directions that allow another team to determine the fall site.

Materials for Activity C

- copies of local or regional map (*two per team*)
- colored pencils
- paper
- protractor (*per team*)

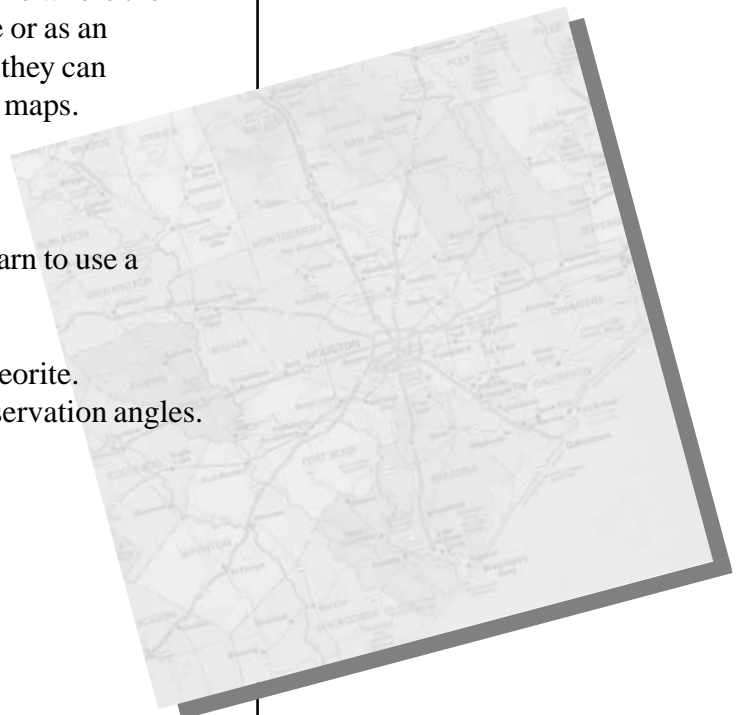

Exploring Meteorite Mysteries Lesson 3 — Searching for Meteorites

Objectives

Students will:

- perform a demonstration of meteorite impacts with water balloons.
- assess various terrains for meteorite recovery using geography skills.
- attempt to recover simulated meteorite fragments.
- make experimental predictions.
- graph experimental results and draw conclusions.

Background

Finding meteorites is quite difficult because most meteorites look like Earth rocks to the casual or untrained eye. Even to the trained eye, recognizing meteorites can be difficult. In many cases meteorites break apart into many fragments as they pass through the atmosphere or impact the Earth. These smaller fragments are harder to find than one large meteorite. Meteorites are rarely found in forests or fields, where they become lost or buried among the plants. In rocky areas, meteorites are hard to find because they tend to be dull black, gray or white, and do not stand out among the much more common Earth rocks (see Meteorite Sample Disk if available). Iron meteorites are the exception. There are few natural sources of metal except meteorites. Old iron implements can be (and often are) mistaken for meteorites. In many cases, a chemical analysis is required to distinguish a meteorite from an Earth rock.

In their experiments, students will likely discover that good places to retrieve meteorites are surfaces that have no similar rocks, are very flat, have a contrasting background, and do not have thick vegetation. These conditions are best met on Earth by the polar ice cap in Antarctica, where in fact, thousands of meteorites have been found since 1969. Lots of meteorites are also found in deserts, especially in the Sahara and in southern Australia, where there are flat areas with few other rocks.

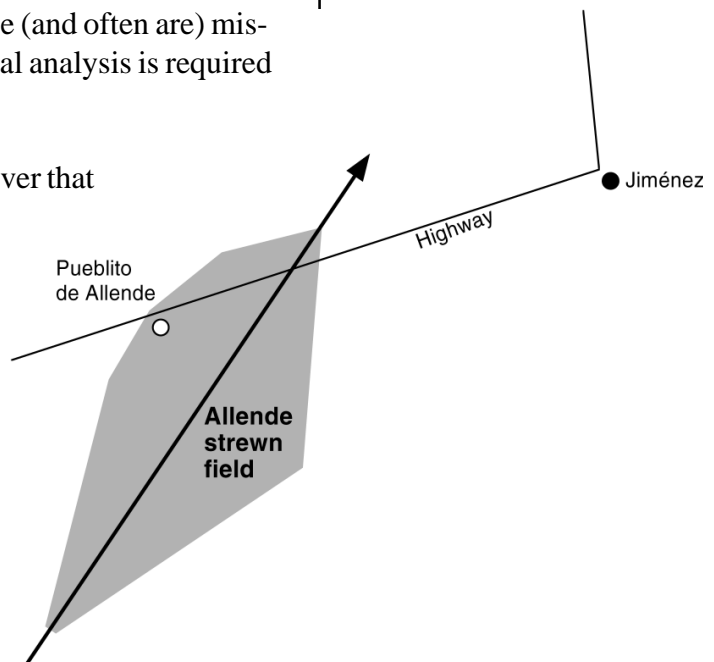

“Where do they come from?”

About This Lesson

Water balloons filled with flour and pebbles help students model the distribution of materials after meteorite impacts. The flour simulates the ejected crater material and the pebbles represent the meteorite fragments. Students will use the model to draw conclusions about where it would be easiest to find meteorites.

Vocabulary

meteorite, ejecta, terrain, velocity, impact

Materials

Per Student

- Student Procedure and Data Table (*pgs. 3.3-3.5*)
- 1 balloon (*round balloons work best*)
- 0.1 liter flour (*1/2 cup*)
- 10 to 20 small pebbles (*colored aquarium rocks work well*)
- graph paper

Per Group or Classroom

- water faucet to fill balloon
- funnel (*one per group*)
- measuring cup
- thin stick or skewer

Procedure

Advanced Preparation

1. Assemble materials.
2. Practice filling balloon with flour and check for appropriate locations to conduct impacts.

Classroom Procedure

1. Distribute Student Procedure and Data Table.
2. Discuss background and intent for activity (why and how).
3. Look at (or discuss) selected impact sites prior to predicting on Student Procedure.
4. Have students collect materials.
5. Follow Student Procedure.
6. Discuss results and lead to conclusions that Antarctica and deserts are likely the easiest places to find meteorites.

Extensions

1. Vary the exercise by using a variety of materials, chart all data, and rewrite the activity, making it more effective.
2. Dramatize the impact and scatter pattern of pebbles, using students as pebbles and doing the dramatization in slow motion.
3. On a world map have students predict where meteorites might easily be found.
4. Lesson 18 could be used to extend the Antarctic meteorite team information.
5. Show Antarctic slides (available from NASA, see page iv).

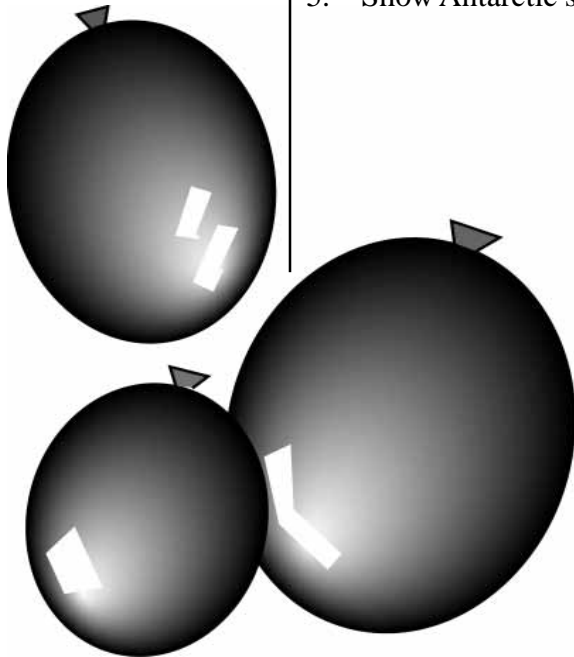

Student Procedure

Materials

Per Student

- Student Procedure and Data Table
- 1 balloon
- 0.1 liter flour (1/2 cup)
- 10 to 20 small pebbles
- graph paper

Per Group or Classroom

- water faucet
- funnel
- measuring cup
- thin stick or skewer

Procedure

Designate Groups

This activity is designed to be done in groups of 3-4 students. Although each student launches (throws) a balloon filled with water and pebbles, students should work as a group to choose areas, make predictions, record observations, and draw conclusions.

Designate Target Areas

Working with your teacher, find 3-4 locations of various surfaces where balloons filled with water and pebbles can be exploded. Surfaces commonly found at a school site are concrete pavement, long jump pit or other sand pit, grassy area, gravel, pebble, or shell surface, asphalt pavement, snow, ice, and water. Be sure to get permission to use all areas.

Classroom Procedure

1. Gather all equipment.
2. Choose or assign terrain targets for each student.
3. Record information on Data Table.
4. Make predictions and record on Data Table.

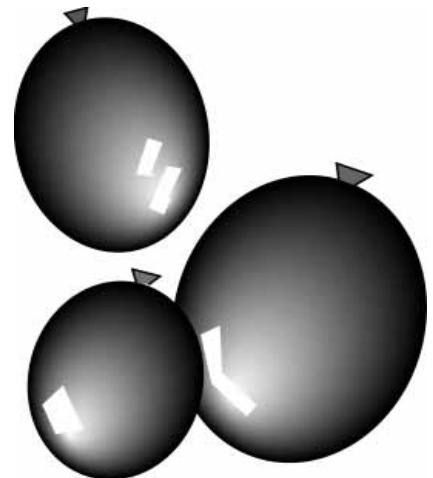

5. Place a funnel in the neck of a balloon. Fill balloon with approximately 0.1 liter (1/2 cup) of flour. Flour tends to pack, so it should be poured into the funnel slowly. A thin stick may be used to keep the flour flowing, but do not puncture the balloon.
6. Add pebbles one at a time, noting number of pebbles and color.
7. Fill balloon 3/4 full with water. **Do not shake the balloon. Be sure to tie the balloon securely.** This step must be done just before going outside to launch the balloons.
8. Launch balloons one at a time in designated areas. You may throw the balloon at an angle, lob them or throw them straight up so that they impact vertically. Remember to work as a group. Record observations at your launch site quickly then move to the next launch. When the group launches are complete, individuals return to their impact site to finish the sketch of their scatter pattern.
9. Clean up all balloon fragments and leave impact areas as clean as possible.

Searching for Meteorites: Data Table

Name: _____ **Other Team members:** _____

Date: _____

Individual Launch Information

Balloon Filling

pebbles (*note number and color*) _____

water volume (*estimate*) _____

flour volume _____

predict number and colors of pebbles
that you will recover _____

Launch Site Description

(*note terrain, estimate wind direction, and wind speed*)

Launch Specifics

impact angle (*estimate*) _____

impact direction _____

impact velocity (*fast-slow*) _____

sketch impact site in the space at right

number(s) and colors of pebbles recovered _____

Team Launch Data

<u>list different terrains below</u> <u>other variables</u> (<i>predict if you think it will be easy or hard to find the pebbles</i>)	<u>pebbles</u> # launched and colors	<u>pebbles</u> # recovered and colors	<u>pebbles</u> % recovered (<i>wind or height, etc.</i>)	<u>explain</u>
example: ice easy	8 ^{2 red, 1 blue,} 5 green	6 ^{2 red, 1 blue,} 3 green	75%	building blocked wind
_____	_____	_____	_____	_____
_____	_____	_____	_____	_____
_____	_____	_____	_____	_____
_____	_____	_____	_____	_____
_____	_____	_____	_____	_____

Graph

Make a graph of the percentage of pebbles recovered from each impact surface. Note how the data compares to your predictions. Include data from different colors of pebbles if available.

Questions

Based on your data, which surface was the easiest for pebble recovery? Why?

Did this match your predictions?

What kind of land surface might be most productive for searching for meteorites? Why?

How is the scatter pattern affected: by the ground surface? by the angle of impact?

How might a scientist use this type of information to help locate meteorites?

Exploring Meteorite Mysteries

Lesson 4 — The Meteorite-Asteroid Connection: Orbits in the Inner Solar System

“Where do they come from?”

Objectives

In Activity A students will:

- draw circles and ellipses to illustrate basic shapes of orbits in the solar system.
- define an elliptical orbit from three of its points (optional).

In Activity B students will:

- construct a scale model of the inner solar system including: the Sun, the inner planets, the asteroid belt, and the orbits of a few selected asteroids.
- observe relative distances and sizes within the inner solar system.
- plot the paths meteoroids might take in traveling from the asteroid belt to the Earth.
- manipulate models to demonstrate the concept of the ecliptic plane, and discover that some asteroids do not orbit in the ecliptic plane (upper grades).

(For Advanced Students)

In Activity C students will:

- graph the locations of the Earth and a near-Earth asteroid.
- observe from the graph that both time and location in space are important.
- estimate when an asteroid would cross the Earth's orbit.

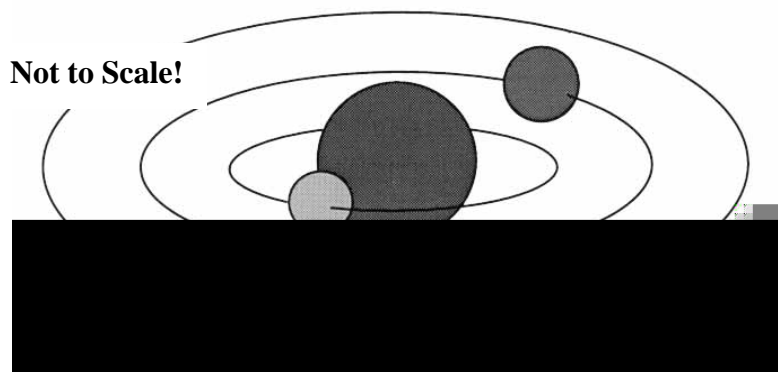

About This Lesson

This lesson allows students to understand how meteorites get from the asteroid belt to Earth and how rare it is for the Earth to be hit by a large asteroid.

The students will build an exact-scale model of the inner solar system; the scale allows the model to fit within a normal classroom and also allows the representation of Earth to be visible without magnification. Students will chart where most asteroids are, compared to the Earth, and see that a few asteroids come close to the Earth.

Students will see that the solar system is mostly empty space unlike the way it appears on most charts and maps.

Higher grade students can extend the activities as a transition to astronomy.

Vocabulary

ellipse, orbit, astronomer, asteroid, asteroid belt, ecliptic plane, retrograde

Background

To appreciate the Earth in respect to meteorites and asteroids in the solar system, it is important to know the configuration of the inner solar system, including the proper relative sizes and distances of objects. Most charts of the solar system show the planets' orbits at a different scale from the planets, so that the solar system appears as large planets close together. The student gets an incorrect impression of how far it is to other planets, how small planets are compared to the distances between them, and how small the Earth is as a target for meteorite impacts. The exact scale model of the inner solar system, from the Sun through the asteroid belt, will allow the student to appreciate the sizes and distances pertinent to these exercises (information in Tables 2 and 4).

Most meteorites are thought to be broken fragments of asteroids — small “planets” or bodies of rock or ice orbiting around the Sun. The largest asteroid is Ceres, 940 km in diameter, much smaller than our Moon (3,500 km diameter). Ceres was the first asteroid discovered (in 1801), and about 6,000 have been discovered since then. Asteroids are so small that telescopes on Earth can see them

only as points of light. Recently the *Galileo* spacecraft passed close to the asteroids Gaspra and Ida and sent us pictures of them. Both are irregular masses of rock, seemingly broken and covered with impact craters. As indicated by their colors (reflectance spectra), most asteroids are mixtures of metal and silicate minerals, possibly like chondrite meteorites. A few are made of basalt rock, just like the basalt meteorites (example: 1983RD in this lesson).

Asteroids Can Have Three Names!

When one is found, it is given a temporary name, like 1983RD, showing what year it was found. After the asteroid's orbit is known well, it gets a number and can be given a 'real' name by the person who found it. The names of the asteroids in this lesson are “1 Ceres,” “1566 Icarus,” and “3551 1983RD.” The last doesn't have a 'real' name yet. Asteroid names come mostly from mythology, but also include famous people, including: “3352 McAuliffe” (after Christa McAuliffe, the teacher/astronaut who was killed when the Space Shuttle *Challenger* exploded), “2266 Tschaikovsky” (after the Russian composer), “1744 Paavo Nurmi” (after a Finnish marathon runner), “1569 Evita” (after Evita Perón, wife of ex-president Juan Perón of Argentina), and “2578 Saint-Exupéry” (after the author of “The Little Prince”).

Most asteroids orbit in the asteroid belt between 2.2 and 3.2 times the Earth's distance from the Sun; their orbits are ellipses, oval-shaped curves that carry them nearer and farther from the Sun. Only a few asteroids follow orbits that get near the Earth, and these asteroids are probably the sources of some meteorites.

An asteroid that crosses the Earth's orbit could collide with the Earth and cause a devastating impact explosion. About 200 of these Earth crossing asteroids are known, and it is estimated that 20-40 percent of them will collide with the Earth over the next million years. No known asteroid will hit the Earth for at least 200 years. We will likely have many years of warning before an asteroid collision like this, and the students will see from the solar system model that the Earth is really a very small target. But when there are a million shots, over a long time, one is likely to hit.

To hunt for asteroids, astronomers photograph the night sky, and look for “stars” that move compared to real stars. A long exposure photograph would show a background of stars as spots, with a streak from an asteroid, due to the asteroid's motion across the sky. To discover the orbit of an asteroid, it is not necessary to observe the asteroid as it follows its whole orbit; knowing its location a few times, over several weeks or months, is sufficient.

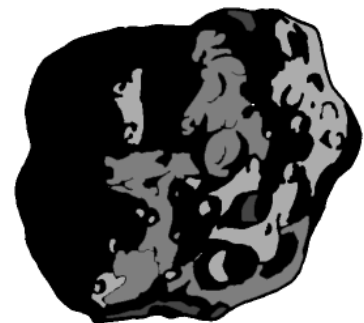

Lesson 4 — The Meteorite-Asteroid Connection

Activity A: Drawing Circles and Ellipses

Objectives

Students will:

- draw circles and ellipses to illustrate basic shapes of orbits in the solar system.
- define an elliptical orbit from three of its points (optional).

Procedures

Advanced Preparation

1. The instructor should prepare a loop of string, approximately 40 cm in circumference, for each group. Additional loops of string of different sizes may be used for experimentation. See figure below.
2. Practice drawing ellipses.

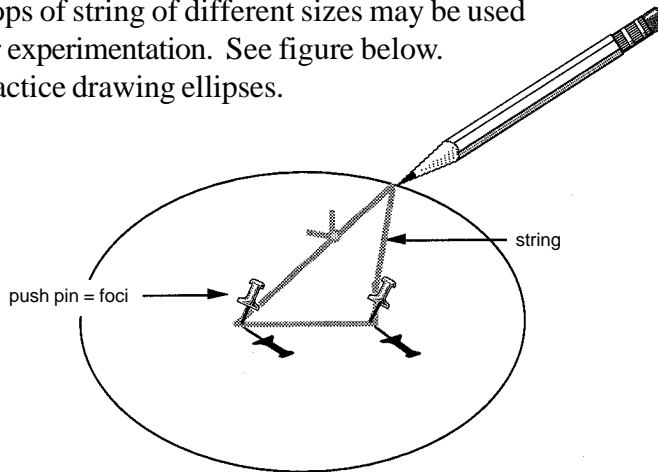

Classroom Procedure

Part 1. Drawing a Circle. Have each group of students stick one pushpin into the center of their cardboard sheet. Put the loop of string around the pushpin, put the point of the pencil within the loop, and draw the loop tight with the pencil tip (not so tight as to pull out the pin!). Draw a line with the pencil, **keeping the string tight**. The pencil line will be a circle around the pushpin.

Part 2. Drawing Ellipses. Have each group of students stick two pushpins into their cardboard sheet near its center, placing the pins 10-15 cm apart. Put the loop of string around **both** pushpins, and carefully draw the loop tight with the pencil tip forming a triangle. Draw with the pencil, keeping the string tight around both pins. The pencil line will be an oval, or **ellipse**. Students may experiment with different distances between pins and different lengths of string. Optional: paper may be taped to the cardboard if desired.

About This Activity

In this activity, students will learn how to draw circles and ellipses using a pencil, pushpins and string. They will learn what an ellipse is, how it is different from a circle, and how an astronomer can determine the elliptical orbit of an asteroid.

Materials for Activity A

- poster board or cardboard, about 60 cm x 60 cm, thick enough to hold a pushpin (*old science fair trifolds work*), one for each group
- tracing paper, about 60 cm x 60 cm, one or more for each group
- pushpins, 6 per group
- pencil/pen
- string
- scissors

Part 3. Find the Asteroid Orbits. The orbits of asteroids are ellipses, not circles, around the Sun. Astronomers can figure out the whole elliptical orbit of an asteroid by knowing just three points in the orbit. In this activity, a team will draw an ellipse, and another team will work like astronomers to try to reconstruct that ellipse knowing only the locations of three points and the “Sun.” **It is important that all the teams have strings of the same length.**

Have each team draw an orbit for an asteroid on their cardboard by drawing an ellipse (Part 2), and designating one pushpin as the “Sun.” Have each team remove the pushpins, place the tracing paper over the orbit drawing, tack the tracing paper to the cardboard at the corners, and using a pen, mark on the tracing paper the “Sun” position and three points on the orbit ellipse (do not draw the entire ellipse). These three “data points” represent observations made by astronomers which are used to plot the orbit of an asteroid. See figures below.

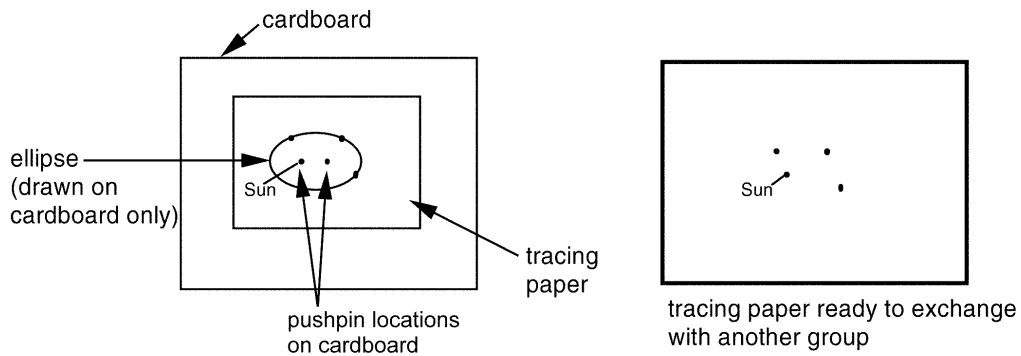

Teams label their ellipses, trade tracing papers, tack their new paper down at the corners, and put a pushpin in at the “Sun” position. Each team of “astronomers” then tries to find a placement for the second pushpin, so that an ellipse drawn with their loop passes through the three points on the tracing paper. When complete, compare with the original group’s ellipse that includes the three data points.

Questions

1. How are ellipses different from circles?
2. What shape is drawn when the pushpins are right next to each other?

Extensions

1. If you wanted to describe an ellipse to another person, what would you say? (length of string, length of ellipse, breadth of ellipse, orientation) What more would you need if the ellipse could be in the air oriented in any way?
2. Part 3 can be extended by having the asteroid orbits drawn with different lengths of string, and having each “astronomer” team determine the string length in addition to the location of the second pin.

Lesson 4 — The Meteorite-Asteroid Connection
**Activity B: The Long and Winding Road
to Earth**

Objectives

Students will:

- construct a scale model of the inner solar system including: the Sun, the inner planets, the asteroid belt, and the orbits of a few selected asteroids.
- construct circular and elliptical planetary orbits.
- conclude that the relative sizes of the Sun and the inner planets are often misrepresented.
- observe relative distances and sizes within the inner solar system.
- plot the paths meteoroids might take in traveling from the asteroid belt to the Earth.
- observe that the Earth is a very small target.
- manipulate models to demonstrate the concept of the ecliptic plane and discover that some asteroids do not orbit in the ecliptic plane (upper grades).

Procedure

Advanced Preparation

1. Gather materials, prepare string loops ahead if desired.
2. Practice procedure.

Classroom Procedure

1. Preparation of the Board.

Mark the center of the large sheet of cardboard; this will be the Sun's location. Draw a circle 1.8-2 mm diameter around the point; this is the scaled diameter of the Sun. If the exact orientations of orbits are desired for upper grades, draw a light reference pencil line from the Sun's center toward a side; angles for orientations of elliptical orbits will be measured from this line.

2. Prepare Strings.

A loop of string is needed for each orbit. The instructor may prepare the loops ahead of time; or student teams may measure, cut, and knot a loop for their own orbit. To keep

About This Activity

In this activity, the class will learn how meteorites and asteroids travel from the asteroid belt to the Earth. The focus here is on construction of an exact scale model of the inner solar system (Sun to asteroid belt), including some asteroids that might hit the Earth. At the given scale (which can be expanded or reduced), the model will fit on a 1.2 m x 1.2 m piece of cardboard or poster board, and the Earth will be just large enough to be seen.

Materials for Activity B

- 1.2 m square or larger piece of corrugated cardboard (*refrigerator box?*) or very stiff posterboard
 - 60 cm x 30 cm piece of corrugated cardboard or very stiff poster board (*upper grades*)
 - pushpins, two per group
 - colored and regular pencils
 - string, or loops of string in the lengths indicated in Table 1
 - scissors, ruler, and protractor
 - clay-dough (*or similar substance*) in yellow or white
 - magazines with colored pictures
 - Table 1 (*pg. 4.6*) and Table 2 (*pg. 4.7*) from this lesson
- Optional for upper grades**
- razor knife or other knife (*to be used only with supervision*)

the proper scale, use the string lengths in Table 1. If the loop turns out too long, it can be shortened with an overhand knot.

3. Draw the Orbits.

Each student team should draw their orbit on the cardboard, using the pin(s) and string technique in Activity A, Part 2 and the data of Table 1; lower grades include the asteroid Icarus here, upper grades may do Icarus separately (See optional section below—Asteroid Icarus in the Third Dimension.).

Circular orbits require one pin at the Sun position. Elliptical orbits require two pins each: one at the Sun and the other at the distance from the Sun shown in Table 1. The ellipses may be oriented at any convenient angle on the board; to make the model exact, the second pins should be oriented at the angles in Table 1 from the pencil line drawn in Part 1 (exact orientations are not used later). See illustration on page 19 in the Teacher’s Guide. To draw the orbit of the Earth’s moon, pick a point on the Earth’s orbit to be the Earth’s position. Around that point, draw a circle of 5 mm radius (10 mm or 1 cm diameter) to represent the Moon’s orbit.

Table 1. Drawing Orbits in Scale Model

Orbit	Loop		Pin 2 from Sun	
	Circumference (knot to knot)	# pins	Distance	Angle
Mercury	18 cm	2	3.1 cm	270°
Venus	27 cm	1	--	--
Earth	39 cm	1	--	--
Mars	64 cm	2	5.6 cm	45°
Asteroid Belt: Inner Edge	84 cm	1	--	--
Asteroid Belt: Outer Edge	122 cm	1	--	--
Asteroid Ceres	114 cm	2	8.4 cm	78°
Asteroid 1983RD	118 cm	2	39 cm	173°
Asteroid Icarus	85 cm	2	38 cm	330°

4. Adding the Sun and Planets.

To complete the model, add the Sun and planets at the same scale as their orbits. Real and to-scale diameters are given in Table 2. At this scale the Sun should be a ball just under 2 mm diameter, about the size of a BB or a ball bearing from a bicycle.

The Earth and Venus should be 1/50 mm across, which is almost invisible; smaller than a grain of salt or a pin-prick in paper (~1/5 mm), and about the thickness of standard copier paper. A single dot out of a half-tone print (as in a magazine) is about 3 times too large, but gives the

right idea of scale. The individual dots in a half-tone print can be seen with a 5 or 10X magnifying glass. The Moon, Mercury, Mars and the asteroids are too small to be visible at this scale!

5. Discussion.

Encourage students to share their observations about size and scale as they construct and view the scale model. Help students to observe that there is mostly open space in the solar system. Lead students to the observation that Earth is a small moving target and is not frequently hit by large impacting asteroids or comets.

Table 2. Real and Scaled Diameters of Solar System Objects

Object	Real Diameter	Scaled Diameter
Sun	1,400,000 km	1.8 mm
Mercury	4,880 km	1/150 mm
Venus	12,100 km	~1/50 mm
Earth	12,800 km	~1/50 mm
Moon	3,480 km	1/200 mm
Mars	6,800 km	~1/100 mm
Ceres	940 km	~1/1000 mm
1983RD	0.8 km	~1x10 ⁻⁶ mm
Icarus	0.9 km	~1x10 ⁻⁶ mm

6. Optional - Upper Grades

Asteroid Icarus in the Third Dimension. The orbits of all the planets (except Pluto) and most of the asteroids are nearly in the same plane, the **ecliptic plane**. In the model, the ecliptic plane is the main cardboard. The asteroid Icarus orbits outside the ecliptic, and so provides an exercise in three-dimensional geometry.

On a separate piece of cardboard, draw an ellipse following the method of Activity A with the string length and pin distance for Icarus from Table 1. Cut out the ellipse. Draw a straight pencil line through the pin holes from one end of the ellipse to the other. Select one pin hole to be the Sun's location. Draw a straight pencil line through the Sun pin hole at a 30° angle to the end-to-end line; this last line is at the intersection of Icarus's ellipse and the ecliptic plane. Measure and write down the lengths of this intersection line on both sides of the Sun hole; the distances will not be the same. In the ellipse, cut out a hole about 1 cm diameter around the Sun point.

On the main solar system board, cut a slit through the Sun position as long as the intersection line, so that the Sun point on the main board and the Sun hole in the Icarus ellipse can coincide. The slit may be at any convenient orientation; to make the model exact, cut the slit at an angle of 87° clockwise from the reference line, with the shorter part of the slit pointing to 87° and the longer part pointing to 273°.

To attach the Icarus ellipse to the main board, insert the Sun end of the ellipse into the slit from below the main board. Adjust the ellipse so that the intersection line is at the main board, and the Sun point of the main board and the Sun hole on the ellipse coincide. Tape in place along the intersection line.

Finally, tilt the Icarus ellipse (flexing the tape along the intersection line) so that its plane makes a 25° angle to the main board (ecliptic plane). Tape or wire in place. Reinforce as needed to correct possible sagging.

Extensions

1. Who was Icarus? Why name this particular asteroid after him? Another asteroid with a similar orbit is named Phaethon. Who was Phaethon, and why might an asteroid be named after him?
2. At the scale of this model, a light year (the distance light travels in a year) is about 12.1 km. In this model, how far from the Sun would it be to the nearest star, Proxima Centauri at 4.3 light years distance? (52 km) How far to the nearest star visible in the Northern Hemisphere, Sirius at 8 light years distance? (96.8 km) At this scale, how far away is the center of our Milky Way galaxy at 30,000 light years distance? (363,000 km) How is this image of the distances between stars different from the images shown in TV shows or movies about space? (Space is more empty and much larger than it is usually depicted.) (See Table 3 for additional information.)
3. View the video “Powers of 10.”

Table 3. Solar System and Nearest Star at this Scale

Distances are averages from Sun, except for Earth’s Moon* which is from Earth.

Object	Real		Scaled	
	Distance	Diameter	Distance	Diameter
Sun	---	1,400,000 km	---	1.8 mm
Mercury	58 million km	4,880 km	7.3 cm	0.005 mm
Venus	108 million km	12,100 km	13.8 cm	0.015 mm
Earth	150 million km	12,800 km	19.5 cm	0.016 mm
Moon *	0.38 million km	3,480 km	0.49 cm	~0.004mm
Mars	228 million km	6,800 km	32 cm	0.09 mm
Asteroid Belt:	330 million km	---	42 cm	---
Inner Edge				
Asteroid Belt:	480 million km	---	61 cm	---
Outer Edge				
Jupiter	778 million km	143,200 km	1.0 m	0.18 mm
Saturn	1.42 billion km	120,000 km	1.9 m	0.15 mm
Uranus	2.87 billion km	51,800 km	3.7 m	0.06 mm
Neptune	4.48 billion km	49,500 km	5.8 m	0.06 mm
Pluto	7.4 billion km	2300 km	9.4 m	0.004 mm
(Aphelion- farthest point from Sun)				
Alpha Centauri (Star)	4.1x10 ¹³ km or 41 trillion km	2,500,000 km	52 km	~3 mm

Lesson 4 — The Meteorite-Asteroid Connection

Activity C: Collision Course

Objectives

Students will:

- graph the locations of the Earth and a near-Earth asteroid.
- observe from the graph that both time and location in space are important.
- estimate when an asteroid would cross the Earth's orbit.
- determine if a collision would take place.

Procedure

Advanced Preparation

1. Have materials ready. Instructor may prepare the papers and the circular Earth orbit as in Part 1. Use a string, 30 cm knot to knot. The instructor may choose to draw the Earth orbit with a pushpin and string, or any other method. Distances in Table 4 assume that the Earth orbit is 30 cm diameter, and can be scaled for other sizes.

Classroom Procedure

1. Get Set . . . (Earth's orbit)

Each team should mark the Sun point at the center of its paper, and a pencil line from the Sun extending 30 cm in any direction. This will be the reference line from which angles are measured (see diagram below).

2. Go! (Graphing orbits)

Each team should graph the orbit of the Earth and the orbit of one asteroid on their paper. To draw an orbit from the numbers in Table 4, begin with a single time at the left of the Table 4. On that line in the Table, read the angle and distance for that time in the orbit.

On the large piece of paper, use a protractor to measure the angle (clockwise) from the Sun and the reference line, and draw a line at that angle. Measure outward along that line to the distance listed in the table, and draw a mark at that distance (color-coded, perhaps). Label the mark with the month and half-month.

After all the points are graphed and labeled, connect them freehand to make a smooth curve. The points may not make a full orbit.

About This Activity

For Advanced Students

Even if the orbit of an asteroid crosses the orbit of the Earth, there may be no collision if the asteroid and Earth are at different places in their orbits. In this exercise, each group of students will graph orbit positions of the Earth and an asteroid. Students will compare their results, and see which asteroid makes the closest approach.

Materials for Activity C

- Kraft or butcher paper, approx. 60 cm x 60 cm for each group
- pencil/pen (*colored pencils optional*)
- rulers, one per group
- protractors, one per group
- Table 4 (*pg. 4.11*)

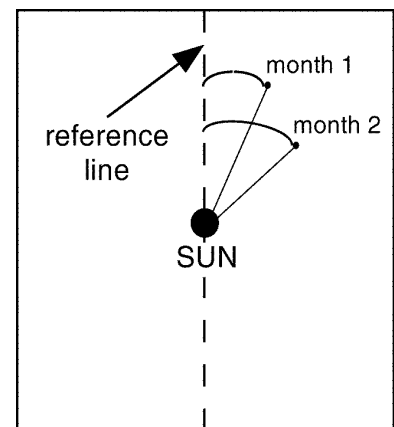

Graphing Asteroid Orbits

3. And the Winner Is . . .

Each team should then estimate when (month number and a fraction) their asteroid crosses the Earth's orbit. Then, each team should measure the closest approach between their asteroid and the Earth, by measuring the distance between corresponding time steps in their orbits. Which asteroid comes closest to hitting the Earth? How close does the closest asteroid really come to the Earth?

The scale here is 1 cm = 10,000,000 kilometers, and the Earth (to scale) would be 1/100 mm.

Note: This scale is not the same as in Activity B!

Extensions

1. The speed of an asteroid (distance/time) can be estimated here as the distance between successive points from Table 4. How does the speed of an asteroid change as it goes through its orbit (perhaps students could graph speed versus distance from the Sun)? How fast is each asteroid going as it passes Earth's orbit? If the asteroid(s) hit the Earth, would the differences in speed have any effect on the force of the impact or the size of a resulting crater? (See Lesson 6)
2. The distance between the Earth and an asteroid depends on the relative positions of both the asteroid and the Earth. Tabulate the distances between the Earth and the asteroids through time and make graphs of distance versus time. Why do the graphs have hills and valleys?
3. Astronomers have to know where in the sky to look for asteroids in order to study them. They measure directions in the sky as angles compared to a reference direction, just as on the drawings in Activity C. To find out where in the sky you would look for your team's asteroid, pick a time point for the Earth, and draw a line through that point parallel to your reference line (that goes through the Sun). Draw another line from the Earth to the asteroid's position at that time point. Measure and write down the angle between these two lines; this is the direction (the longitude) in the sky you would have to look (to an astronomer, the "right ascension"). For your team's asteroid, tabulate the directions you would have to look from Earth, and graph that angle versus time. Does your asteroid appear to move at a constant speed in the sky? Do any of the asteroids appear to move backwards (retrograde motion)?

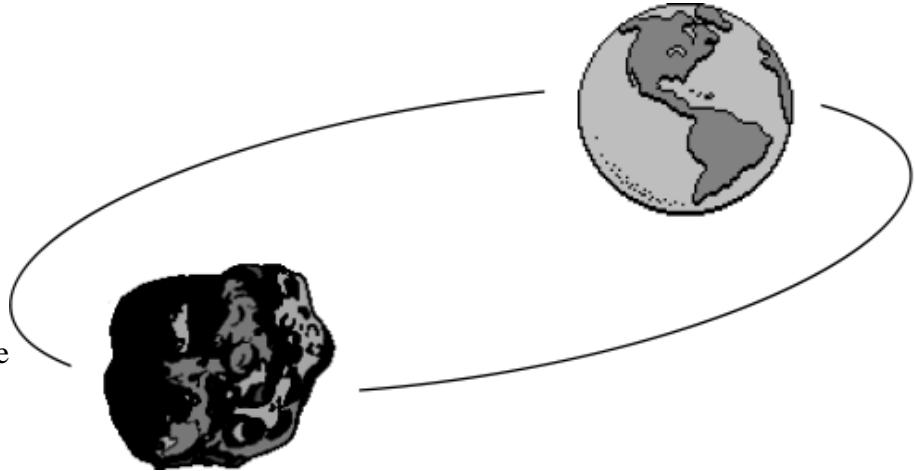

Table 4. Distances from Sun and Angles from Reference Line for Earth and Asteroids

Month	Earth		Asteroid 1		Asteroid 2		Asteroid 3		Asteroid 4		Asteroid 5		Asteroid 6	
	Dist	Angle	Dist	Angle	Dist	Angle	Dist	Angle	Dist	Angle	Dist	Angle	Dist	Angle
0	15 cm	0°	8.4 cm	0°	23.7 cm	322°	30.6 cm	195°	55.4 cm	50°	23.6 cm	56°	51.1 cm	261°
1	15 cm	30°	10.8 cm	72°	23.5 cm	333°	27.0 cm	205°	53.9 cm	48°	21.4 cm	71°	49.5 cm	264°
2	15 cm	60°	14.8 cm	110°	22.6 cm	344°	23.1 cm	218°	52.1 cm	46°	19.0 cm	90°	47.7 cm	267°
3	15 cm	90°	18.2 cm	133°	20.8 cm	356°	19.2 cm	236°	50.1 cm	44°	16.7 cm	115°	45.6 cm	270°
4	15 cm	120°	20.7 cm	149°	18.2 cm	11°	15.6 cm	263°	47.7 cm	42°	15.0 cm	146°	43.2 cm	273°
5	15 cm	150°	22.4 cm	162°	14.7 cm	30°	13.4 cm	303°	45.1 cm	40°	14.6 cm	182°	40.4 cm	277°
6	15 cm	180°	23.3 cm	174°	10.8 cm	59°	14.1 cm	347°	42.0 cm	37°	15.5 cm	216°	37.4 cm	282°
7	15 cm	210°	23.3 cm	185°	8.6 cm	113°	17.2 cm	21°	38.6 cm	33°	17.5 cm	245°	33.9 cm	288°
8	15 cm	240°	22.5 cm	197°	11.1 cm	192°	21.0 cm	43°	34.7 cm	29°	19.9 cm	276°	30.1 cm	294°
9	15 cm	270°	20.9 cm	210°	15.0 cm	244°	25.0 cm	59°	30.3 cm	24°	22.2 cm	285°	25.8 cm	303°
10	15 cm	300°	18.5 cm	225°	18.4 cm	272°	28.8 cm	70°	25.2 cm	17°	24.4 cm	299°	20.9 cm	316°
11	15 cm	330°	15.2 cm	247°	20.9 cm	290°	32.2 cm	79°	19.1 cm	6°	26.2 cm	311°	15.6 cm	338°
12	15 cm	0°	11.2 cm	283°	22.7 cm	304°	35.4 cm	86°	11.9 cm	342°	27.7 cm	321°	10.7 cm	21°
13	15 cm	30°	8.5 cm	352°	23.6 cm	317°	38.3 cm	92°	5.4 cm	240°	28.8 cm	331°	10.0 cm	94°

Asteroid 1 = Castalia, (0 month is 1.5 months after perihelion at 0°)
 Asteroid 2 = Cerebrus, (oriented so perihelion is on-line with Earth and Sun)
 Asteroid 3 = Antinous, (starting 71 half-months after perihelion)
 Asteroid 4 = Hephiaistos, (starting at perihelion, but turned to retrograde orbit)
 Asteroid 5 = Nereus, (arranged for a near-miss)
 Asteroid 6 = Oljato, (starting at 51 half-months after perihelion, angle advanced by 85°)

Objectives

Students will:

- gather data by observing, measuring, and manipulating objects.
- record observations, analyze data and draw analogies.
- compare samples of similar materials.
- measure and record the brightness of light in a spectrum produced from a prism.
- discover that white light is composed of the spectrum of colors and that some light is invisible to the human eye.
- participate in introductory quantitative spectroscopy experiments.
- set up and conduct an experiment to analyze reflected light.
- recognize that different materials reflect different proportions of incident light.

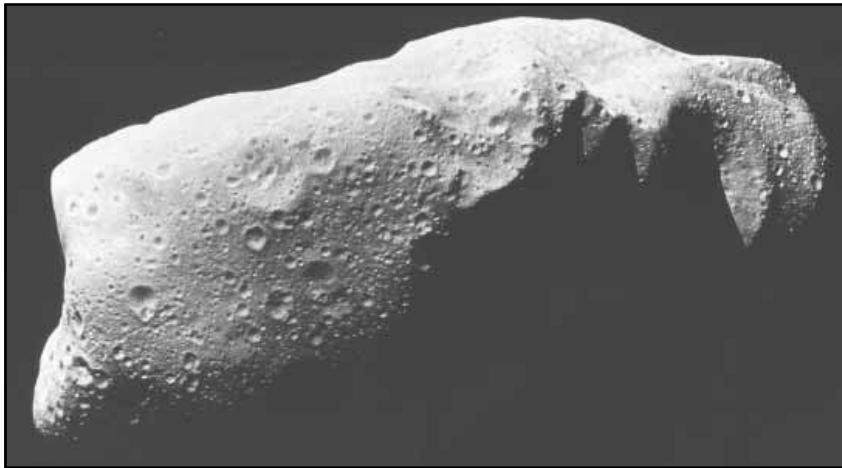

Asteroid Ida

“Where do they come from?”

About This Lesson

This lesson is about the connection between meteorites and asteroids. The activities in this lesson focus on ways to look at asteroids because some scientists think that some meteorites are fragments of asteroids. The lesson centers on remote sensing techniques using light. Students consider the brightness (reflectivity), textures, and colors of materials.

The lesson is arranged as three work stations, an optional station, and a central station with the Meteorite Sample Disk. The Meteorite Sample Disk or photographs of the meteorites must be available so students may examine the meteorite samples in light of the experimental results at each station. This lesson could be done simultaneously by four separate groups, one for each station, as no station relies on the results of another. All stations except Station 1 could be used as independent exercises.

Background

Most meteorites that land on Earth are thought to come from the asteroid belt. The connection between meteorites and asteroids was suggested as soon as the asteroid belt was discovered. Asteroids come in many sizes, from 900 km down to the limits of visibility in Earth based telescopes at about 1 km. Astronomers assume that there are abundant dust size asteroid fragments also.

It is almost certain that some meteorites came from asteroids. We know this because some meteorite orbits have been traced to the asteroid belt. Scientists have learned this by triangulating meteorite orbits from photographs of meteors.

Many meteors are linked to comets. Yearly meteor showers occur as the Earth passes through the debris left by passing comets. But no meteorites are known to have come from meteor showers. Scientists think this is because the meteors in showers are made mostly of ice and dust, which melt and vaporize when they encounter the Earth's atmosphere. However, someday scientists may find meteorites from comets.

There are many different kinds of meteorites, as shown in the Meteorite Sample Disk, and scientists wondered if there might also be different kinds of asteroids. Since we have not yet sampled asteroids directly, scientists have had to rely on telescopic measurements of the colors (spectra) of asteroids. In spectroscopy studies, light from asteroids (reflected sunlight) is taken into the telescope, directed through a prism or diffraction grating, and spread out into its spectrum. Then the scientists measure how bright the light is at each color (wavelength) in the spectrum. These reflection spectra can be characteristic of certain minerals or metals on the asteroid surface, or even indicate the presence of water ice. In this way, astronomers can estimate the composition of asteroids and try to correlate them with meteorites.

There are asteroid color spectra types that seem to be similar to most types of meteorites, including some chondrites, some achondrites, irons, and stony irons. But there are many types of asteroids with spectra that do not correspond to spectra of known meteorites. Perhaps there are many more kinds of materials in the asteroid belt just waiting to fall as meteorites. On the other hand, there may be effects on the surfaces of asteroids that change their colors in ways we do not now understand.

Additional information is available in the Teacher's Guide and in the background sections of Lesson 4 (pg. 4.2) and Lesson 17 (pg. 17.1).

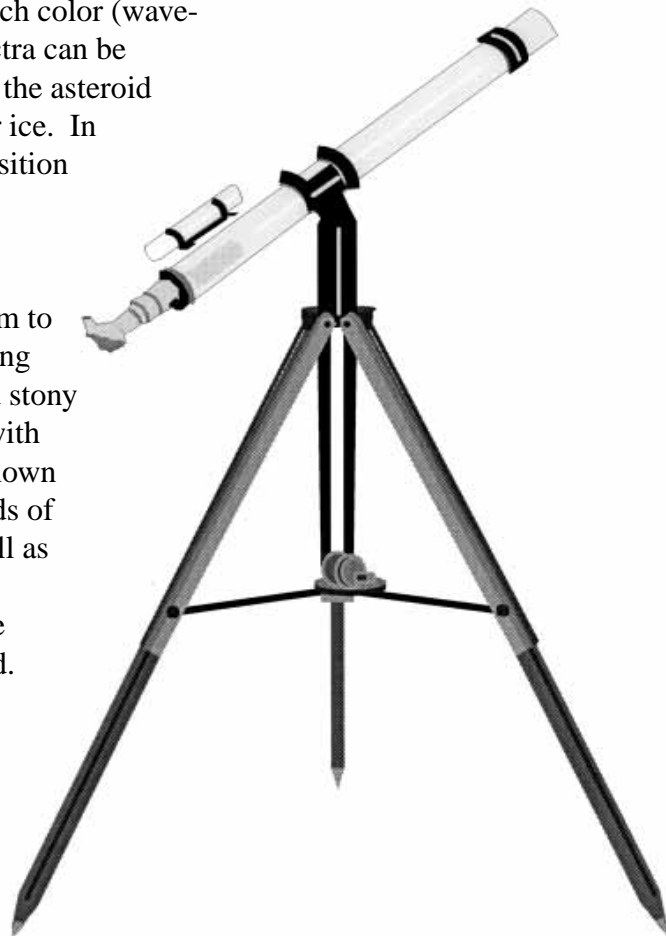

Lesson 5 — Looking at Asteroids

Station 1: Meteorite Sample Disk

Objective

Students will:

- observe, and compare meteorites.

Procedure

Students will proceed to this station to answer questions from other stations.

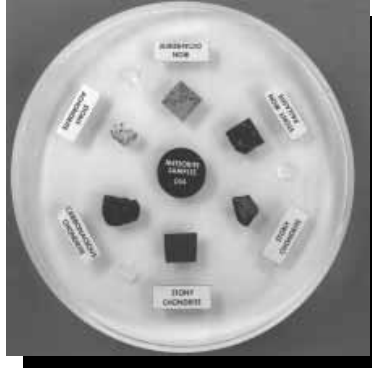

About This Station

The meteorites are used to reinforce student's observation and deduction skills.

Materials for Station 1

- Meteorite Sample Disk
- magnifier
- binocular microscope
(optional)

Station 2: Test Your Metal

Objectives

Students will:

- observe and compare samples of metal and record their observations.
- prepare samples for observation.

Procedure

Advanced Preparation

1. Set up station with nail and file, a sheet of white paper, and a magnifying glass.

Classroom Procedure

1. Students examine the nail or metal pipe. Have one student in each group file the nail or metal pipe until they have a small pile of fine filings. Students examine the iron filings (without spilling or losing them) noting their size, shape, and color. Particularly note the variations of color. Students should take notes on their observations in their lab notebook or on the Lab Sheet. Answer questions found on separate sheet after experiment.

2. At the Meteorite Sample Disk, students should examine the metal in at least two of the meteorite samples and record their observations in their lab notebook or Lab Sheet.

Note: Help students determine how they can tell metal from the other minerals in the meteorite samples by reading the descriptions provided with the Meteorite Sample Disk.

About This Station

By looking at iron metal and then making very small iron filings, students will observe how different something can be when different sizes and surface treatments are viewed. Careful observations of the meteorites will reveal that the metal looks different from sample to sample.

Materials for Station 2

- large nail or small piece of metal piping
- metal file
- one sheet of white paper
- Lab Sheet (pg. 5.9)
- Questions (pg. 5.11)
- magnifier
(optional)
- pencil/pen

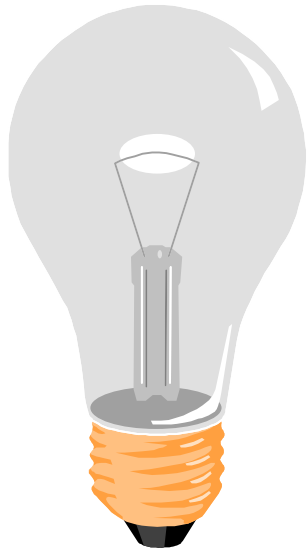

About This Station

Through demonstrations and analysis, students will discover that different materials reflect different proportions of the light that strikes them. The proportion of light that is reflected (“reflectance”) is shown to be important in determining the compositions of distant objects (e.g. asteroids).

Materials for Station 3

- 8 cm squares of construction paper; one each of red, black, blue, and white
- 1 thermometer
- incandescent light source
- 2 ring stands or other tall supports for clamps
- two clamps or other means of supporting equipment (*duct tape*)
- cardboard large enough to shield thermometer
- ~50 cm square of non-shiny black paper or cloth (*blotter paper works well*)
- Lab Sheet (pg. 5.9)
- Questions (pgs. 5.11-5.12)
- pencil/pen

Suggest they look for shiny spots or rusty spots. Also help students consider that there might be differences in the composition of the metal, the size of grains, surface roughness, and the way the metal was treated in the laboratory.

3. Students can then return to the station, re-examine the iron filings, and record their observations comparing the appearance of iron filings with the iron in the meteorite samples.
4. Clean area before next group arrives.

Lesson 5 — Looking at Asteroids

Station 3: Reflections on Light and Heat

Objectives

Students will:

- set up and conduct an experiment to analyze reflected light.
- observe that different materials reflect different proportions of incident light.

Background See the information with the questions on page 5.11.

Procedure

Advanced Preparation

1. Set up experiment so that:
 - light is incident on the black paper or cloth at approximately a 45° angle,
 - the thermometer bulb is located in the path of light reflected at 45°,
 - the cardboard shields the thermometer from direct light (see Figure 1).

Classroom Procedure

1. Place color construction paper squares on the large black paper so that the incident light shines equally on all colors, and they are all viewed easily.
2. Rank the relative brightness of the papers. Touch each paper, and rank the relative temperatures of the papers. Record the results on the lab sheets. Remove all papers from under the lights.
3. Adjust the temperature experiment equipment. Read the thermometer and record the temperature.

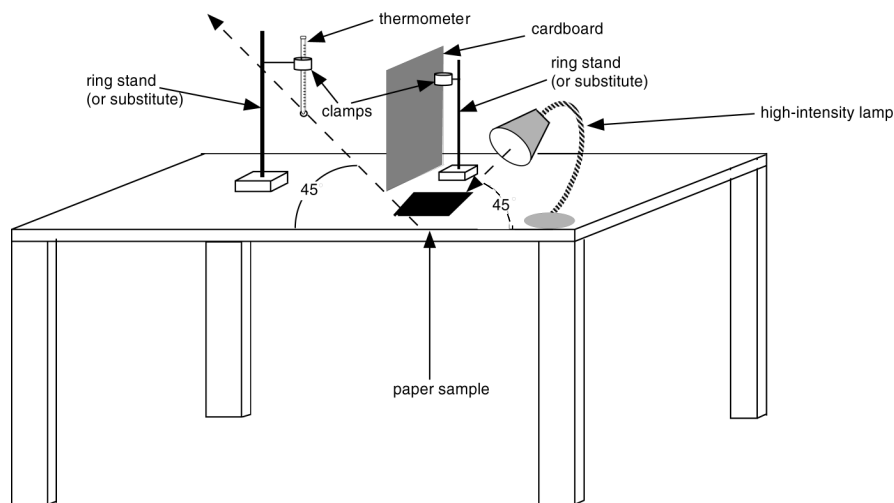

Figure 1

4. Place one colored piece of paper where the incident light will strike it at a 45° angle. Wait five minutes and read the thermometer; record the results. Allow thermometer to return to room temperature.
5. Repeat for each color of paper. Groups may do only one color if there are time limitations. Share data.
6. After completing the experiment answer the questions found on the separate sheet.
7. Discuss experimental results. (See Background pg. 5.2)

Lesson 5 — Looking at Asteroids

Station 4: The Visible Spectrum and Beyond!

Objectives

Students will:

- measure and record the brightness of light in a spectrum produced from a prism.
- observe that white light is composed of the spectrum of colors and that some electromagnetic energy is invisible to the human eye.
- participate in introductory quantitative spectroscopy experiments.

Vocabulary

electromagnetic spectrum, spectroscopy, infrared, ultraviolet, voltage

Vocabulary

reflectance, reflected, diffracted, incident light, incandescent light, emit

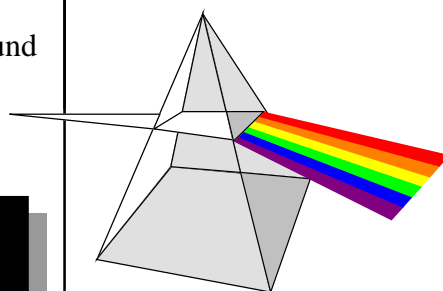

About This Station

The teacher will display a visible spectrum using light from an overhead projector (or other light source). As an introduction to quantitative spectroscopy, students will measure and record parts of the electromagnetic spectrum. Students will discover that white light is composed of the spectrum of colors, that the energy output of the electromagnetic spectrum can be measured, and that some wavelengths of the spectrum are invisible to the human eye.

Station 4: Method 1

Materials for Station 4 (Method 1)

- voltmeter (or other means of measuring power output, ex: small motor-driven fan, solar energy kit, etc.)
- solar cell, masked with tape so that light can hit a patch only about 2-3 mm wide
- tape (duct or electrical)
- overhead projector (as light source)
- glass prism
- cardboard to cover most of projector surface (to reduce glare from projector)
- white poster or other surface for “catching” color spectrum
- wall chart with electromagnetic spectrum
- Lab Sheet (pg. 5.10)
- Questions (pg. 5.12) Distribute after experiment
- pencil/pen

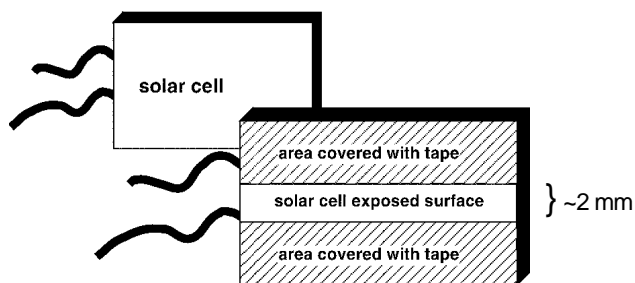

Procedure

Advanced Preparation

1. Teacher will need to experiment with available materials to make a suitable spectrum. A spectrum can be produced with the prism held almost at the edge of the projection surface, and held parallel to the nearest edge of the projection surface (approximately parallel to the lines in the projection lens). Then rotate the prism around an axis parallel to the projection surface until the spectrum projects onto the wall. See the diagram above right.
2. Electromagnetic spectrum chart should be available to students. Include additional instructions if prepared lab sheet is not used. Try this first to make explanations easier. **Note:** If you are familiar with using a diffraction grating, you may prefer to use it with an overhead projector to display a visible spectrum.

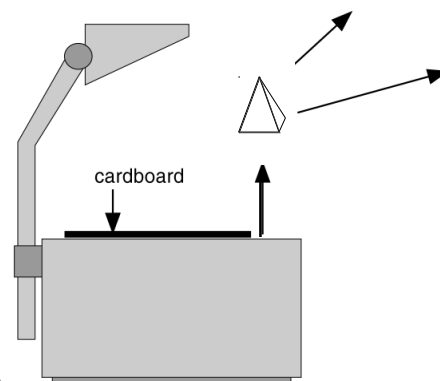

Classroom Procedures

1. Turn on overhead projector with light projecting onto ceiling or upper wall.
2. Use cardboard to block extra light from overhead projector.
3. Allow light from projecting surface to pass through prism.
4. Experiment with positions and angles to create the most clearly defined spectrum possible.
5. “Catch” light spectrum on a poster board, and tape the poster on the wall.
6. Connect the voltmeter (or motor, etc.) to the solar cell.
7. Orient the solar cell so that only a single color of light hits the unmasked band (see solar cell diagram above left). Move the solar cell through the spectrum on the wall, noting the **relative** power from each spectral color (either voltage on the voltmeter, or how fast the motor runs). Be sure to move the solar cell above and below the spectrum, i.e. beyond the red (Infrared or IR) and beyond the violet (Ultraviolet or UV).
8. Record information on Lab Sheet, answer Questions, and discuss results.

Note: Be sure to test areas bordering, but away from the spectrum for control purposes.

Also, some new projectors have IR filters to reduce heat, therefore you may not get power in the IR range.

Station 4: Method 2

Procedure

Advanced Preparation

1. Make an opaque screen approximately 25 cm square from a piece of cardboard or poster board. Cut a 5 cm-diameter hole out of the middle. Tape two pieces of opaque paper or aluminum foil over the hole so that there is a vertical gap between them that is no wider than 1 mm.
2. Arrange the equipment and darken the room. Adjust equipment so projector light does not extend around the edges of the opaque screen, and the visible spectrum is displayed on the screen.

Classroom Procedures

1. See steps 6-8 in procedure for Method 1.

Questions

1. Why is there power output beyond the red light? **There is electromagnetic energy at wavelengths that our eyes cannot see; students have probably had experience with infrared — TV remote controls operate using infrared.**
2. Why might the solar cell produce little power from blue or purple light, even though we can see blue and purple? **The solar cell is not as sensitive to blue and purple as our eyes are.**

Lesson 5 — Looking at Asteroids

Optional: The Color Black

Objectives

Students will:

- set up and conduct a simple liquid chromatography experiment.
- record observations and draw analogies.

Note: Chromatography is not used by scientists to determine the composition of asteroids, however, this is an easy, inexpensive laboratory exercise that reinforces the concept of separating useful data to analyze a complex system.

Materials for Station 4 (2)

- slide projector
- opaque screen (*see materials and instructions below*)
- glass prism
- supports for screen and prism (*books and or tape*)
- projection screen or white poster board
- Lab Sheet (pg. 5.10)
- Questions (pg. 5.12)
Distribute after experiment

About This Station

By a simple chromatography experiment, students will learn that one color may be made up of a mixture of different colors just as white light is a combination of light at different wavelengths. This will introduce the concept that the color of an object (asteroid) can be used to infer the composition of the object.

Vocabulary

chromatography, wick, absorbent

Materials for The Color Black

Amounts will vary according to the method of presentation. Group size from 4-6.

- 4 black felt-tipped, water soluble markers (*each marker a different brand*)
- 4 transparent containers (*beaker-like*) with water at a 2 cm depth
- 8 pieces of filter paper, approximately 10 cm x 2 cm (*coffee filters work well*)
- 4 pencils or wooden sticks
- absorbent paper
- scissors
- The Color Black worksheet (pgs. 5.13-5.14)
- map pencils or crayons
- ball-point pen
- metric ruler

Procedure

Advanced Preparation

1. Assemble materials.
2. Cut filter paper as needed so that there are two strips for each marker.
3. Prepare containers of water, one per marker. Students re-use water but not papers.
4. Make sure absorbent paper is on hand for spills and for the finished chromatograms.

Classroom Procedure

1. Select a marker, two strips of filter paper, a pencil, and a container of water.
2. Using the marker, place a dot about 3 cm from one end of a strip. Make a second dot of equal size using the same marker on the second strip of paper. You should have two identical strips.
3. At the opposite end, using a ball point pen, label each strip with the brand name of the marker and a student's initials.
4. Place one of each pair of strips on a sheet of absorbent paper. Place the matching strip next to it for a reference strip for later comparison.
5. Repeat for all four markers (group members may do this simultaneously).
6. On the worksheet, under Filter Description, describe the color of the dots for each marker and note if any have tints of a different color in them.
7. Record what you predict will happen when the strip is suspended in water.
8. Take the filter paper strip from the absorbent paper and wrap the labeled end around the middle of a pencil so that the paper will stay in place when the pencil is lifted.
9. Carefully place the dot end in the container of water so that the filter paper, **but not the dot**, is in the water. Rest the pencil on the rim of the container, rolling the strip up or down if necessary (see diagram). Repeat for each filter paper strip.
10. Allow adequate time (~ 3 minutes) for the water to wick up the paper. When the water reaches the top of the paper, carefully remove it from the water and place it on the absorbent paper next to the reference strip.
11. Compare the original black dot with the water treated dot (chromatogram).
12. On the worksheet, write a description of each of the four chromatograms.
13. Answer questions and discuss results.

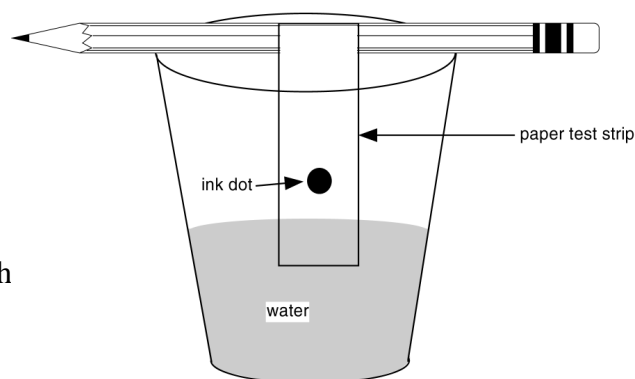

Lesson 5 — Looking at Asteroids
Lab Sheet: Stations 2-4

Name _____

Date _____

Station 2: Test Your Metal

Describe what happened to the metal when you made the iron filings. What did the filings look like? Describe any changes and explain.

Metal In Meteorites Description

Meteorite name	Description of the metal	Does the metal resemble the iron filings? (describe how it is alike or different)
_____	_____	_____
_____	_____	_____
_____	_____	_____

Station 3: Reflections on Light and Heat

Paper Color	Brightness 1= bright 4 = not bright	Touch Temp. 1= hottest 4 = coldest	Thermometer Reading	
			before	after
Black	_____	_____	_____	_____
Red	_____	_____	_____	_____
Blue	_____	_____	_____	_____
White	_____	_____	_____	_____

Reflectance Bar Graph (show color verses degrees)

Station 4: The Visible Spectrum and Beyond

Which bands generate the greatest power?

Color

Volt Meter Reading or Relative Motor Power

Control Area

Graph of Voltage vs. Color of Light

voltage
(label units)

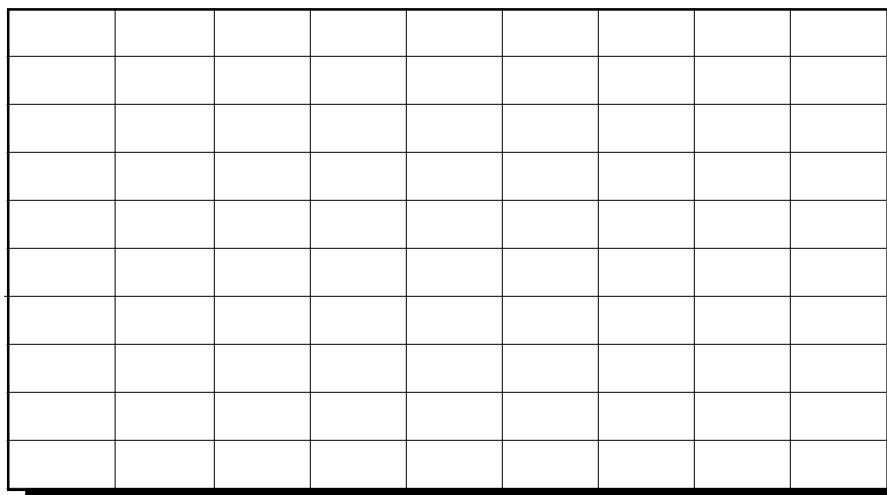

I-R Red O Y G Blue I V UV

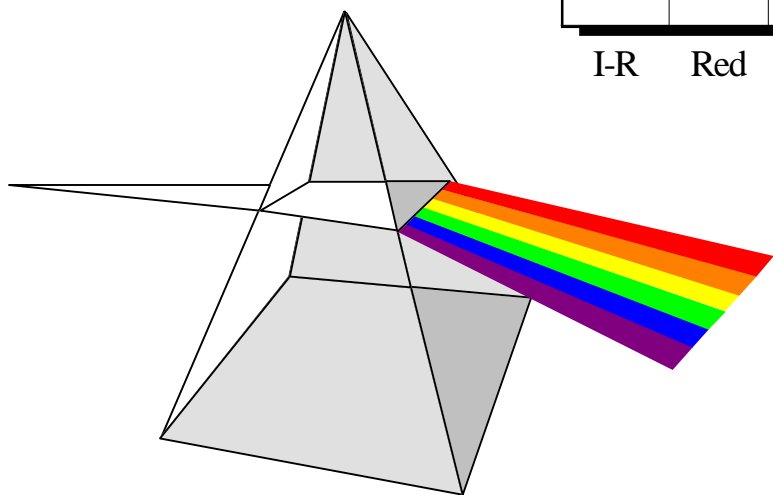

*Teacher Note: use these questions **after** each station, do not distribute before activity.*

Station 2: Test Your Metal

1. Why are the iron filings dark and the metal in some of the meteorites shiny?
2. If an asteroid were made of metal, would it be shiny?

Station 3: Reflections on Light and Heat

1. Which color reflected the most light?



Was that color hottest to the touch?

Did the color which was hottest to the touch cause the highest temperature on the thermometer?

Why did this happen?

2. Scientists can understand more about the surface composition and texture of asteroids by measuring how much visible and infrared energy is reflected or emitted. Scientists can measure the surface temperatures of asteroids by measuring how much absorbed solar energy they emit as infrared energy.

Return to the meteorite disk to consider these questions based on your experimental results: Do you think an asteroid made of carbonaceous chondrite material would be hotter or colder than an asteroid of achondrite material? Why?

How do you think an iron meteorite's infrared reflectance would be compared to a carbonaceous chondrite's reflectance?

How would its distance from the Sun affect the temperature of an asteroid?

- Advanced:** You measured color reflectance of objects. Scientists measure color brightness of planetary bodies and compare those levels of brightness to known levels. In this way they are able to classify asteroids according to their components. For example, frozen water (ice) would look white and, therefore, very bright.

Using your findings, how would we set up a comparison table for analyzing reflectance?

Station 4: The Visible Spectrum and Beyond

- Why is there power output beyond the red light?
- Why might the solar cell produce little power from blue or purple light, even though we can see blue and purple? Hint: Think about how sensitive our eyes are and the sensitivity of the solar cell.
- Can you feel heat from the infrared?

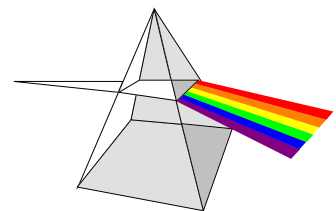

Lesson 5 — Looking at Asteroids
The Color Black

Name _____

Date _____

Filter Description

Chromatogram Description

Prediction

Student Background (*Read after completing The Color Black station.*)

Just as you have probably attempted to create new colors for art by mixing colors you already have, many colors are a combination of two or more colors (e.g. red + yellow = orange). **The experiment you have conducted works the other way.** You started with the “new” color — black — and revealed which colors were used to create it.

It’s rather like when you have a mixture of colored candies and want to know how many candies of each color are in the bag. They have to be separated first. We often go from general observations to specific ones in our attempts to understand things. For example you could start with a bag of colored candies as a general observation and then be specific and state that you have 6 yellow candies, 7 green ones, 4 red ones.

Substances have specific properties (color, shape, texture). The more properties we can identify, the greater our ability to understand and classify new substances. The better we can classify, the better we can see relationships among substances, objects, organisms, and occurrences. That process is similar to a detective’s work and can be VERY exciting!

Scientists are working as detectives to determine the composition of the asteroids. The color of the surface of an asteroid gives scientists clues to its mineral content.

Another way scientists investigate the composition of asteroids is to look at the light reflected from the surface of an asteroid. Then they compare that light signature or spectrum with spectrum of known substances on Earth. This technique is used to compare asteroids and meteorites. They attempt to determine whether asteroids have similar compositions to known meteorite types.

The chromatography experiment you completed is **not used by scientists** to determine the composition of asteroids. This experiment was designed so that you could easily experience the investigative process of science and to allow you to see that substances are often made of more than you realize!

Neither of the techniques to determine mineral compositions on asteroids works as easily as the liquid chromatography experiment you have conducted. However, you now have experience as an investigative scientist.

Questions (*Use only after you have completed the experiment.*)

1. What clues gave you a hint that the black inks might be made of different colors?
2. Did any of the chromatograms have similar colors in similar places? Explain.

Return to the Meteorite Sample Disk to consider the next question.

3. Write a short comparison among the black meteorite samples, comparing and contrasting how black they are, and whether they are different shades or tints of black.
4. What techniques do scientists use to determine the mineral content of asteroids?
5. How can meteorites help scientists understand more about asteroids?
6. **Extra:** Most asteroids are quite dark, and reflect only 10-20% of the light that hits them. This is very much like the Moon, where the bright areas of the Moon (the highlands) reflect about 20% and the dark areas (the mare) reflect about 10%. Using references available in your classroom, investigate the composition of the different parts of the Moon and why they are brighter or darker.

Lesson 6 — Impact Craters— Holes in the Ground!

Objectives

Students will:

- model impact craters in the lab.
- identify various structures caused by the cratering process.
- manipulate the conditions that control the size and appearance of impact craters.
- state the relationships between the size of the crater, size of the projectile, and velocity.
- demonstrate the transfer of energy in the cratering process.

Background

Impact craters are formed when pieces of asteroids or comets strike the surface of a planetary body. Craters are found on all the terrestrial planets, on the Earth's Moon, and on most satellites of planets.

Various geological clues and studies of the lunar rocks returned by the Apollo missions indicate that about 3.9 billion years ago asteroid-size chunks of matter were abundant in the solar system. This was a time of intense bombardment of the young planets, affecting Earth by breaking up and modifying parts of the crust. Mountain building, plate tectonics, weathering and erosion have largely removed the traces of Earth's early cratering period. But the near absence of weathering on the Moon has allowed the evidence of this ancient time to be preserved.

Impact craters are formed by the transfer of energy from a moving mass (meteorite) to a stationary body (planet). Kinetic energy is the energy of motion. It is defined as one half the mass of an object, times the velocity of the object squared ($K.E. = 1/2 Mv^2$). Objects in space move very fast, so this can be a huge amount of energy! In an impact the kinetic energy of a meteorite is changed into heat that melts rocks and energy that pulverizes and excavates rock. Simplified

“Where do they come from?”

About This Lesson

This lesson allows students to create impact craters in plaster of Paris or layered dry materials. They perform controlled experiments by varying the velocity or mass of an object and observing and measuring the effects.

Vocabulary

crater, impact, projectile, velocity, kinetic energy, mass, gravity, ejecta, rim, meteor

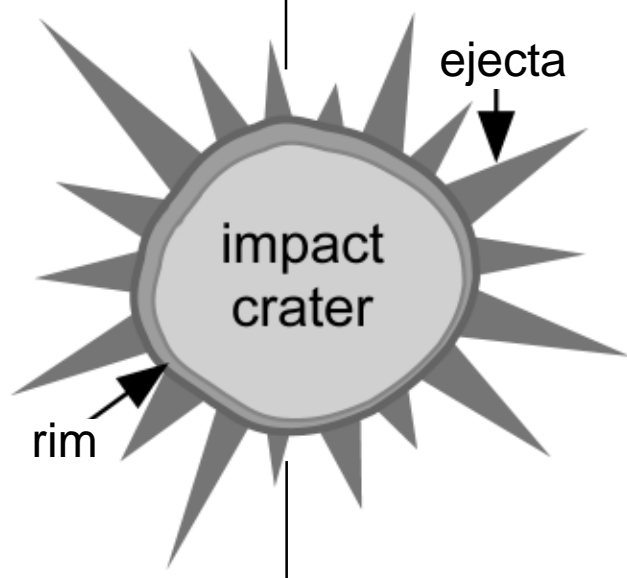

demonstrations of this transfer of energy can be made by creating impacts in powdered materials. If identical objects are impacted into powdered materials from different heights or using different propulsion systems to increase velocities, then students can determine the effect velocity has on the cratering process. Likewise if projectiles of different masses are impacted from the same height and the same velocity, students will be able to identify the relationship of mass to crater formation.

The high velocity impact and explosion of an iron meteorite about 30 meters in diameter could make a crater over one kilometer wide. This is how Meteor Crater in Arizona was formed. In the classroom the low velocities and low masses will make craters much closer in size to the impacting bodies.

Energy Calculations for Advanced Classes

K.E. = kinetic energy

M = mass of impacting object (projectile)

v = velocity of impacting object (projectile)

g = gravity constant for Earth (980 cm/sec²)

h = height of release of impacting object

erg = grams × cm² × sec (measure of K.E.)



$$K.E. = 1/2 Mv^2 \text{ (meteorite impacts like Meteor Crater)}$$

$$v = \sqrt{2gh} \text{ (free fall)}$$

thus

$$K.E. = Mgh \text{ (for classroom experiments)}$$

Classroom Experiment Example

projectile - 10 grams = M

drop height - 2 meters = h

gravity effect - 980 cm/sec² = g

$$K.E. = 1/2 \times 10 \text{ grams} \times 2 \times 980 \text{ cm/sec}^2 \times 200 \text{ cm}$$

$$K.E. = \sim 2 \times 10^6 \text{ ergs}$$

Meteor Crater Estimate

projectile was 30 meters in diameter

iron nickel sphere (meteorite with a density of 8 g/cm³)

projectile 1.1 × 10¹¹ grams = M

$$4/3 \Pi (1.5 \times 10^3)^3 \text{ cm}^3 = v$$

$$(1.4 \times 10^{10} \text{ cm}^3) = v$$

$$K.E. = 1/2 Mv^2$$

$$K.E. = 1/2 \times 1.1 \times 10^{11} \text{ grams} \times (2 \times 10^6)^2$$

$$K.E. = \sim 2 \times 10^{23} \text{ ergs}$$

Lesson 6 — Impact Craters—Holes in the Ground!

Activity A: Making Craters in Plaster of Paris

Objectives

Students will:

- produce easily recognizable crater forms.
- simulate impacts into wet materials.

Procedure

Advanced Preparation

1. Assemble materials.
2. Practice mixing plaster of Paris to get a feel for the hardening time under classroom or outdoor conditions. Plaster for classroom use should be mixed at time of demonstration.
3. Copy one Student Procedure per group.
4. If Lesson 7 will not be completed, then consider whether crater slides could be used in this lesson.
5. Prepare plaster or direct students to mix plaster.
 - Mix the plaster of Paris. A mixture of two parts plaster of Paris to one part water works best. **REMINDER:** The plaster hardens in 10 to 20 minutes, so you must work quickly. Have Data Chart complete and all materials assembled before plaster is mixed.
 - Pour a 5 cm or more layer of plaster in a small deep disposable container.
 - **Optional:** Using a kitchen strainer or a shaker, sprinkle a thin layer of powdered tempera paint over the plaster (use a dust mask and do not get paint on clothes).

Classroom Procedure

1. Discuss background before or during activity.
2. Students work in small groups or conduct classroom demonstration.
3. Follow Student Procedure.
4. Discuss questions.

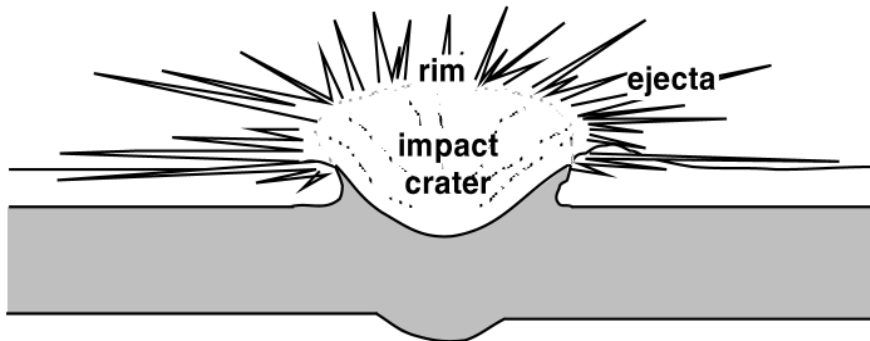

About This Activity

In this activity students create impact craters in plaster of Paris. They may perform controlled experiments by varying the velocity or mass of an object and observing the effects.

Materials for Activity A

- plaster of Paris
- 1 large disposable pan or box (*if used as a whole class demonstration*) or 3-4 small and deep containers such as margarine tubs or loaf pans (*for individuals or groups*)
- mixing container
- stirring sticks
- water (*1 part water to two parts plaster*)
- projectiles (*marbles, pebbles, steel shot, lead fishing sinkers, ball bearings*)
- dry tempera paint, (*optional*) red or blue - (*enough to sprinkle over the surface of the plaster*) or substitute baby powder, flour, corn starch, fine-colored sand, powdered gelatin, or cocoa
- strainer, shaker or sifter to distribute paint evenly
- meter stick
- Student Procedure (*pgs. 6.5-6.6, one per student*)
- dust mask
- Data Charts (*pg. 6.9, one per group*)

About This Activity

Students do controlled cratering experiments in dry materials. They vary the impactor velocity or mass and observe and measure the effects.

Materials for Activity B

- large tray or sturdy box 8-10 cm deep and about 1/2 m on each side (*a cat litter pan works nicely*); 2 per class or 1 per group
- baking soda (2-3 1.8 kg-boxes) per tray, or flour (2 bags, 2.26 kg), or fine sand (*sandbox sand, 3 kg per tray*)
- dry tempera paint - red and/or blue; enough for a thin layer to cover the dry material surface. (*Very fine craft glitter may be used as one color.*) **A nose and mouth dust mask should be used when sprinkling paint.** Suggested substitutes for paint may be found in the materials list for Activity A.
- projectiles (*provide one set of either type for each group of students*)
SET A - (*provide enough sets for all groups*) four marbles, ball bearings, or large sinkers of **identical size and weight**
SET B - (*provide one or two sets per class*) three spheres of **equal size** but **different materials** so that they will have different mass (*example: glass, plastic, rubber, steel, wood*)
- strainer or sifter to distribute the paint
- metric rulers & meter sticks
- lab balance (*one per class*)
- Data Chart (*pg. 6.9, per grp.*)
- Student Procedure (*pgs. 6.7-6.8, one per group*)

Lesson 6 — Impact Craters—Holes in the Ground!

Activity B: Making Craters in Dry Materials

Objectives

Students will:

- manipulate the variables of velocity and mass to investigate crater formation.
- recognize the conditions that control the size and appearance of impact craters.
- state the relationships between the size of the crater, size of the projectile, and velocity.

Procedure

Advanced Preparation

1. Assemble equipment.
2. Prepare projectile sets and label.
3. Copy Student Procedure and Data Charts as needed.
4. Prepare target trays of dry material and paint.
(*Optional: students prepare*)
 - Place 3 cm even layer of dry material in the bottom of a the tray (or box).
 - Sprinkle a thin layer of red powdered tempera paint over the dry material with a kitchen strainer.
 - Place another very thin (2-3 mm) even layer of dry material on top of the tempera paint, just enough to conceal paint.
 - **Optional:** Sprinkle another layer of blue powdered tempera paint on top of the second layer of dry material. Repeat step 6. (*Very fine craft glitter can be used in place of tempera paint for “sparkle” effect.*)

Classroom Procedure

Note: *This procedure is for small groups, it must be modified if the entire class will act as a single group.*

1. Students should work in small groups. Each group should choose at least three projectiles from SET A or SET B.
2. Write a description of each projectile on your Data Chart.
3. Measure the mass, dimensions of each projectile and record on the Data Chart.
4. Drop projectiles into the dry material.
Set A - Drop all projectiles from the same height or several series of experiments may be conducted from different heights. Record data and crater observations.
Set B - Drop the projectiles from different heights (suggest 2-3 m). Record all height data and crater observations.
5. Discuss the effects caused by the variables.

Student Procedure: Activity A

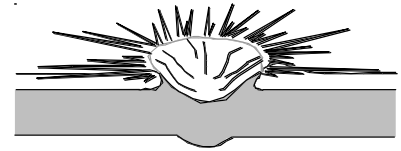

Materials - Per Group

- prepared plaster in container
- projectiles
- tempera paint and sifter (*optional*)
- meter stick
- Data Chart

Procedure

1. Form groups and distribute Data Charts.
2. Each group should choose at least three projectiles.
3. Write a description of each projectile on the Data Chart, including the mass and dimensions.
4. Prepare plaster according to directions from your teacher.
5. Drop the projectiles at 2 minute intervals, recording appropriate information. Each projectile requires an area of about 5x5 cm square. If you drop too many projectiles in an area, your craters will be distorted (though overlapping craters are interesting too).
6. Optional experiment — drop identical projectiles from different heights. Record heights.
7. Leave the projectiles in the plaster and allow it to harden.
8. Write a description of the experiment on the Data Chart. Illustrate and label the craters using the following terms: **rim, ejecta, impact crater.**

Questions

1. Where do you find the thickest ejecta?

2. How do you think the crater rim formed?

3. The powder represents the planet's surface. Any material beneath the top layer must have formed at an earlier time (making it physically older).
If you were to examine a crater on the Moon, where would you find the older material?

Where would you find the younger material? Why?

4. What effect did the time intervals have on crater formation? Why?
5. What effect did different projectiles have on crater formation? (If different projectiles were used.) Why?
6. Since large meteorites often explode at or near the surface, how would the explosion affect impact crater formation?
7. How does the increased drop height affect crater formation? Why?

Student Procedure: Activity B

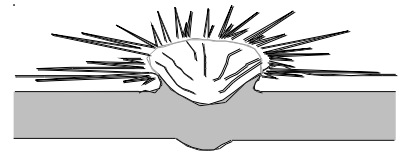

Materials - Per Group

- projectiles SET A and/or SET B (*optional*)
 - SET A** - four marbles, ball bearings, or large sinkers of **identical size and weight**
 - SET B** - three spheres of **equal size** but **different materials** so that they will have different mass
- strainer or sifter to distribute the dry material
- metric ruler and meter stick lab balance (*one per class*) Data Chart

Procedure

1. Each group should choose at least three projectiles from SET A or SET B.
2. Write a description of each projectile on your Data Chart.
3. Measure the mass, dimensions of each projectile and record on the Data Chart.
4. Prepare dry material layers according to directions from your teacher.
5. Drop projectiles into the dry material.
 - Set A** - Drop all projectiles from the same height or several series of experiments may be conducted from different heights. Record data and crater observations.
 - Set B** - Drop the projectiles from different heights. Record all height data and crater observations.
6. Experiment with different velocities by throwing projectiles into dry materials.
7. Discuss the effects caused by the variables.

Options:

- Plot ray length vs. mass when projectile velocity is equal.
- Plot ray length vs. velocity at a constant projectile mass. (Measure ray length from the center of crater to the end of the longest ray for each crater.)

Questions

1. What evidence was there that the energy of the falling projectile was transferred to the ground?

Data Chart: Activity A and B



Date _____
 Names _____

Projectile Description <i>mass (g) dimensions (cm)</i>	Time <i>Activity A only</i>	Height	Longest Ray <i>if available</i>	Sketch of Crater <i>and comments (note diameter and depth)</i>

Exploring Meteorite Mysteries Lesson 7 — Crater Hunters

Objectives

Students will:

- observe impact craters on Earth and other solar system bodies.
- discuss geologic forces that have removed most of the evidence of the impacts on Earth.
- locate impact craters using longitude and latitude.
- search maps for potential impact sites.
- create a field work plan to investigate possible craters.

Background

Impact craters are geologic structures formed when a meteorite, asteroid or comet smashes into a planet or other solid body. All the terrestrial planets and satellites have been bombarded throughout their history. To us the most obvious examples of these impacts are the craters on the Moon. If the Moon is visible, craters are visible. You can only see the very large craters or basins with the naked eye. Lunar craters were not described until after Galileo used one of the first telescopes to look at the Moon. Modern binoculars help to make the craters on the Moon very obvious.

On the Earth, dynamic geologic forces have erased most of the evidence of its impact history. Weathering, erosion, deposition, volcanism, and tectonic activity have left only a small number of impacts identifiable. Approximately 140 terrestrial impact craters have been identified. These impact craters range from about 1 to over 200 kilometers in diameter and from recent to about two billion years in age.



*“Where
do they
come
from?”*

About This Lesson

After viewing slides of craters on other planets, the Moon, and Earth, students will locate impact craters on Earth using longitude and latitude and various maps. Students will locate potential sites of impacts, and plan the necessary research to verify their observations.

Vocabulary

impact crater, longitude, latitude, weathering, erosion, deposition, volcanism, tectonic, terrain, geophysical, ejecta, tektites, vaporize

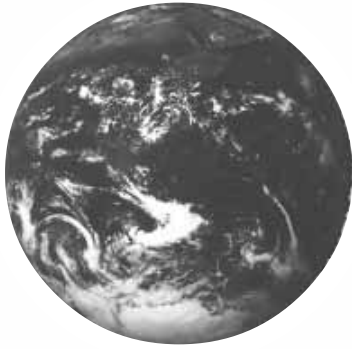

About This Activity

Part 1 - Students look at other bodies in the solar system to see that there has been a history of impacts in the entire inner solar system. Focusing on Earth, students discover that there are not many obvious craters. They locate craters on a map using longitude and latitude.

Part 2 - Without seeing pictures of the craters, students describe the craters using name, age, size, terrain, etc. The crater photographs are then shown to allow comparison with the students' descriptions of the craters.

Materials for Activity A

- slide projector and screen
- Slide Set, Impact Craters
- maps of North America or the world with longitude and latitude designated (pg. 7.4)
- Craters on Earth Data Chart (pg. 7.3, one per group or transparency)
- pen/ pencil
- Student Sheet for Activity A, Part 2 (pg. 7.5, one per student)

Lesson 7 — Crater Hunters

Activity A: “Where Are the Craters on Earth?”

Procedure

Advanced Preparation

1. Gather materials.
2. Read lesson background.
3. Review slides.

Classroom Procedure - Part 1

1. Show slides of Mercury, Venus, Moon, Mars.
2. Discuss how these bodies are alike and how they are different, focusing on cratering.
3. Ask “Where are the craters on Earth?” Show slide of Meteor Crater only.
4. Each student (or pair of students) is given a map of North America or the world.
5. Hand out (or put on overhead) the Craters on Earth Data Chart and designate the impact craters to be used (teacher may limit the number to be plotted).
6. Students plot designated craters using the longitude and latitude data, varying dot size according to crater diameter.
7. If Part 2 will not be completed, the final slides of Earth impact craters may be shown at this time.

Classroom Procedure - Part 2

In this advanced activity students consider geologic processes like faulting, weathering, and glacial activity.

1. Distribute Student Sheets.
2. Based on the age, size, name, and terrain, students write a description or make a sketch of what they think the crater shapes would look like.
3. Show the slides of the craters and have students describe craters again and compare to the previous descriptions.

Questions

1. Where are the craters on Earth?
2. What happened to the craters on Earth?
3. What are some differences between Moon craters and Earth craters?
4. Compare several Earth craters. How are they alike and different?

Craters on Earth Data Chart

Activity A, Part 1 “Where Are the Craters on Earth?”

Crater	Latitude	Longitude	Diameter (km)	Age (yr)
Meteor Crater, Arizona	35°N	111°W	1.2	50,000
*Manicouagan, Canada	51°N	69°W	70-100	212 million
Middlesboro, Kentucky	37°N	83°W	6	< 300 million
*Clearwater Lakes, Canada	56°00'N 56°15'N	74°07'W 74°30'W	22 32	290 million 290 million
Pilot Lake, Canada	60°N	111°W	6	440 million
Chicxulub, Mexico	23°N	90°W	200	65 million
Sierra Madera, Texas	31°N	103°W	13	100 million
Vredefort, South Africa	27°S	28°E	140	1.97 billion
Sikhote Alin, Russia	46°N	135°E	breakup	46 years
Ramgarh, India	25°N	77°E	5.5	unknown
*Spider, Australia	17°S	126°E	13	< 600 million
Grover Bluff, Wisconsin	43°N	90°E	6	< 500 million
Red Wing Creek, N. Dakota	48°N	104°W	9	200 Million
Odessa, Texas	32°N	102°W	0.2	<50,000
Kentland, Indiana	41°N	87°W	13	< 300 million
Manson, Iowa	43°N	95°W	3	65 million ??
Wells Creek, Tennessee	36°N	88°W	14	200 million

*Craters used in Activity A - Part 2

Crater Hunters Map

Activity A, Part 1 “Where Are the Craters on Earth?”

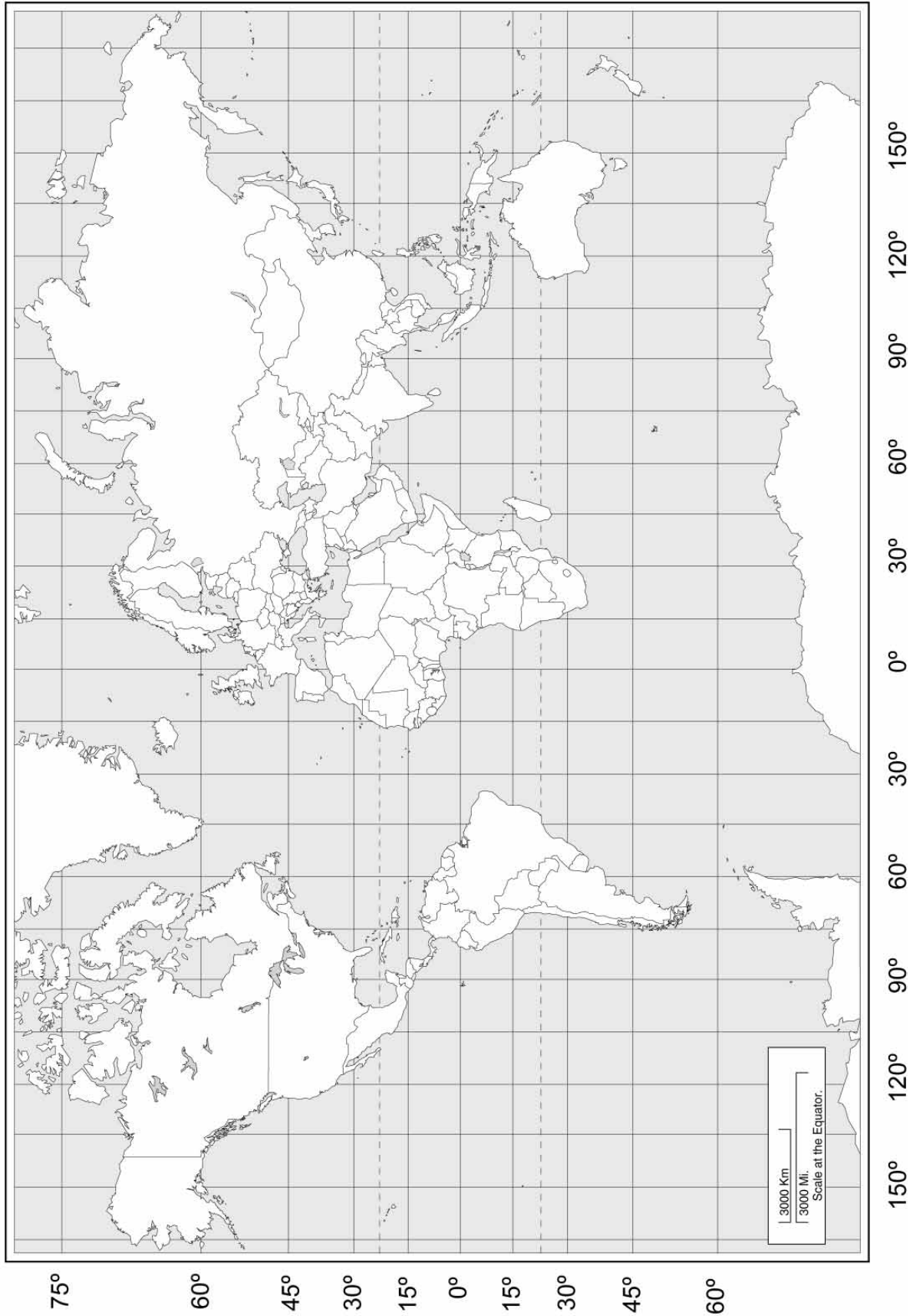

Student Sheet: Activity A

Activity A, Part 2 “Where Are the Craters on Earth?”

Procedure

1. Use a detailed physical map or atlas to locate the craters listed below; note important information on the chart.
2. Fill in a description of the surrounding terrain, especially consider the geology of the area, etc.
3. Considering all the information on the chart, write a description of what you think the craters look like.
4. View the pictures of the craters and write your second descriptions based on the pictures.
5. Compare the descriptions.

Crater	Location and Terrain	Description <i>(based on info)</i>	Description <i>(based on picture)</i>
<u>Spider Crater</u> Size 13 km dia. Age < 600 million yr.			
<u>Manicouagan</u> Size 70-100 km dia. Age 212 million yr.			
<u>Clearwater Lakes</u> Size 22 km and 32 km diameter Age 240 million yr.			

Longitude and Latitude for each crater can be found on Craters on Earth Data chart page 7.3.

Student Background: Activity B

Scientists perform extensive field and laboratory research before they are able to verify that a geologic feature is an impact site. Ideally the scientists are looking for round structures, however geologic forces may have distorted the crater shape through faulting or other movement associated with plate tectonics. Ice, water, and wind, through weathering and erosion processes, have caused great changes in craters. Some craters have been filled with water, or completely covered by soil or water, and have no surface evidence. They may initially be identified by remote testing of materials below the Earth's surface (geophysical studies).

Some of the clues that help scientists identify large impact sites are found in the physical condition of the structure. In addition to the crater's round shape, they look for layers of rock that have been turned over at the edge of the crater. A large uplift or mountain at the center is also common in impact craters. Highly fractured rocks are usually found at impact sites but they could be interpreted as being associated with other non-impact geologic processes. However, scientists find shatter cones, which are highly shocked rocks with distinct structures, only at areas stressed by huge impacts. Investigations usually identify large amounts of excavated material deposited around and in the craters. This material is called ejecta and may form thick layers of breccia, a mixed broken rock material. To verify the location and origin of these deposits requires extensive research, including drilling. Sometimes a large volume of impact melted rock is found in and around the craters. Some melted rock is frequently thrown far from the impact. These small glassy masses, which were aerodynamically shaped when they were molten, are called tektites. Very small ones are microtektites. They are very good indicators of large impacts.

Another way to get important information about an impact is from chemistry. The impact-melted rock sometimes contains melted meteorites. By careful laboratory research, scientists can detect very small amounts of rare elements that are more abundant in meteorites. These chemical signatures are very important in meteorite research. To find a meteorite sample would be the best discovery! Unfortunately this does not happen frequently. Meteorites may completely vaporize during the impact process, or they may be removed by erosion.

Early geologists misinterpreted some impact craters. Scientists reported Meteor Crater in Arizona as a volcanic crater. The Chicxulub site on the Yucatan peninsula was also wrongly reported. Early oil explorers misinterpreted extensive deposits around the Chicxulub area. Scientists now know that the material is ejecta from a huge impact and not of volcanic origin.

Considering the geologically active crust that erases craters, and all the research necessary to verify the origin of impact craters, it is not surprising that only around 140 have been identified so far. But it is likely that more will be found.

Lesson 7 — Crater Hunters

Activity B: Crater Hunters

Objectives

Students will:

- develop criteria for identifying craters on Earth.
- search maps for potential impact sites.
- create a fieldwork plan to investigate possible craters.

Background

See Student Background (pg. 7.6), also see background information in Lesson 16, pg. 16.2.

Procedure

Advanced Preparation

1. Gather materials.
2. Read background information.
3. Prepare sample crater if desired.



Classroom Procedure

1. Read and discuss background information. Review observations made in Part A of this lesson. Re-show slides if desired. Brainstorm an example crater and investigation if necessary.
2. Divide class into teams of two to four students.
3. Assign each team a different map area to observe, looking for any feature that might be the site of an impact. Allow students to be very creative in choosing the possible sites. Specific sites are not important. They are likely to choose obviously round structures such as lakes in Canada, Hudson Bay, the Gulf of Mexico, the Aral Sea in Uzbekistan (former Soviet Union), Lake Okeechobee in Florida, and Lake Victoria in Africa.
4. Students plan geologic field investigations and laboratory tests that might be done to verify that their designated crater is or is not an impact site. Report in outline form or see the proposal idea below.
5. Students write a short “proposal” asking for support money to conduct their research. They will need to explain and justify the planned research. Consider time, travel, personnel, laboratory expenses, and data gathering.

About This Activity

In teams students view physiographic maps of North America or another part of the world. They try to find a possible impact site based on circular shape and other features observed in the slides of impact craters on Earth. The teams will then develop a plan to do field research, listing the data they could collect and the tasks they could perform to help them verify if the formation is an impact site.

Materials for Activity B

- Student Background (pg. 7.6)
- large physical maps of any region of the world, one per team
- paper and pencil

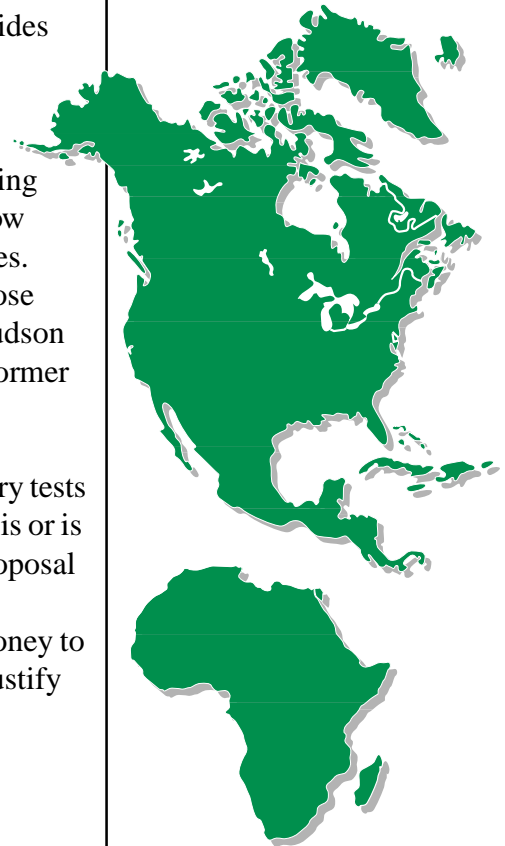

Teacher notes for field investigations

Ask students “What would you look for at the site to help prove that you have found the remnants of an impact?” Possible answers might be:

- look for meteorites
- map the geologic formations looking for: a basin shape, overturned rim layers, possible uplift in the central crater region, multiple ring structures (see Lesson 6)
- look for minerals changed by impact shocks
- look for melted rocks
- test deposits associated with the debris from the crater, looking for elements that are much more abundant in meteorites (i.e., Iridium).

Exploring Meteorite Mysteries

Lesson 8 — Edible Rocks

“What are they?”

Objectives

Students will:

- observe and describe physical characteristics of an edible sample in preparation for describing rock or meteorite samples.
- work cooperatively in a team setting.
- use communication skills, both oral and written.

Materials

- prepared edible samples (*see attached list, pg. 8.3 and recipes, pg. 8.4*)
- small plastic bags for samples knife
- “Field Note” Sample Descriptions of candy bars, enlarged and cut into numbered segments (*pgs. 8.7-8.10*).

Note: If included recipes are not used, then the descriptions may need to be revised by the classroom teacher to more accurately describe the actual samples.

- Student Procedure (*pg. 8.5, one sheet per team of two*)
- colored pencils for each team
- pen or pencil



Cut surface of “edible rock.”

Procedure

Advanced Preparation

1. Prepare samples. Simple recipes are included for some samples. The first six listed on the answer key are especially important since they closely represent meteorite characteristics that will be taught in other lessons. The other samples on the list are good for meeting the objectives of this activity and offer more variety. Use as many as needed, add a few extras to complicate the exercise.

About This Lesson

This lesson has been designed as a comfortable introduction to describing meteorites. It helps students become better observers by making a connection between the familiar (candy bars) and the unfamiliar (meteorites). Edible “rocks” are used in a scientific context, showing students the importance of observation, teamwork and communication skills. In everyday terms, students draw and describe the food. Students will pair their observations with short descriptions that are in geologic “Field Note” style. As the teacher and class review, appropriate geologic terminology may be substituted by the teacher and subsequently embraced by even very young students. The last part of this activity allows the student to describe rock specimens before they move to meteorite samples in the Meteorite Sample Disk.

Note: Objectives and a formal vocabulary introduction should not be discussed until the end of the activity.

- Cut the samples so that a flat interior surface is exposed.
Reserve part or most of each sample — to be eaten by the students as a reward.
- Place each sample for student teams in a small plastic bag. Each team of two students will have one bag containing one sample.
- Copy Student Procedure sheets, one for each team of two.
- Cut enlarged “Field Note” Sample Descriptions into numbered segments. Descriptions are written the way a scientist might take notes in a field record book.
- Arrange one set of prepared “Field Note” descriptions on a table(s) so that students may easily read and reach each of them (numbered sequence is not important).
- Have answer key available for teacher.
- Have a variety of rock samples available (students may bring their own samples).

Classroom Procedure

- Distribute sample and procedure sheet to each team. Allow student teams to choose sample if possible.

Note: Content vocabulary should not be expected initially. The processes of observing and recording should be kept simple.

- Explain that each team is responsible for describing and sketching its sample. Encourage students to describe their observations using familiar vocabulary; however, **use no food terms**. Example: The outer layer is a thin coat of light brown material containing cream or tan colored round chunks (i.e., chocolate candy bar coating that contains peanuts). Student descriptions need not be exactly like the provided descriptions. In fact their descriptions may be far more detailed than the short descriptions provided, which are in geologic “Field Note” form.

- Emphasize that working together is important.

- When sketch and description of sample are complete, students take them, along with their sample, and pair them with the prepared written descriptions. Emphasize that their observations will not be exactly like the “Field Notes.” They will likely try several matches before they have the accurate pairing.

Throughout this step, the teacher will verify correct pairs. Expect questions like, “Is number one peanut brittle?”. When they have found the “Field Note” that describes their sample, students should place their sketch, description, and sample next to the correct “Field Note” description. Reward the



Rice cereal treats — (meteorite breccia).

students by allowing them to eat the reserved part of the candy or other treat. If students have difficulty finding the description of their candy bar then the teacher should encourage them to interact with other groups for help. This step of the lesson will likely become a slightly noisy, cooperative process. As students find a match between “Field Note” descriptions and candy bars, some definitions may be supplied if necessary, i.e. “Platy means flaky flat material.”

Time: Classroom Steps 1 thru 4 take 25-30 minutes total.

5. When all students have successfully matched their samples, each team may describe its sample to the class. The class should have access to the sample and the prepared written description during this sharing. Sketches may be displayed.
6. Conduct a discussion that includes the following points which emphasize basic skills needed to be good scientists:
 - The students made detailed **observations** of a sample.
 - The task was accomplished by using **teamwork**.
 - Although the student’s descriptions differed from those provided and each team had a different style, the skills and processes used to observe and record the data were the same for each group.
 - The students **communicated** their observations and then shared the findings **verbally** and in **writing**.
7. During the discussion, the teacher may expand and help define the meteorite and geologic vocabulary in context and encourage students to apply it to their own samples as they progress to the next step. Pay particular attention to vocabulary for the first six samples that use some words especially pertinent to meteorites.
8. Have students test their observation skills again by sketching and describing real rocks.

Vocabulary

texture, density, matrix, breccia, phases, fusion crust, chondrules, inclusions, vesicles, bleb, friable, platy, porous, unfractured, unconsolidated, regolith

Extension

Using Meteorite Sample Disk or photographs of meteorites in disk, students repeat the same procedure of observing and recording (or see Lesson 9—Meteorite Sleuths!).

Teacher Key

- | | |
|---|---------------------------|
| 1. Peanut Brittle (<i>chondrites</i>) | 13. Skor™ |
| 2. Rocky Road (<i>chondrites</i>) | 14. Rolo™ |
| 3. Chocolate (<i>iron without fusion crust</i>) | 15. Kit Kat™ |
| 4. 3 Musketeers™ (<i>achondrite with fusion crust</i>) | 16. Symphony™ |
| 5. Rice Cereal Treats (<i>meteorite regolith breccia</i>) | 17. M & M™ |
| 6. Chocolate brownie (<i>carbonaceous chondrites</i>) | 18. Nestle Crunch™ |
| 7. Snickers™ | 19. Whatchamacallit™ |
| 8. Milky Way™ | 20. Mounds™ |
| 9. “Bar None”™ | 21. P.B. Max™ |
| 10. Hershey Bar™ | 22. Mr. Goodbar™ |
| 11. Twix™ | 23. Hershey with Almonds™ |
| 12. Butterfinger™ | |

Recipes

for samples not easily available commercially.

Note: Recipes are for a larger quantity than required for the lesson.

Rocky Road (#2 Edible Rock)

170 g (6 oz.) semi-sweet chocolate pieces (melted)

120 g (2 cups) mini-marshmallows

- butter loaf pan or folded foil
- pour about half of melted chocolate into pan
- pour marshmallows into pan and mix so they are coated with chocolate
- pour remaining chocolate over the marshmallows and spread flat
- refrigerate until cold
- cut a cube so vertical surface is exposed

Solid Chocolate (#3 Edible Rock)

use any thick chunk of solid chocolate

Chocolate Brownies (#6 Edible Rock)

- use any recipe for dark chocolate brownies or a box mix
- add large chunks of semi-sweet baking chocolate or solid chocolate candy (add enough so that the solid candy will be exposed on a cut surface)
- bake and cool completely
- cut, exposing some brownie and some solid chocolate; this surface will be described
- to form the breccia texture, cut the cube in several places, then reassemble the cube in a jumbled manor, incorporating one or two jelly beans and or other edible chunks
- allow the sample to harden so that a good surface may be cut
- cut the sample so that chunks and various chocolate lines are exposed
- students will describe the cut surface

Regolith Breccia Simulant (# 5 Edible Rock)

(Marshmallow cereal treats)

240 g (1/2 cup) butter or margarine (melted)

300 g (10-11 oz.) mini-marshmallows

200 g (8 cups) crispy rice cereal

170 g (6 oz.) chocolate semi-sweet pieces (melted)

1 or 2 jelly beans, chocolate chunks,

or other large edible lumps

- butter a deep rectangular baking pan
- melt butter in microwave or in large pan on the stove
- add marshmallows and melt (2 min. in microwave)
- stir until smooth
- pour over cereal and stir to coat all cereal,
- press half of mixture into deep buttered pan
- spread cereal layer with melted chocolate
- press remaining mixture on top of the chocolate
- allow cookie to cool enough to cut but not until completely hardened (should still be partly moldable)
- cut one cube about 5 cm square, then cut again once or twice
- embed one or two jelly beans in part of the cut cube
- mold cut pieces together again to form a “breccia”
- allow to harden
- recut to expose interior and jelly bean

Student Procedure

Materials - Per Two Students

- sample “rock”
- this procedure sheet
- pen or pencil
- map pencils

Procedure

1. With your partner, choose **one** sample to observe.
2. Carefully observe the sample. You may remove the sample from the bag, but handle it carefully and **do not taste**.
3. Make a large, detailed sketch of the sample. The sketch should show the **interior** cut surface that is flat and any important details of the exterior. You may use the back of this paper for your sketch.
4. Write 2-3 sentences describing the physical characteristics of the **cut surface** of the sample. **Do not use any food terms**. For example, do not use the word chocolate. Make your description as clear and complete as you possibly can.
5. When you have completed Step 4 take your description, sketch and sample to the table where the “Field Note” descriptions of the food samples are located. Find the description that fits your sample. Check with your teacher to see if you identified the correct match. You will likely try several of the descriptions before you find the one that describes your sample. You may get help from others. Try checking with the teacher or a dictionary for unfamiliar words.
6. Place your description, sketch, and sample beside the “Field Note” description for your sample.
7. Your effort will be rewarded with another part of the sample to eat.

“Field Note” Sample Descriptions

These food descriptions are in geologic “Field Note” style. Therefore, they may be short and sometimes cryptic. Use of geologic terms will encourage students to stretch their minds.

1. Sample is a thin layer. There is a golden matrix surrounding tan rounded or broken inclusions. The inclusions have a reddish brown rim or crust.
2. Sample consists mainly of white, soft rounded to angular blebs completely surrounded by a uniform dark brown matrix.
3. Sample is a solid dark brown dense mass with no obvious fusion crust.
4. Sample has a homogeneous light brown interior with a few small vesicles. The exterior looks like a fairly regular, dark brown fusion crust with some patterning.
5. Sample appears to have been distorted. The dominant phase is made of rounded light tan fragments containing many void spaces. A dark brown thin layer fills spaces between some rounded fragments. There are some large foreign inclusions.

6. Sample is totally dark brown with two phases. The dominant phase is shiny and crumbly. The other phase is dense and slightly lighter in color. A light fusion crust appears on only one side.
7. **Outside:** Thin medium-brown layer with ripple-marks on the bottom
Inside: **Bottom** - (~1/3) flat dense buff layer
Top - (~2/3) pebbles consolidated in a fine grained tan matrix
8. **Outside:** Thin medium brown layer with wavy ripple marks on the bottom
Inside: **Bottom** - dense dark buff layer
Top - shiny, smooth, medium tan layer
9. **Outside:** Medium brown layer, thin on the bottom, the thicker top contains angular inclusions
Inside: Thin alternating horizontal layers of smooth dark brown and fragmented dark brown
10. Dense medium brown sample, flat on the bottom with three parallel ridges on top.

11. **Outside:** Thin medium brown layer with wavy ripples on the bottom
 Inside: **Bottom** - poorly consolidated light tan porous layer
 Top - shiny smooth medium tan layer
12. **Outside:** Thin medium brown layer
 Inside: Poorly consolidated, friable, shiny to dull golden platy fragments
13. **Outside:** Medium brown layer, very thin on bottom and side, thicker on top with large wavy ripples
 Inside: Thin dense layer of shiny light-golden unfractured material
14. **Outside:** Thin, medium brown, edges higher on outside of top, sides slanted
 Inside: Smooth material that is yellowish brown and sticky
15. Four segments of layered material.
- Outside:** Thin, medium brown
 Inside: Alternating light and medium colored material
16. Solid medium brown throughout, single dense layer with a valley or dip in the top.

17. Sample consists of unconsolidated pebbles with various colors and regular shape. Each individual pebble has a medium brown interior with a thin, hard colored shell.
18. Sample has a thin layer of dense brown material, containing very light inclusions at the bottom. The sample top has a depression in the middle with a ridge on each side.
19. Sample is a rectangular layer of rounded light pebbles surrounded by a thin coating of medium brown. Some yellowish brown sticky material is above the pebbles.
20. Sample interior consists of white, moist-looking fragments. These are surrounded by a dark brown exterior layer.
21. Irregular sample.

Outside: Bumpy medium brown
Inside: Yellow brown solid material resting on light tan fragments, some large tan fragments are found near the top
22. **Outside:** Dense layer of medium brown with a dip in the top
Inside: Light tan pebbles that have settled to the bottom
23. Dense sample of medium brown material, rounded on the top and flat on the bottom, with a few light brown pebble inclusions.

Exploring Meteorite Mysteries

Lesson 9 — Meteorite Sleuths!

Objectives

Students will:

- simulate techniques used by scientists.
- develop skills in acquiring data through the senses.
- observe, examine, record, and sketch data.
- use magnifying glasses, microscopes, and balances.
- experience conceptual application.

Background

See background information on Student Sheet, Station 4, page 9.7.

Lesson Information

Scientists use a variety of methods to classify materials and objects. Specific technologies and techniques are used in the classification of meteorites. The Meteorite Sample Disk (or photographs if the Meteorite Sample Disk is not available) is the focal point for these activities presented in a laboratory format. The laboratory activity is broken into four sections that simulate meteorite identification methods. A rotation lab is suggested with the Meteorite Sample Disk displayed at a central location for periodic comparisons. Teams of students will work at numbered stations, taking lab notes in appropriate sections on a prepared laboratory worksheet. Rotations will be ordered numerically; however, no specific order is necessary in completing the lab. Since all portions of the lab are broken down according to stations, teachers may prepare for and include only those portions desired.

Note: Station numbers should be clearly identified to facilitate orderly rotations. Additional duplicate stations may be set up to allow for more than 4 groups per class.

Upon completion of all rotations a “wrap-up” session in which lab results are reviewed and discussed **in order**, will clarify student understanding. The students have made observations from general macroscopic inspections to microscopic details — like the game “20 Questions” in which someone is asked to identify an unknown life form via 20 “yes/no” questions. The winner invariably goes from general to specific questions.

“What are they?”

About This Lesson

The activities in this lesson focus on observation and examination skills. A Meteorite Sample Disk (or photos) will be at the center of four laboratory stations. Students will use several degrees of magnification to research meteorites in the Meteorite Sample Disk and other materials. Discussing the sequence will help them understand how scientists approach meteorite research and classification.



Vocabulary

texture, chondrite, achondrite, stony-iron, iron, mass, density, volume, specimen, classification, hypothesis, cross section, carbonaceous chondrite



Materials

- Meteorite Sample Disk or photographs
- magnifier
- binocular reflected light microscope (*optional*)
- Student Sheet (*pgs. 9.5-9.8*)

About This Station

Students visually examine a rock specimen and record observations of color, texture, and shape. Measurements are taken and a sketch of the rock is made. The students proceed to the Meteorite Sample Disk display and record colors of each meteorite.

Materials for Station 1

- fist-sized rock
- graph paper (*2 cm x 2 cm blocks*)
- metric ruler
- pencil, and map pencils or crayons
- Student Sheet (*pg. 9.5*)

Lesson 9 — Meteorite Sleuths! Meteorite Sample Disk Display

Procedure

Advanced Preparation

1. Gather and assemble materials.
2. Review lesson information and Station 4 background.
3. Set up Meteorite Sample Disk or photos in central station.

Classroom Procedure

1. Divide class into 4 or more groups.
2. Distribute Student Sheets.

Station 1: Initial Inspection

Objectives

Students will:

- develop skills in acquiring data through the senses.
- measure, record, and sketch rock samples.

Procedure

Advanced Preparation

1. Place graph paper, rock, and ruler on lab table.

Classroom Procedure

1. Visually examine rock specimen.
2. Record observations related to color, texture, and shape of rock.
3. Measure rock and record measurements on Student Sheet.
4. Sketch rock to scale on grid provided.
5. Proceed to Meteorite Sample Disk display and record colors of each meteorite.

Station 2: How Dense Is Dense?

Procedure

Advanced Preparation

1. Place balance, gram masses (weights), container of marbles, and prepared index card (verifying equal volumes of all marbles) on lab table.
2. Consider steps 4 or 5 for upper grades or advanced students.

Classroom Procedure

1. Measure the mass of each type of marble.
2. Write a comparative statement using the words “mass” and “density” for each type of marble (density = mass/volume).
3. Proceed to Meteorite Sample Disk display and predict whether the iron or the achondrite has greater density.
4. **Optional:** Weigh equal volume (approximately) pieces of steel and basalt to compare to the iron and achondrite.
5. **Optional:** Look up the specific gravity of iron and the common rock forming minerals feldspar, and pyroxene found in achondrites. Use this information to help determine whether the iron or achondrite is more dense.

Station 3: Observation with Magnification

Procedure

Advanced Preparation

1. Place printed picture(s) and magnifiers on lab table.

Classroom Procedure

1. Examine picture(s) with the unaided eye.
2. Examine picture(s) with a magnifier.
3. Record your observations.
4. Proceed to Meteorite Sample Disk display and examine the stony-iron and the chondrite A with the unaided eye and a magnifier.
5. Record your observations on Student Sheet.

About This Station

Students will determine the mass of several marbles and hypothesize whether the iron or the achondrite has greater density.

Materials for Station 2

- beam balance
- metric masses (2 *small paper clips* = 1 gm)
- marbles and/or other objects of equal volume but different densities
- container for marbles
- index card showing diameters of the marbles to verify equal volumes of all marbles
- Student Sheet (pg. 9.6)



About This Station

Students examine printed images and the Meteorite Sample Disk with and without magnification.

Materials for Station 3

- full-color printed picture(s) — newspaper, magazine
- magnifier
- Student Sheet (pgs. 9.6-9.7)

Station 4: Journey to the Center of the Fruit

About This Station

Students experience the progression from general to more specific observations.

Materials for Station 4

- two of the same type of easy-to-slice fresh fruits that are optically interesting (*example: kiwis, * apples, oranges, tomatoes, etc.*)
- sharp knife
- cutting board
- magnifier
- binocular microscope
- clean slides and cover slips
- paper towels
- 3 index cards labeled “1,” “2,” and “3”
- Student Sheet (pgs. 9.7-9.8)

* *Kiwi fruit is similar to most meteorites in that its outer surface is so different from the interior. The flesh of an apple is similar to most meteorites in that, under magnification (even with just a hand lens), the appearance is vastly different from that seen with the naked eye. The outer perimeter of the peel of an orange looks similar to fusion crust when under the microscope. The flesh of a tomato appears to have chondrules when magnified.*

Objective

Students will:

- experience conceptual application.

Procedure

Advanced Preparation

1. Cut one piece of fruit into halves.
2. Cut one medium slice from one half so that a good cross section is revealed.
3. Cut one very thin cross section slice from the remaining half and place on slide on microscope stage.
4. Adjust microscope for viewing. Make thinner slice if necessary for microscopic viewing.
5. Place fruits and equipment on the lab table in the following order:
 - whole fruit (labeled: #1 whole fruit),
 - thick slice from half of fruit (labeled: #2 cross section) with magnifier,
 - thin slice mounted on microscope (labeled: #3 thin section).
6. Remaining fruit will not be needed in this lab exercise.

Note: If microscope is not available, a magnifying glass or hand lens is adequate for meeting the lab objectives.

Classroom Procedure

1. Read background information on Student Sheet (pg. 9.7).
2. Observe all samples in order and record observations, **not** what you already know.
3. View the meteorites using a microscope if available.
4. Write a short paragraph that describes the relationship between your lab experience and the information on the Student Sheet.

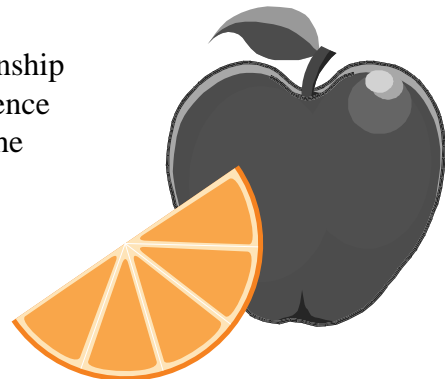

Station 2: How Dense Is Dense?

Procedure

1. Measure the mass of each type of marble.
Mass of first marble type: ___ gm Mass of second marble type: ___ gm
2. Write a comparative statement using the words “mass” and “density” for each type of marble (density = mass/volume).
3. Proceed to Meteorite Sample Disk display and predict whether the iron or the achondrite has greater density. (Circle one) Iron Achondrite
4. What data would be necessary to support your prediction?
5. How do density and mass relate to identification of meteorites?

Station 3: Observation with Magnification

Procedure

1. Examine the picture both with the unaided eye and the magnifier. Describe or sketch your observations. Complete the sentences below using details of your observation.

With the unaided eye the picture is...

Viewed through the magnifier the picture is...

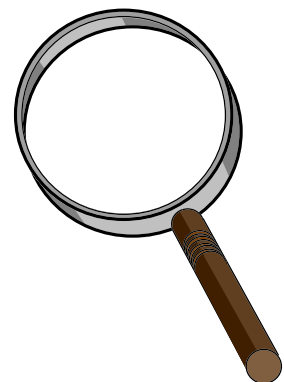

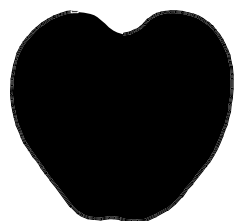

Procedure

1. Observe all samples in order and record observations. Do **not** record just what you already know.

#1. Whole Fruit

#2. Fruit Cross Section

#3. Fruit Thin Section

2. If a microscope is available at the Meteorite Sample Disk display, view all the meteorites and list one where you see much more detail in the microscope than you did with your unaided eye. Sketch and describe the meteorite’s detail you see in the microscope.

meteorite sample name

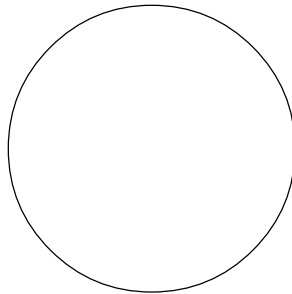

3. Write a short paragraph that describes the relationship between your lab experience and the background information.

4. What questions must be answered first in a scientific investigation?

5. What is the progression scientists follow in examining a specimen?

“How
did they
form?”

Objectives

Students will:

- experiment with simulations that illustrate how chondrites and asteroids formed in the early solar system.
- observe and describe the meteorites in the Meteorite Sample Disk.

Background

Chondrites are the most primitive type of rock available for study. They are 4.5 billion years old, as old as the solar system. Their compositions are similar to the heavier elements found in the Sun (not including the abundant H and He gases). Chondrites are made up of chondrules (spherical balls of rock), metal, and a fine matrix that holds them together. Chondrules are considered the building blocks of the planets. Chondrites have many variations, due partly to differences in the chondrules. Some of the differences are in the number, size, shape, and mineral content of the chondrules. Chondrites have various amounts of metal too. Metamorphism causes some of the variations in chondrules. One of the chondrites in the Meteorite Sample Disk is metal-rich and metamorphic, another is metal-poor and has distinct chondrules. The third chondrite is carbonaceous. This special type of meteorite contains water and carbon and some organic compounds (amino acids) that are the building blocks of life. They do not contain living creatures or fossil material. (See Lesson 12)

Chondrites provide our best information on the earliest history of the solar system. Scientists think that chondrites formed by condensation and accretion in the solar nebula, the disk of gas and dust that rotated in a plane around the early Sun. Dust particles condensed from the gas and accreted (came together) into larger and larger bodies: chondrules, then small rocks, and then asteroids and planets. The forces that hold particles together include static electricity, gravity, and magnetism. Some asteroids were large enough to be hot inside thus causing some metamorphism. Most meteorites are formed by the breakup of asteroids.

See additional information in the Teacher’s Guide, pages 16-17.

About This Lesson

In Activity A students will observe and describe chondrite meteorites.

In Activity B they will experiment with balloons and static electricity to illustrate the theories about how dust particles collected into larger clusters.

In Activity C students will manipulate magnetic marbles and steel balls to dramatically illustrate the accretion of chondritic material into larger bodies like planets and asteroids.

NOTE: The use of magnets in Activity C is intended to simulate all three forces. **Do not** let students equate magnetism, a minor force, with the major forces, gravity and electrostatic charge.

Vocabulary

chondrule, chondrite, sphere, matrix, solar nebula, condense, accrete, accretion, metamorphism, organic, static electricity, gravity, magnetism



About This Activity

Students will observe and describe chondrite meteorites.

Materials for Activity A

- Meteorite Sample Disk
- Magnifier
- Slide Set, Classification and Formation
- Slide projector
- Student Sheet (pg. 10.5, one per student)

About This Activity

Students will experiment with balloons and static electricity to illustrate the theories about how dust particles collected into larger clusters.

Materials for Activity B **Per Group of Students**

- 1 small balloon, inflated (extras to allow for popped balloons)
- 1 handful of small (1-2 mm) styrofoam pellets (from crushed packing material or a bean bag chair)
- 1 22 cm glass pan
- Student Sheet (pgs. 10.5-10.6, one per student)

Lesson 10 — Building Blocks of Planets

Activity A: Chondrites

Objective

Students will:

- observe and describe chondrite meteorites.

Procedure

Advanced Preparation

1. Assemble materials and place Meteorite Sample Disk in an easily accessible location.
2. Preview slide set, slide narrative and the meteorite descriptions in the Meteorite ABC's Fact Sheet, pages 29-30.

Classroom Procedure

1. Show meteorite classification and formation slide set and discuss.
2. Examine the three chondrite samples in the Meteorite Sample Disk or photographs. Use magnifier.
3. Sketch and describe each sample on Student Sheet.
4. Complete questions. Reserve discussion until end of activity.

Activity B: ZAP! Electrostatic Small Particle Accretion

Objectives

Students will:

- experiment with static electricity to illustrate one of the forces in the early solar nebula.
- observe, record, and relate their observations to physical processes.

Procedure

Advanced Preparation

1. Read Teacher's Guide, pages 16-17.
2. Blow up each balloon just before class time.

Classroom Procedure

1. Students place styrofoam balls in glass pan.
2. Student rubs the balloon in one direction on hair to create electrostatic field.
3. Student places the balloon in dish and observes the activity of the styrofoam. Record each step and observations.
4. Try experiment again and rub the balloon both ways on your hair. Record observations.
5. Discuss questions and relate experiments to concepts.



Lesson 10 — Building Blocks of Planets

Activity C: CRUNCH! Accretion of Chondrules and Chondrites

Objectives

Students will:

- manipulate materials to illustrate planetary accretion.
- observe, record, and relate their observations to physical processes.

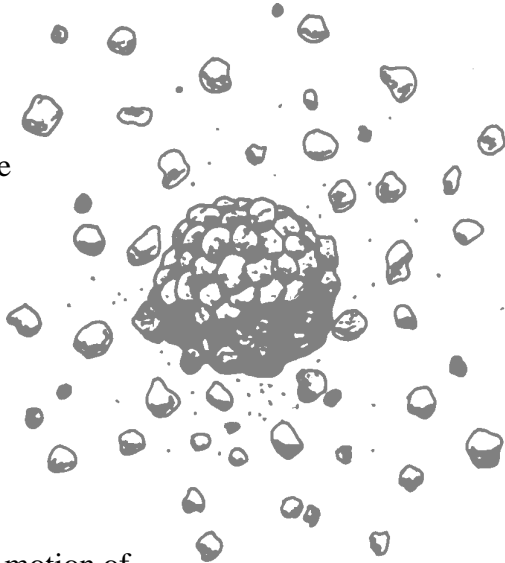

Procedure

Advanced Preparation

1. Practice the circular motion of the pie pan and the addition of each type of ball.
2. This simulation may be done on an overhead if a demonstration is necessary.

Classroom Procedure

1. Divide class into groups of 3-5 students and assign individual tasks. One student holds the pan; one to three students add balls to the pan; one records observations and one or more reports findings. Teacher might quickly demonstrate the procedure for the small balls.
2. First student picks up the pan and practices orbital movement of the pan (slow circular pattern in only one direction).
3. Another student adds the small balls to the pan and the first student continues to rotate the pan until balls start separating and moving in a circular pattern. Observe the movement and clustering and record observations.
4. Another student adds medium sized balls, one at a time while first student continues rotating the pan. Experiment with adding different numbers of these balls. Observe the movement and clustering of the small balls and record observations.
5. Another student adds one magnetic marble and quickly adds the other one. First student continues to rotate the pan. Observe the movement and clustering around the marbles and record observations.

About This Activity

Students will manipulate magnetic marbles and steel balls to dramatically illustrate the accretion of chondritic material into larger bodies like planets and asteroids.

NOTE: The use of magnets in Activity C is intended to simulate all three forces. **Do not** let students equate magnetism, a minor force, with the major forces, gravity and electrostatic charge.

Materials for Activity C

Per Group of Students

- 50-100 small steel balls (4.5 mm steel BBs work well and a mixture of copper-and zinc-plated BBs provides color contrast)
- 5 medium steel balls (1 cm or 3/8" steel hunting shot about double the diameter of BBs)
- 2 magnetic marbles (found in museum gift shops, and gift or science catalogs)
- round glass or aluminum pie or cake pan (glass is best; flat bottom is essential; vertical-sided pans contain BBs better, but slant-sided pans produce more action)
- Student Sheet (pg. 10.6, one per student)

6. Have student groups share results with class. Conduct a class discussion of how this simulation illustrates the formation of meteorites and asteroids by accretion of dust in the solar nebula. Do not let students equate magnetism with gravity—the magnets allow a dramatic visual simulation only. Small balls represent dust, medium balls are chondrules, large balls are chondrites and clusters are asteroids.

Questions

1. What happened to the small balls when the pan was moved?
2. How did the medium balls interact with the small ones? Was the movement of the two sizes the same or different?
3. Was there an immediate reaction when the magnetic marbles were added? Did the reaction continue or change?
4. What did you notice about the small balls at the end of the activity?
5. How does this simulation relate to the accretion of meteorites in the early solar system?
6. **Extra:** Which way does our solar system rotate: clockwise or counter clockwise? (Draw the solar system on a thin sheet of paper and place an arrow to indicate that the solar system moves in a counterclockwise motion, as viewed from above. Now look through the other side of the paper and determine which direction of movement is indicated by the arrow —clockwise. **The rotation direction is relative to the viewing perspective!**)

Student Sheet: Activities A, B and C

Activity A: Chondrites

Carefully observe the three chondrites in the Meteorite Sample Disk. Describe and sketch them using the space below.

How do you think chondrites may have formed?

Activity B: ZAP! Electrostatic Particle Accretion

Procedure

1. Place styrofoam balls in glass pan.
2. Rub the balloon in one direction on hair to create electrostatic field.
3. Place the balloon in the dish and observe the activity of the styrofoam.
4. Try the experiment again and rub the balloon both ways on your hair.



In the space provided below record observations from each step of the procedure.

Questions

1. How did the balloon and styrofoam balls react when you first put them together?
2. Why does this reaction happen?

3. Why do you think the balloon reacts differently when you rub it both ways in your hair rather than when you rub it one way?
4. How could you relate this exercise to accretion in the solar nebula?

Activity C: Crunch! Accretion of Chondrules and Chondrites

Procedure:

1. Practice circular motion as demonstrated by the teacher. Continue until the simulation is complete. Predict what will happen as each set of balls is added.
2. Other students add small balls, continue rotation and observe.
3. Add medium steel balls (experiment with number of balls), continue rotation and observe.
4. Add two magnetic marbles at different spots, continue rotation and observe.

Questions

1. What happened to the small balls when the pan was moved?
2. How did the medium balls interact with the small ones? Was the movement of the two sizes of balls the same or different?
3. When the magnetic marble was added, what was the immediate reaction? Did the reaction continue or change?
4. What did you notice about the small balls at the end of the activity?
5. How does this simulation relate to the accretion of the meteorites in the early solar system? What does each type of ball represent? Why is this activity only a simulation? (*Hint: consider the major forces the marbles represent.*)

“How did they form?”

Objectives

Students will:

- observe and describe differentiated meteorite samples.
- conduct experiments to model the separation of light and heavy materials within a planetary body.
- relate meteorites to the core, mantle and crust of asteroids.
- model the break-up of a differentiated body to expose the interior layers.

Background

Achondrites are stony meteorites without chondrules or metal. Metal-rich meteorites include irons with little stony material and stony-irons which are part iron and part stone. Most of these meteorites are, like chondrites, 4.5 billion years old. However, their compositions are usually different from those of chondrites and different from the Sun. Thus, they are grouped together as differentiated meteorites. There are three of these differentiated meteorites in the Meteorite Sample Disk. One of the meteorites is an achondrite consisting mostly of two silicate minerals. It is a basalt similar to basalts existing on Earth. The second sample is a metal meteorite made of two types of iron/nickel crystals. The third sample is a stony-iron meteorite made of metal and a single silicate mineral, olivine. See Teacher’s Guide, pages 13-17, for more information.

Scientists think that these meteorites formed by differentiation in asteroids or other planetary bodies. Heat in the asteroid caused the body to melt. Heavy metal sank to the interior to form a core. Light silicate minerals floated to the surface to form the crust. Moderate density silicates crystallized in the mantle. Basalts can also form by incomplete melting in the mantle of a planetary body and rise to the surface as volcanic rocks.

Earth is differentiated into core, mantle and crust, but we cannot see the mantle or core. Researchers believe that those inner layers exist because differences in the internal structure of Earth have been measured using seismic waves. Scientists think that iron meteorites are from the cores of asteroids and some stony-iron meteorites are from the core-mantle

About This Lesson

In this lesson students will observe and describe differentiated samples in the Meteorite Sample Disk (or photographs). They will conduct an experiment using gelatin and food that illustrates planetary differentiation. Hard boiled eggs model the break-up of differentiated planetary bodies.

Vocabulary

achondrite, iron, stony iron, asteroid, metal, silicate, crystallization, differentiation, crust, mantle, core, basalt, density

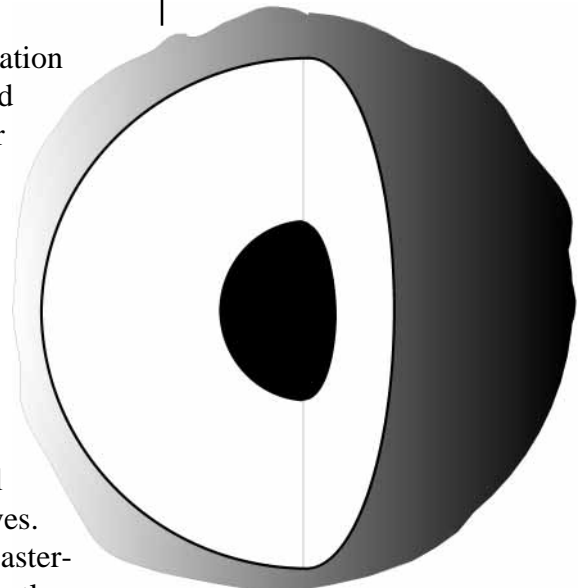

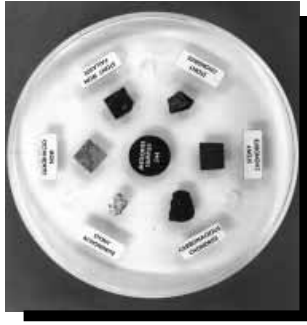

About This Activity

Students will observe and describe differentiated meteorites in the Meteorite Sample Disk or in the photographs.

Materials for Activity A

- Meteorite Sample Disk or photographs
- Student Sheet (*pg. 11.5*)
- magnifier
- binocular microscope (*optional*)
- Slide Set, Classification and Formation
- projector

boundary. Achondrites may represent the crustal material of asteroids. In order for the deep-seated rocks from the core and mantle to be exposed, impacts in the asteroid belt must break up the parent asteroids.

Lesson 11 — Changes Inside Planets

Activity A: Differentiated Meteorites

Objective

Students will:

- observe and describe differentiated meteorites.

Procedure

Advanced Preparation

1. Assemble materials.
2. Place Meteorite Sample Disk or photographs in an easily accessible location so students may view and draw samples.
3. Preview slide set, slide narrative, and descriptions of meteorites in the Meteorite ABC's Fact Sheet, pages 29-30.

Classroom Procedure

1. Show slide set and discuss meteorite classification.
2. Examine achondrite, stony-iron, and iron in Meteorite Sample Disk or photographs. Use magnifier or microscope.
3. On the Student Sheet, sketch and describe each of the samples listed above.
4. Complete the questions on the Student Sheet.
5. Reserve discussion until after Activity B.

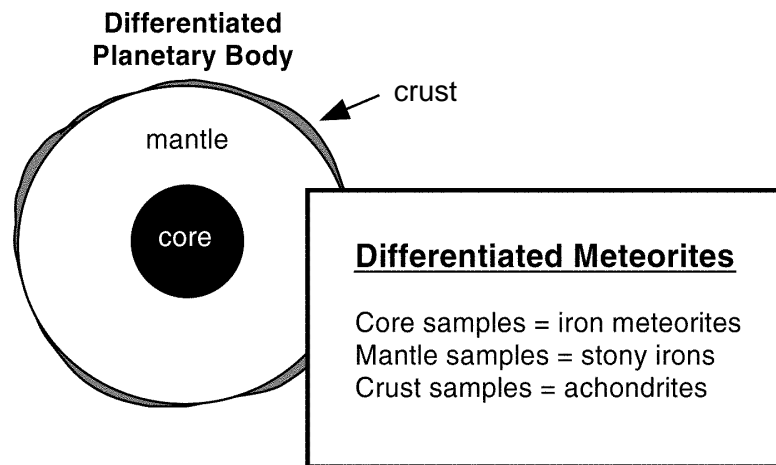

Lesson 11 — Changes Inside Planets

Activity B: Food Differentiation

Objectives

Students will:

- conduct experiments to model the separation of light and heavy materials within a planetary body.
- relate meteorites to the core, mantle, and crust of asteroids.

Procedure

Advanced Preparation (See options below.)

1. Read classroom procedure and options to determine best method for class.
2. Assemble materials. Either teacher will provide necessary foods for experiments or assign students to bring items. Be sure to provide several items that float and several that sink. Use items that may be eaten to minimize waste, and increase enjoyment.

Option 1. Working in groups each student makes predictions and experiments with their own cup of food and gelatin. See Classroom Procedure.

Option 2. Prior to class make a model(s) for students to use. The predictions and observations may still be made by the students prior to viewing the model. Student Sheet questions, drawings and discussions may be used to complete the activity.

Option 3. Conduct experiment by having students make predictions and record information and observations. Then make only one or possibly two large samples as a demonstration for the entire class. Continue with Student Sheet questions and discussion.

Classroom Procedure

1. Divide class into groups of three to five students. Distribute Student Sheets and materials.
2. Conduct experiments according to the procedure on Student Sheet
3. Answer questions and sketch experimental results. Have groups report findings.
4. Conduct a discussion based on questions on the Student Sheet. Relate layers—in the experiment to differentiation in an asteroid or planet.

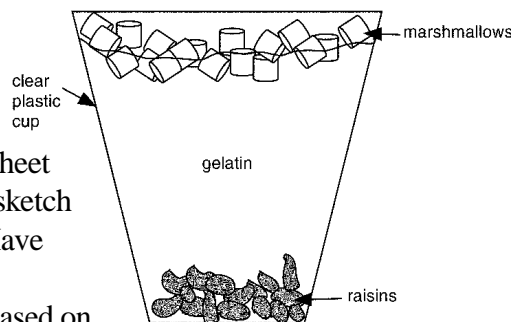

About This Activity

Students will conduct experiments with food in gelatin to simulate the differentiation of planetary bodies into a core, mantle, and crust.

Materials for Activity B Per Group of Students,

except where noted.

- 1 box of light colored gelatin dessert (*yellow shows process clearly*)
- metric measuring cup for liquids
- bowl
- mixing spoon
- 270 ml (9 oz.) clear plastic cups (*one per student*)
- 470 ml (2 cups) boiling water (*this keeps gelatin hot for a longer time*)
- heating source for water (*teakettle, hot plate or microwave in central location*)
- pen or pencil
- Student Sheet (*pgs. 11.5-11.7, one per student*)
- food items that sink*
raisins, fresh grapes, orange slices, canned peaches, pears, pineapple,** olives
- food items that float*
marshmallows, peanuts, fresh apples, bananas, pears

**temperature of gelatin may cause some foods to change sinking and floating behavior.*

***canned mixed fruit in light syrup floats, but mixed fruit in heavy syrup sinks.*

About This Activity

Students will discover, by smashing hard-boiled eggs, how impacts break up a differentiated body so that the core and mantle are exposed. They will relate the meteorites in the Meteorite Sample Disk to parts of a differentiated body.

Materials for Activity C

- frozen hard boiled egg (*one per student if possible — stores may donate out of date eggs —wasting food is not the objective of this exercise*)
- dry ice (*easily obtainable at some grocery and ice cream stores*)
- picnic cooler to hold dry ice
- safety goggles
- thermal protective gloves
- lab apron
- liquid nitrogen and container (*optional*)
- Student Sheet (*pg. 11.8*)
- large plastic tarp approximately 4m x 4m
- duct tape
- wall
- broom
- waste container

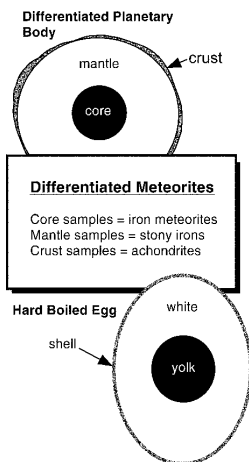

Lesson 11 — Changes Inside Planets

Activity C: Egg Smash: The Break-up of a Differentiated Body

Objectives

Students will:

- relate meteorites to the core, mantle and crust of asteroids.
- model the break-up of a differentiated body to expose the interior layers.

Procedure

Advanced Preparation

1. Boil eggs, then freeze eggs using one of the following methods. **Do not** freeze longer than suggested or the texture will not be ideal. Freezing methods:
 - 10-15 minutes in or on dry ice (depends on number of eggs frozen at one time). Preferred method.
 - 2 minutes in liquid nitrogen (one egg at a time). Ideal, but difficult method.
 - 48 hours in freezer. Simplest method, but least satisfactory.

Use proper lab safety precautions!! Always handle dry ice, or something frozen by dry ice, with thermal protection gloves. Lab apron, face protection, and thermal protection gloves must be worn when using liquid nitrogen or something frozen by liquid nitrogen. Consult the Materials Safety Data Sheet for full safety precautions.

2. Choose a hard surface like a concrete driveway where eggs may be broken, and clean-up will not be difficult. **OR** Choose an area of wall away from windows and doors where the concrete floor meets the side of a building. Tape a plastic tarp securely to the wall. Make sure that part of the cover extends to cover the ground. (This makes clean up more efficient.)

Classroom Procedure

1. **Safety goggles and thermal protective gloves should be worn.**
2. With classmates at a safe distance, one student throws a frozen, hard boiled egg at the designated area (repeat if it does not break the first time). Repeat with other eggs.
3. Using Student Sheet, all students write observations and illustrate the broken egg, labeling the crust, core and mantle.
4. Use questions to focus discussion and relate broken pieces to meteorite types.

Student Sheet: Activities A, B and C

Activity A: Differentiated Meteorites

Carefully observe the achondrite, iron, and stony-iron samples in the Meteorite Sample Disk or photographs. Describe and sketch them using the space below.

How do you think these meteorites formed?

Activity B: Food Differentiation

Materials Per Group of Students (except where noted)

- | | |
|---|---|
| <input type="checkbox"/> 1 box of light colored gelatin dessert | <input type="checkbox"/> 270 ml (9 oz.) clear plastic cups (<i>one per student</i>) |
| <input type="checkbox"/> metric measuring cup for liquids | <input type="checkbox"/> 470 ml (2 cups) boiling water |
| <input type="checkbox"/> bowl | <input type="checkbox"/> food items |
| <input type="checkbox"/> mixing spoon | <input type="checkbox"/> Student Sheet and pencil (<i>one per student</i>) |

Procedure

1. Groups collect materials for experiment (see list above).
2. Each group member will predict and record information below.
 - Each member will select two food items: one you predict will sink and one you predict will float. Make sure your group uses a variety of food items.
 - Record predictions. _____ will float in gelatin
_____ will sink in gelatin
 - Each member place a spoonful or less of both food items in your individual plastic cup.

4. Why did you choose the particular foods in your experiment? Have you ever had an experience with this food and its floating properties before? Describe.

5. Were some foods used by your group not consistent in their floating behavior? Why do you think this happened?

Could you change the conditions to make the floating more consistent?

6. Compare what happened in the gelatin experiments with the core, mantle and crust of differentiated planetary bodies like Earth. Be sure to discuss which parts of the gelatin represent parts of Earth.

7. Which meteorites in the Meteorite Sample Disk relate to each of the gelatin layers?

Activity C: Egg Smash

Questions

1. What parts of a differentiated asteroid do the yolk, egg white, and shell represent? Sketch and label an egg and include the comparable planetary layers.
2. How is the core or the inside of a differentiated asteroid exposed?
3. If you wanted to study the metal in an asteroid, which section of the asteroid would you study?
4. How are Earth and an achondrite asteroid alike? Different?

Exploring Meteorite Mysteries

Lesson 12 — Building Blocks of Life

Objectives

Students will:

- recognize that carbonaceous chondrite meteorites contain amino acids, the first step towards living plants and animals.
- conduct experiments that simulate how the carbon material and water from carbonaceous chondrites may have helped early life on Earth.

Background

People have repeatedly asked the questions “How did life begin?” and “Are we alone in the universe?”. The exploration of our solar system has shown that Earth is the only body currently capable of supporting surface life. However, there is fascinating evidence that other bodies may have been habitable in the past or below the surface. Mars may once have been capable of supporting surface life. In places on Mars where volcanic and impact heat interacted with water, hot springs may have formed. On Earth thermal springs harbor microbial life. Mars may still be capable of supporting simple life in subsurface groundwater, ice, or cracks in rocks. Scientists have found intriguing evidence that may be fossil bacteria in cracks in an ancient martian meteorite, but that interpretation is still hotly debated. Other habitable environments might include a possible liquid ocean under the ice of Jupiter’s moon, Europa, or some of the newly discovered planets around other stars. If conditions were right, could life have developed elsewhere? Meteorites provide the evidence that the building blocks of life were available to other worlds.

Carbonaceous chondrites contain the two essential components for life, water and complex carbon compounds. Some of the carbon compounds are amino acids, the building blocks of DNA molecules, which contain hereditary information for all life on Earth. Detailed studies of the amino acids in meteorites show that they were not formed by living things. This means that inorganic processes in the solar nebula, or later within the rock itself, were able to make complex carbon compounds from simple molecules containing carbon, hydrogen, oxygen, and nitrogen. Carbonaceous chondrites may have delivered these building blocks of life to various bodies in the solar system. Some scientists believe that the beginnings of life on Earth partially depended upon availability of water and carbon compounds from carbonaceous chondrites. These materials would certainly also have been delivered to early Mars.

“How did they form?”

About This Lesson

The team activities in this lesson explore the important materials carbonaceous chondrites brought to Earth. A jumbled letter activity leads students to look at the amino acids found in carbonaceous chondrites as the building blocks of life. Students also experiment with growing yeast in mediums that represent carbonaceous chondrite material.

Vocabulary

amino acids, DNA, carbon, carbonaceous chondrites

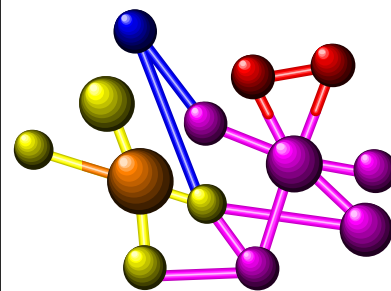

Activity A: Alphabet Soup

About This Activity

Student teams try to discover the hidden words “amino acids” using cutout, jumbled letters. They progress to the analogy that just as the letters are essential to “building” words so are amino acids, found in carbonaceous chondrites, essential as building blocks of life.

Materials for Activity A

- individual letter sets for each team (*press cut-outs, etc.*) see Advanced Preparation
- envelopes large enough to hold approximately 20 letters (*1 per team*)
- paper and pencil for each team
- Student Sheet (*pg. 12.5*)

Objective

Students will:

- recognize that carbonaceous chondrite meteorites contain amino acids, the first step towards living plants and animals.

Procedure

Advanced Preparation

1. Prepare one envelope for each classroom team. Envelopes should each have the letters necessary to spell “amino acids” and an appropriate number of additional letters to challenge the students.

Suggested letter groupings:

- #1 - aminoacidsbeghlmnust
- #2 - aminoacidsabffjklmmr
- #3 - aminoacidscfijopprty
- #4 - aminoacidsceehjloor
- #5 - aminoacidsdgikllsuwz
- #6 - aminoacidsdeggmrtuy
- #7 - aminoacidsacegimnnqt
- #8 - aminoacidscffillnppu

For more advanced students use the names of individual amino acids.

Glycine, Alanine, Valine, Leucine, Isoleucine, Serine, Cysteine, Cystine, Aspartic Acid, Asparagine, Threonine, Methionine, Glutamic Acid, Glutamine, Proline, Lysine, Arginine, Histidine, Tryptophan, Phenylalanine, Tyrosine



2. The activity may be simplified by using one color for the letters that spell “amino” and another color for “acids” and different colors for the extra letters. No two collections should be the same in color or letters.
3. Copy Student Sheet.
4. Review the lesson background.

Classroom Procedure

1. Divide class into teams and distribute envelopes with letters.
2. Using the letters, teams list words they can think of that could be made if **just one more** letter was available.
3. Teams spell words using the letters in the envelopes.
A team recorder writes all words discovered.

Note: Teacher should monitor the progress being made.

After appropriate “wait” times, teams will be instructed to progress through the remaining procedural steps.

4. Teams compare letters with a nearby team. At teacher’s signal, sharing teams will compare with other teams, seeking common letters and words.
5. Exercise continues until students discover the term “amino acids,” with or without teacher intervention.

Intervention “Hints” from broad to narrow:

- “Do teams near you have any of the same letters?”
- “You’re looking for two words.”
- “Both words begin with the letter a.”
- “The words are associated with carbonaceous chondrites.”
- “The words represent something important to life.”
- “Here are the blanks to play Hang Man. What letters are common to all teams?”

6. Distribute Student Sheet.
7. Teacher leads a discussion based on the lesson background information and the questions on Student Sheet. Stress the comparison of letters as building blocks of words to amino acids as building blocks of life.



Lesson 12 — Building Blocks of Life

Activity B: Get a BANG Out of Life!

About This Activity

Students model the effects of meteorites bringing water and carbonaceous material to Earth. They experiment with growing yeast in mediums that represent carbonaceous meteorite material.

Materials for Activity B **Per Small Group or Class**

- 1 package bakers' yeast
- 0.20 liter warm water
(110 °F/ 43.3 °C)
- 3-4 crushed chocolate
snaps (*or other*
carbohydrate i.e., sugar)
- measuring container
- large spoon
- 2 large clear containers
(*liter jars*)
- thermometer
- Student Sheet (*pg. 12.6,*
per student)

Objective

Students will:

- conduct experiments that simulate how the carbon material and water from carbonaceous chondrites may have helped early life on Earth.

Procedure

Advanced Preparation

1. Gather equipment.
2. Copy Student Sheet.

Classroom Procedure

1. Students gather materials.
2. Measure 1/2 package of yeast into both containers.
3. Add 0.10 liter warm water to each container and stir.
4. Add crushed cookies to one container and stir.
5. Leave both containers in a warm place.
6. Predict what will happen in each container.
7. Observe how both batches of yeast react and grow.
8. Conduct class discussion on the effects of adding water or both water and carbon compounds.
9. Complete the questions on the Student Sheet.

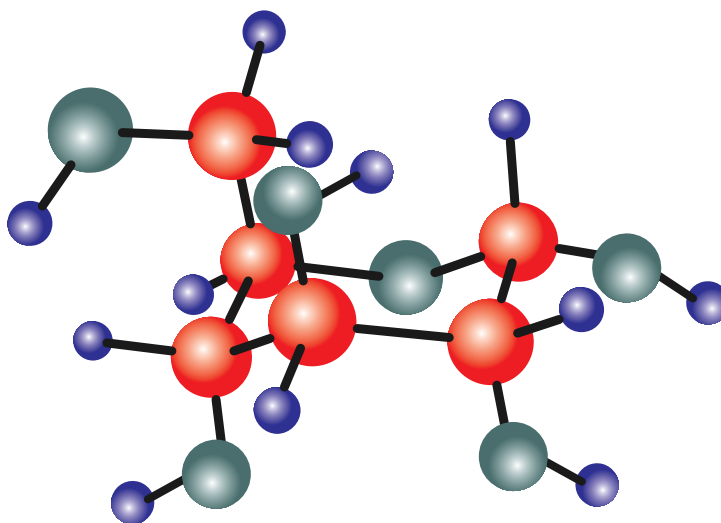

Lesson 12 — Building Blocks of Life
Student Sheet: Activity A

Questions

1. What are some words you could have made if you had been given just one more letter.
2. What are some of the words you were able to make with your letters?
3. Fill in the blanks: We could not have spelled _____ if our envelope had not contained the letter “_____”?
4. **Extra:** How are amino acids the building blocks of life?
5. **Extra:** What is the significance of the discovery of amino acids in carbonaceous chondrite meteorites?



Exploring Meteorite Mysteries

Lesson 13 — Solving a Mystery

“How
did they
form?”

Objectives

Students will:

- conduct an investigation.
- observe and record the physical characteristics of an unknown rock (meteorite).
- determine the mass of the unknown rock using math skills to track sample chips.
- determine the density of a rock.
- describe and classify a meteorite.
- apply observations and knowledge to the process of a scientific investigation.
- present evidence to verify classification decisions.
- explore concepts of spatial relationships.

Lesson Structure (All parts A-D are necessary for completion.)

Four photographs provide the evidence for the students' investigations. The goal is to gather enough information to identify the unknown rock in the photograph. At each step the students will check whether there is enough data to identify the unknown, or at least eliminate some of the possibilities.

Part A. Looking for Clues

- Start investigation of unknown by observing the rock in Lithograph I.
- Emphasis is on describing color, texture, and shape.
- Use Lithograph II to view from a different perspective.

Optional

- Construct paper cube and use a die to develop understanding of spatial relationships.
- Manipulate the orientation cube used with meteorite samples to understand why it is important.

Part B. Vital Statistics

- Measure the dimensions of the unknown (Lithograph I and II).
- Determine the density of the rock.

About This Lesson

This is a culminating lesson in four parts. It is designed to follow meteorite identification activities. A minimum sequence is Lessons 1, 8, 9, 10, 11, and 13. It would also be useful after geologic sample identification activities. The goal for the class is to gather enough information to identify the unknown rock. This will be accomplished by using photographs to observe, describe, measure, illustrate, and classify the “unknown” (Noblesville meteorite). Scientific identification processes will be simulated. As the class progresses through each step of the activity they will be asked “What would be your next step to classify this rock?”. The teacher will lead the students to recognize the need for additional, usually more detailed, information. Stress that even though they may guess or have a “hunch” what the unknown is (a meteorite), **they must present evidence to verify their decisions.** See “Hints” throughout the procedure.

Part C. Narrowing the Suspect List

— Observe the interior of the rock in detail (Lithograph III).

Part D. Nabbing the Culprit

— Use a microscope photo of a thin section of the rock to complete the identification (Lithograph IV).

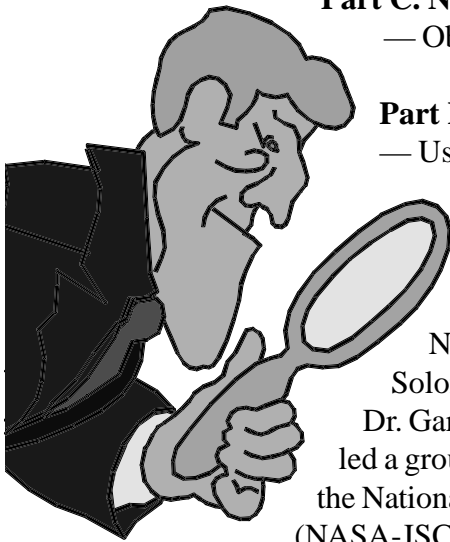

Background (See also Lesson 1)

After Brodie Spaulding and Brian Kenzie observed the fall of the Noblesville meteorite, they sent the specimen to astronomer Dr. Solomon Gartenhaus at Purdue University for classification and study. Dr. Gartenhaus contacted Purdue meteoriticist Dr. Michael Lipschutz who led a group of scientists to study the meteorite. He arranged for curation at the National Aeronautics and Space Administration's Johnson Space Center (NASA-JSC). The meteorite was sent to NASA for initial description and classification by the curators at the lab. The curators photographed, weighed, measured, and described the meteorite, then took 20 grams of chips for further scientific study. One chip was used to prepare thin sections for mineral analysis and microscopic textural observations. They found that Noblesville is a meteorite breccia consisting of numerous large white clasts in a dark gray matrix.

Abundant metal and a few small chondrules can be seen in the specimen, showing that it is a metal-rich chondrite. Mineral analyses confirmed the high-iron nature of both clasts and matrix and showed that the clasts are highly metamorphosed, while the matrix is only slightly metamorphosed. This type of chondrite breccia is rare. It is a regolith breccia similar to some lunar breccias. The curators also sent chips of the meteorite to several geochemists for elemental and isotopic analyses. These scientists found that Noblesville is rich in gases deposited by the solar wind.

Vocabulary

astronomer, attrition, breccia, chondrite, chondrule, classification, clast, curation, curator, density, fusion crust, geochemist, isotope, matrix, metal, metamorphic, meteoriticist, regmaglypt

Advanced Preparation

1. Be familiar with background information and comfortable with vocabulary (see glossary).
2. Assemble all materials and be very familiar with the order in which they will be used.
3. If only one original set of photographs is available, good photo copies will work. Use copies for the groups and display originals for consultations.

Lesson 13 — Solving a Mystery

Part A: Looking for Clues

Objective

Students will:

- observe and record information from close examination of two photographs of the unknown rock.

Procedure - Step 1

Suggested introduction to be used by teacher:

Have you ever been confronted with a real mystery?

- *Someone has written an anonymous love note to you, and you can't figure out who it is!*
- *Something has disappeared and you KNOW it was there a minute before.*
- *You've found something weird and you can't figure out what it is or where it came from.*

Some professionals spend their entire careers solving mysteries for people. THIS time, YOU will be the investigators.

1. Divide class into groups of 3-5 students.
2. Students examine Lithograph I as a group and using the Team Data Sheet write individual descriptions of the rock. Include shape, color, texture, and hypothesize as to its identity. Allow students to check original color photo if they are using photo copies.
3. Students may share descriptions and hypotheses.
4. Solicit ideas for further investigation and lead students to recognize the need for more information — a picture of the rock from a different perspective.

Hint: Students may ask for the actual rock. Point out that private investigators often search for missing persons and have only a photograph for their first clue.

Procedure - Step 2

1. Examine Lithograph II. Students record similarities and differences of the two photographs (Lithos I and II) on the Team Data Sheet. Focus on big rock, not small pieces.

About Part A

Students will start their investigation by observing the rock in photographs.

Materials for Parts A-D **Per Group of Students**

Note: Materials should be distributed as needed for each step of the investigation.

- Lithograph Set (*Lithographs I-IV show 4 photographs of Noblesville meteorite*)
- Lithograph copies if needed
- Suspect List, pg. 13.15, (*used in Parts C and D*)
- Team Data Sheet, pgs. 13.13-13.14, (*per student*)
- Meteorite ABC's Fact Sheet (*pgs 29-30*) (*used in Part D*)
- NASA JSC Notes - Extended Comments (*pg. 13.11*)
- individual writing materials
- paper clips
- transparency or similar plastic sheet
- transparency marker
- metric ruler
- one overhead projector for class
- single die - optional
- patterns for orientation cubes for each student - optional (*pg. 13.12*)
- scissors
- glue

Hint: Two photographs of the same person often look like different people. A different perspective can make a big difference.

2. Allow students to discuss comparisons, and reveal all evidence they have observed.

Hint: Exterior “coat” which could be fusion crust should be identified by this point; therefore, this rock “may be a meteorite.” Since they have presumably been studying meteorites this is a logical step since hypotheses come from evidence coupled with prior knowledge. But they must present evidence!

Looking for Extra Clues

Optional Extension

(use after Part A)

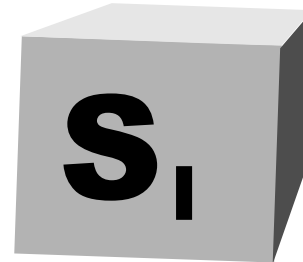

Objective

Students will:

- explore concepts of spatial relationships.

Procedure

Suggested introduction:

Just as an investigator might start off with a photograph of a missing person, we have two photographs of an unidentified rock. Is there anything else in either photograph that might provide additional clues about this rock? (Lead class to notice orientation cube if necessary.) What do you think the little block is? (Point out letters. Solicit comments.)

Sometimes investigators make simulations of items they can see in photographs. I have some patterns to make cubes. If we experiment, maybe we can figure out why cubes are in both of the pictures?

1. Distribute individual cube pattern sheets and scissors.
2. Students label sides of cube shown in pictures. This may be done after construction if desired.
3. Teacher leads class in supplying “missing” letters and students finish labeling cubes.

Hint: Looking at the two cubes, I see the letter ‘E’ on both of them. Assuming that both cubes are identical, how would the ‘T’ and ‘B’ relate to each other? (Opposite each other — T for Top & B for Bottom) Now that we’ve dealt with the T and the B, let’s look at the leftover letters. Where have you seen an N and an E together before? What could they stand for? (North and East) If students do not recognize the letters as directions, identify them as such. S and W are not visible in the photographs but students should put them on their cube model.

4. Students fold and glue cubes.
5. Teacher solicits possible uses for cubes.
6. Students relate cubes to picture, determining that the rock has been turned upside down in the second photograph.

Hint: When police arrive at a crime scene, it is common practice to orient objects (bodies) using strips of tape before photographing the scene. This allows for effective “further investigation.”

7. Demonstrate the use of orientation cube using die.
 - Group leader will place cube next to die on lab table with the cube’s “T” face on top and “N” face indicating north. Die should be placed with “5” and “6” faces of die oriented to “T” and “N” respectively.
 - As other members of each group record instructions, group leader will flip or rotate both the cube and die **simultaneously** as teacher calls out and models instructions. **Note:** Both die and cube **must** be flipped or rotated the **exact** same number of times in the **exact** same direction(s).
 - Teacher will point out that the relationships of the “T” and “5” as well as the “N” and “6” are still the same after the first few instructions.
 - Teacher will verify comprehension.
 - Group leader, aided by recorded data of teammates, will return both die and cube to initial placements and orientations.
 - Groups will divide into two teams each. While one team looks away, the other team will change the orientation of the die and cube simultaneously, flipping and rotating at least 3 times (one teammate must record “moves”).
 - The inactive team will attempt to return both the die and cube to their initial positions without help (if asked, the active team may give hints after a reasonable effort has been made).
 - Teacher will support teams struggling with task throughout exercise.
 - Teams will switch “jobs.”
8. Class will work with cubes, and demonstrate initial orientation of a variety of objects in the classroom.

Hint: Noting the placement of cubes in photographs, we can determine the exact placement of an object when it was found: both “which end was up” and its geographical orientation (whether it was “facing” north, south, etc.). If items must be moved, either during a crime or scientific investigation, the investigator often must duplicate the scene. Without orientation devices, this would be impossible. Geologists use this technique when they saw rocks into pieces. They must know exact placements of parts in relation to the original specimen, particularly when they are being held accountable for national treasures like the lunar samples or rare meteorites.



Lesson 13 — Solving a Mystery
Part B: Vital Statistics

About Part B

Students will take measurements and determine the density of the specimen.

Optional

1. Optional - Students may calculate the approximate density (grams per cubic centimeter).
2. Bonus Question - Ask students how an investigator could find the volume of an irregular object. Answer could be the standard liquid displacement procedure or a new computer imaging process.

Hint: If density is calculated, “iron meteorite” may be eliminated at this point (iron density = 8, stone density = 3.3 - 4.5) Actual Noblesville Density is 3.9.

Objectives

Students will:

- measure the size of the unknown rock.
- determine the mass of the unknown rock using math skills to track sample chips.
- estimate the density of a rock.

Procedure - Step 1

Suggested introduction:

Just as an investigator needs vital statistics on a missing person, measurements are the next logical step in identifying this rock. For all we know, this thing is as big as a house. Is it a pebble or a boulder? How can we find out its size?

1. Solicit suggestions as to how the rock might be measured.
2. Disclose actual dimensions of cubes in photographs. Cubes are 1 cm on a side, not the same size as cube in optional step.
3. Groups measure or estimate dimensions of unknown, based upon Lithographs I and II and record data on the Team Data Sheet.
4. **Optional:** Class may average data to estimate size or they could create a table or graph based on the data.

Procedure - Step 2

1. Students find the total mass of all the parts of the unknown.
2. Have students compare initial mass of the unknown and the total mass of broken pieces (see Team Data Sheet for data). The difference is 0.1g (not 4.1g - some may neglect to include the 4g piece removed prior to processing at NASA).
3. Class will hypothesize about reasons for the difference in mass. The difference is due to attrition, fine dust and tiny pieces lost in sample processing. However, some students might suggest a weighing mistake or a rounding error (both are possible).

Lesson 13 — Solving a Mystery

Part C: Narrowing the Suspect List

Objectives

Students will:

- describe and draw details of an unknown rock.
- apply observations and knowledge to the process of a scientific investigation.

Procedure

Suggested introduction:

If you get a present and want to know what it is, you might shake it, heft it, sniff it, etc., but you will eventually OPEN it. We've examined the rock in our photograph pretty thoroughly. Where do we go from here? (Solicit "look inside" response.)

Looking inside something is another typical investigative technique. Since we don't have the actual rock we're attempting to identify, we'll use an additional photograph of the interior of the rock. The inside was exposed when a section of it was removed.

This magnified photograph is helpful because it allows us to see INSIDE the rock. What additional clues can we obtain from this detailed view of the unknown rock? (Solicit answers.)

Investigators often use another technique when attempting to locate a suspect. They call in a police artist and, based on descriptions of witnesses, compile an artist's sketch.

Your job is easier than that. I'd like you to examine this detailed view and prepare an artist's sketch of it.

1. Students examine Lithograph III as a group. Each student will draw this detailed portion of the unknown. Labels will be added after step 3 below.
2. Distribute Suspect Lists and have students fill in their observations based on the investigations to this point.
3. Teacher will lead students to begin the narrowing process.



About Part C

Observations of the interior of the specimen are made.

Just as investigators label drawings to clarify information, I'd like you to label your drawing. Since it appears more and more that this rock may be a meteorite, try using terms from this word bank for your labels: breccia, chondrules, clast, fusion crust, matrix, metal.

4. Instruct students to label their illustrations with at least three appropriate vocabulary words. Depending on the level of experience students have with meteorites, the words may be from a word bank or from the students' previous studies.

Hint: *The texture of the unknown is a breccia texture — clasts (broken fragments) contained in a matrix. Carbonaceous chondrite will be eliminated at this point (very few black veins and little matrix). If chondrules are recognized, achondrite may also be eliminated.*

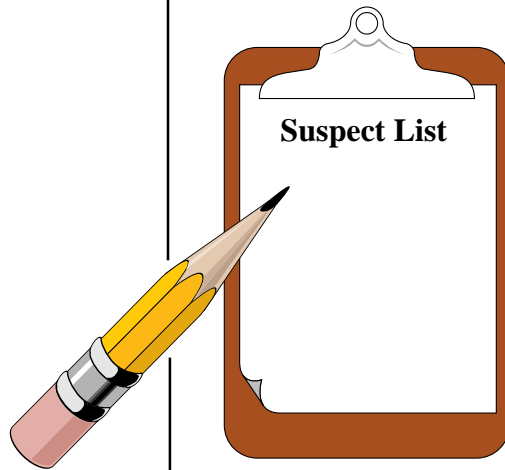

Lesson 13 — Solving a Mystery
Part D: Nabbing the Culprit

Objectives

Students will:

- observe and draw detailed microscope view of unknown.
- present evidence to verify classification decisions.

Procedure

Suggested activity introduction:

We've observed and recorded information about our rock from more than one perspective. Any ideas on a next step? I'm remembering a picture I've seen of an investigator peering at something on the floor through a magnifying glass — like Sherlock Holmes. Why would he have done that? (To make things look larger so more details may be seen.) With all the technology available to us now, how would a modern investigator accomplish that same thing? (Microscope)

Along with microscopes, modern investigators now have special cameras they can attach to microscopes for taking pictures. Geologists have even figured out a way to cut a skinny little piece of rock that is so thin that light will pass through. It's called a thin section. Lithograph IV is a thin section of our rock. This is what scientists see through a special microscope.

1. Groups will receive transparency sheet and marker. They will lay the transparency sheet over lithograph of thin section and secure with paper clips. Trace corners on transparency to make it obvious if the paper slips.
2. Possible chondrules and bits of metal, (shaded) will be traced. (Metals block light and look black under the microscope.)
3. Groups will compare transparencies by aligning and stacking them on the overhead and viewing simultaneously to detect differences in observations. Help students clarify the clast boundaries.
4. Using the Suspect List the class will attempt to eliminate “suspects” by process of elimination. If further information is needed, students may use the Meteorite ABC’s Fact Sheet on pgs. 29-30, of the Teacher’s Guide.

Hint: *Chondrules WILL be identified at this point; therefore, achondrite is eliminated. If density has not been calculated*

About Part D

Students use a microscope photo of a thin section of the rock to complete the identification.

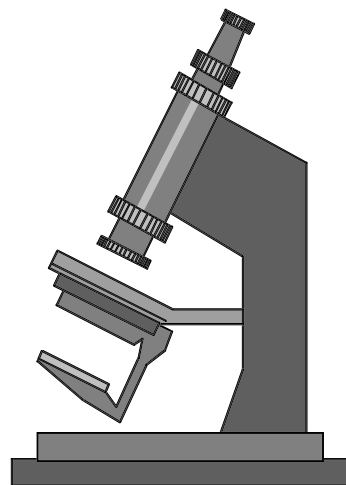

then students will need to use the photographs and descriptions in the Introductory materials to eliminate iron and stony-iron. See the Background Information on pg. 13.2 of this lesson for a detailed description of the Noblesville meteorite.

5. Class will discuss/summarize investigative process and conclusions reached.
6. Students will only be expected to identify the unknown as a chondrite or possibly as a chondrite breccia. Noblesville is a metamorphic regolith breccia made of clasts of H chondrites in a matrix.
7. Teacher will identify the rock as the Noblesville meteorite and the original investigators as the meteoriticists who identified and classified it.
8. Class will compare and contrast the descriptions of the meteorite prepared by the students with the initial descriptions prepared by NASA scientists at the Johnson Space Center. See NASA JSC Notes - Extended Comments pg. 13.11.

Lesson 13 — Solving a Mystery
NASA JSC Notes

Use only after students have completed Part D

Initial description prepared by NASA scientists
at the Johnson Space Center

Compare this description with students' descriptions of Noblesville.
Point out similarities in their descriptions but do not expect students' observations to be exact.

NASA JSC

Notes / Extended Comments

Sample: **Noblesville** *non -Antarctic meteorite*

Description By: Satterwhite 10/17/91

Dimensions - 9.5 x 8 x 3.5 cm

Exterior of this sample is covered with dull black fusion crust. Bottom surface of exterior is brown, top surface has several regmaglypts and some residual dirt. Small area on exterior is chipped away and reveals a medium grey matrix with some white angular clasts.

Interior is fine-grained medium grey with numerous angular white clasts. A few distinct chondrules are visible. Some very small chondrules and fragments are seen. Abundant fragmented grains with metallic luster are visible. White clasts are coarser grained. More metal sulfide and some medium-grained yellow grains (olivine?).

Weathering - A+ recent fall

Fractures - A

Weight - 483.7 g



Orientation Cube Pattern

(not same scale as photographs)

1. Cut out pattern.
2. Fold along lines to make a cube shape.
3. Glue tabs to inside of cube.

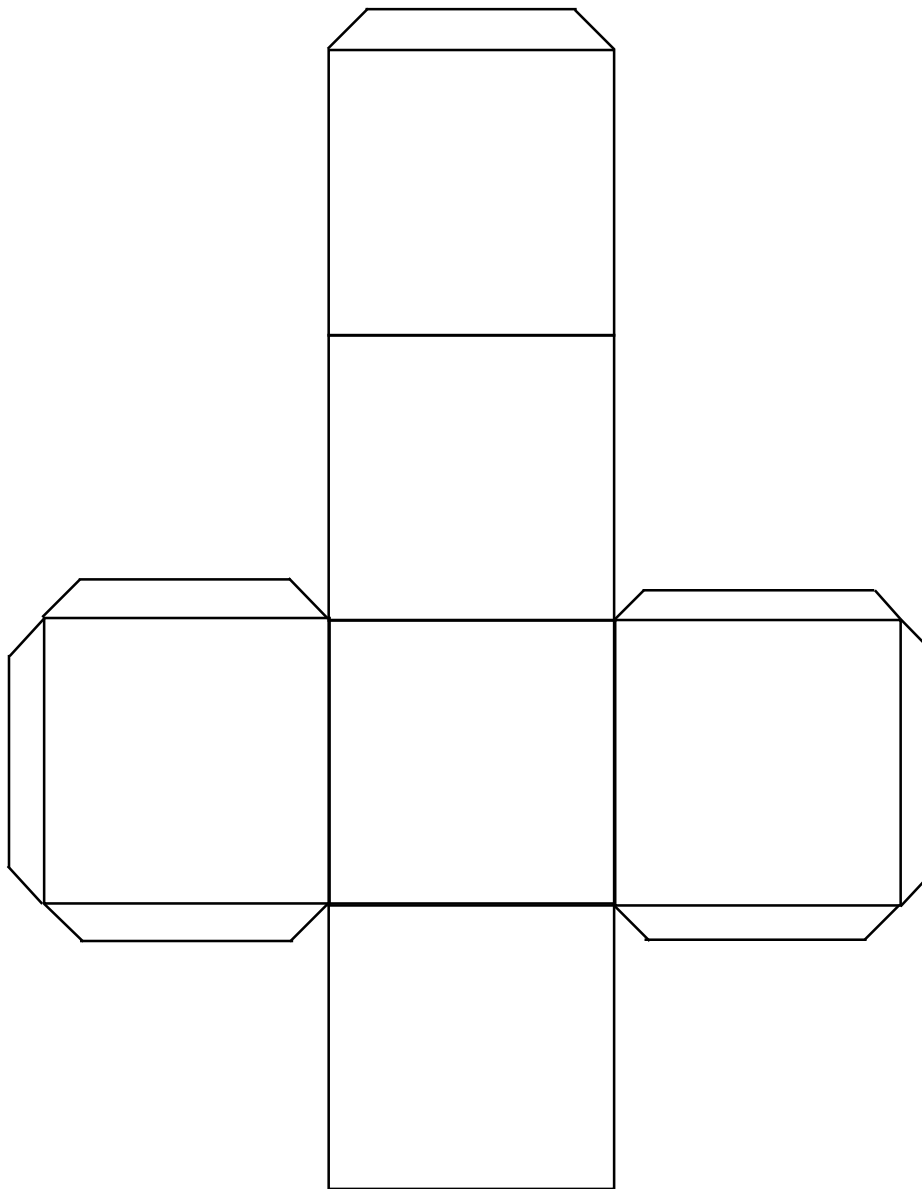

Lesson 13 — Solving a Mystery
Team Data Sheet

Name: _____

Team: _____

Part A: Looking for Clues

Step 1: Lithograph I

Describe the rock (shape, color, texture, etc.) What do you think it is?

Step 2: Lithograph II

View both photos and record the similarities and differences revealed about the rock.

Part B: Vital Statistics

Step 1:

How big is this rock?

Estimate the rock's volume in cm^3 . Why is this estimate not very exact?

Step 2: Finding the rock's mass

The mass of the rock described in the NASA Lab was 483.7g before chips were chiseled off for scientific studies. A small 4.0g piece was removed before it arrived at NASA, thus the total initial mass of the rock was 487.7g.

What was the total mass of the rock including all the pieces? (chip 0 weighed 466.4g, chip 1 weighed 12.4g, chip 2 weighed 1.6g, chip 3 weighed 3.2g)

Why was there a difference in the original weight and the total weight of the pieces?

Step 3: Optional

Estimate the rock's density in g/cm^3 , showing your math. How could this estimate be inaccurate? How should you adjust your estimate?

Part C: Narrowing the Suspect List

Sketch the inside of the mystery rock using Lithograph III. Note significant features observed.

Part D: Nabbing the Culprit

Trace the features shown in the microscope photograph onto a transparency sheet. Show detail. Use the space below to describe what you see in Lithograph IV.

Lesson 13 — Solving a Mystery
Suspect List

Name: _____

Yes or No	Reason (<i>be specific</i>)
<p>Earth Rock</p> <p>Sedimentary</p> <p>Igneous</p> <p>Metamorphic</p>	
<p>Meteorite</p> <p>Iron</p> <p>Stony - <i>Chondrite</i></p> <p> - <i>Carbonaceous</i> <i>Chondrite</i></p> <p> - <i>Achondrite</i></p> <p>Stony-Iron</p>	

Exploring Meteorite Mysteries

Lesson 14 — Direct Hit at the K-T Boundary

“What effect do they have?””

Objectives

Students will:

- evaluate and apply data from a narrative to a scientific selection process.
- demonstrate or visualize simulations of some of the effects of a huge impact.
- write a point of view narrative.

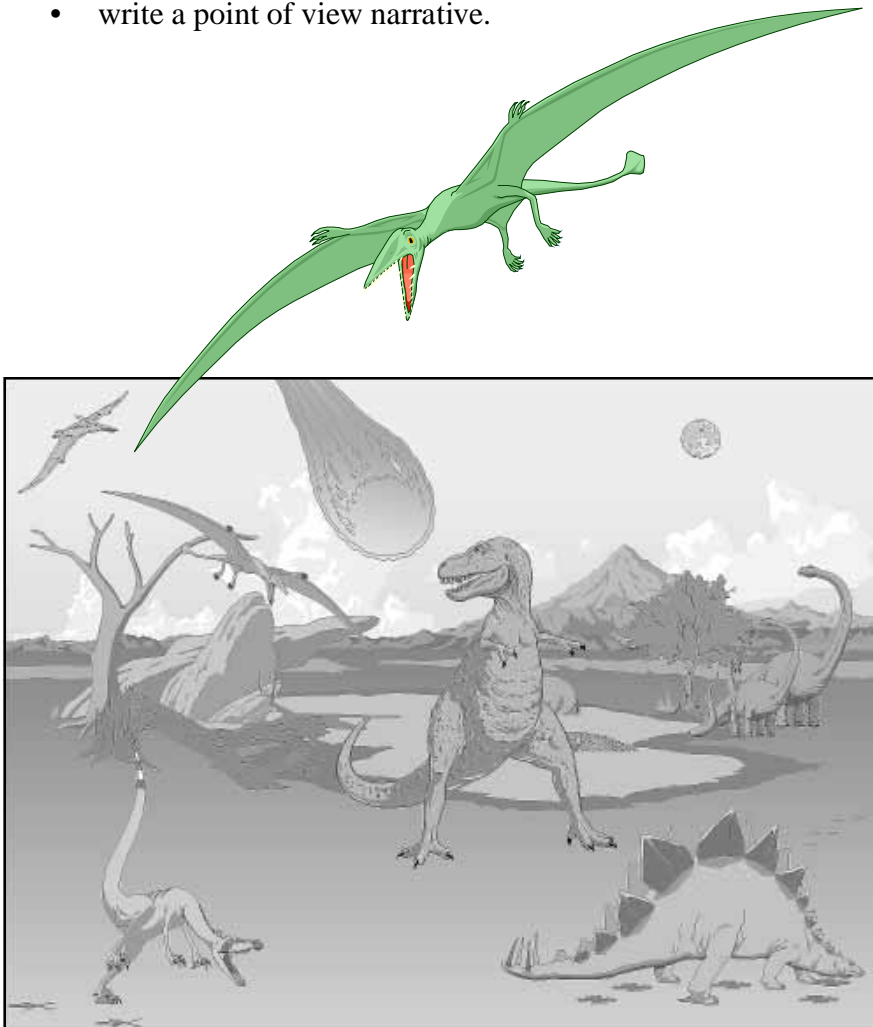

About This Lesson

In this lesson, students explore information about the effects of large impacts.

A critical thinking activity helps students select the likely impact site associated with the extinction of the dinosaurs.

Using simple simulations students will find it easier to relate to the massive destruction caused by large impacts. Creative writing skills are developed by writing a first person narrative to illustrate the destruction.

Activity A: Find the K-T Crater

About This Activity

This activity starts with a short informative narrative about the extinction of many species, including the dinosaurs. An asteroid impact was identified as the major reason for the long lasting global changes that killed so many living things. But the location of the large crater, caused by the impact, was not immediately obvious. Like the scientists, the students will be asked, “Where is the crater?” Students will develop the criteria for evaluating crater candidates from the background narrative information. In teams they will evaluate selected craters to see which one(s) might have caused the extinction of the dinosaurs.

Materials for Activity A

- Student Background
(pgs. 14.7-14.8)
- Geographic Features
Suspect List (four sets
are provided,
pgs. 14.9-14.12)
- Geographic Features
Teacher Key (pg. 14.6)
- physical maps(s) of the
world
- overhead projector
(optional)

Objective

From a narrative, students will:

- select criteria and then apply them to a scientific problem by using critical thinking skills.

Background

Sixty-five million years ago three quarters of the life forms on Earth became extinct. The most well-known group to die out were the dinosaurs. However, birds may be lineal descendants of one group of dinosaurs. Other species that became extinct were the ammonites (marine molluscs like the chambered nautilus), rudistid clams (so abundant that they formed huge reefs), and whole groups of small marine organisms. The only groups of animals that were not affected lived deep in the oceans. Some land animals like the early mammals survived also. This extinction marks the end of the Cretaceous period of geological history and the beginning of the Tertiary period. Rocks that formed during these distinct periods are recognized by their fossils, which are enormously different because of the great extinction. As a shorthand (or jargon), geologists call this geological instant the K-T boundary (K for the German word for Cretaceous; T for Tertiary).

The extinction of the dinosaurs has been a source of scientific speculation. Hypotheses about the cause of the extinction have included:

- it wasn’t a single event, but a series of unrelated local extinctions;
- the extinction was a slow decline in numbers and diversity, not a catastrophe;
- the extinction was caused by a rapid change in climate from warm and wet to cool and dry;
- the dinosaurs became an evolutionary dead end and could no longer adapt to minor changes in their environment;
- living things were killed by the effects of massive volcanic eruptions (specifically those in the Deccan region of India);
- the effects of a meteorite impact caused the extinctions.

Until 1980, each of these hypotheses had strong adherents and there was no consensus at all. In that year, a crucial paper was published in *Science* that thrust the meteorite impact hypothesis into prominence and eventual acceptance by most scientists.

The K-T boundary had been investigated for many years as scientists searched for the cause of the extinctions. The rocks seemed to indicate a global catastrophe. Rocks at the exact boundary are not exposed at the Earth's surface in very many places. Some of the best exposures are in northern New Mexico, southern Canada, Italy, Spain, Denmark, and New Zealand. At all of these sites, the K-T boundary is defined by a thin layer of grayish clay. Rocks at these sites include sandstones from ancient river valleys, limestones from ocean reefs, and cherts from the ocean floor. The gray clay is present in all of them. Cretaceous fossils, marine or terrestrial, are present below the gray clay and are never found in rocks above the gray clay.

Scientists at the University of California at Berkeley (led by Nobel laureate Walter Alvarez and his son Louis) decided to investigate the clay layer at the K-T boundary to see if they could determine just how much time was represented by the gap between K and T times. A meteorite researcher suggested that the fairly constant inflow of micrometeorites that contain trace amounts of the element iridium might yield a measure of the time. Iridium is extremely rare in rocks from the Earth's surface, averaging about 0.1 parts per billion, but is much more abundant in common meteorites at about 500 parts per billion. Also, analyses for such small quantities of iridium is relatively cheap, easy and reliable using a technique called neutron activation analysis. Alvarez and his co-workers collected samples of the K-T gray clay and the surrounding rocks and analyzed them for iridium. They found an extremely high concentration of iridium (from 1 to 90 parts per billion). The iridium concentration was so high that at expected micrometeorite fall rates, the gap would represent tens of millions of years. This time sequence was not likely so they were forced to look for another reason for the unexpected amount of iridium.

Thus, the discovery reported by Alvarez, of the worldwide distribution of iridium from meteorites, has added to the evidence that a large meteorite impact did occur at the K-T time. Many scientists conducted investigations that would link this new information with the mass extinction of species.



The extra iridium at the K-T boundary also allowed Alvarez and his co-workers to estimate the size of the impacting meteorite. They calculated how much extra iridium, in grams/cm², had fallen at each of the K-T sites and computed the average iridium fallout. Assuming that the iridium had been originally deposited worldwide, they calculated their extra iridium values and

Painting courtesy of Don Davis®.

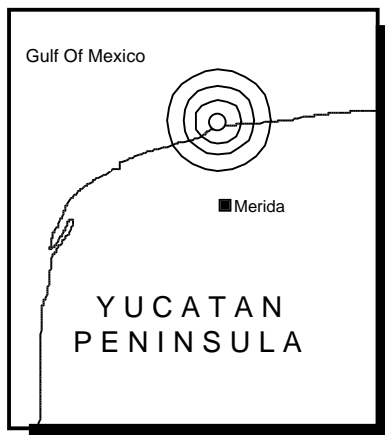

computed the total iridium fallout over the Earth. Their total iridium could have been supplied if the impacting “meteorite” were 10 kilometers in diameter, and made of ordinary chondrite material. An object this size can hardly be called a meteorite; it was an asteroid.

Once the iridium excesses in the K-T clay were known, other scientists began looking for additional evidence for a meteorite impact at the K-T boundary time. In the gray clay they found other features consistent with a meteorite impact, including grains of the mineral quartz that showed the effects of enormous shock pressure, and globules of melted rock that could have been formed in an impact. Scientists also found soot in the clay layer — enough soot to suggest that enormous fires consumed much

of the Earth’s vegetation. In the rocks below the gray clay, they also recognized deposits from enormous ocean waves that might have been tsunamis caused by an impact. In addition, they found broken rock in unusual places that suggested earthquakes (which could have been triggered by an impact).

The impact of a 10 km diameter meteorite (actually a small asteroid) must have produced a circular crater, probably more than a 150 km in diameter. A crater that size would likely have multiple ring structures, like the larger craters on the Moon. Although remnants of a few large craters like that are known on the Earth, they are all much older than the 65 million year age of the K-T boundary. The lack of a known crater made many scientists suspicious of the whole meteorite impact hypothesis, and inspired others to look for the impact crater. Many features around the world were suggested and investigated as possible impact sites.

The work centered first on North America because the largest fragments of shocked rock were found there. The Manson meteorite crater, beneath Iowa, was first targeted because it formed about 65 million years ago. But Manson is only 35 kilometers in diameter, probably too small to have caused global devastation and too small to have been made by a 10 kilometer asteroid.

Then the search focused on the Caribbean area, because the clay layer was thickest there, and had the largest rock fragments and globules of melted rock. Finally, suspicion focused on an unusual sub-surface structure on the northern coast of Yucatan (Mexico), centered under the town of Chicxulub. Studying rocks from drill cores of the area and data from remote sensing methods (gravity measurements, seismic profiles) showed that the Chicxulub structure is a meteorite impact crater. The most recent estimate of its size is 300 kilometers across, certainly large enough to have caused a global environmental catastrophe.

The effects of the meteorite hitting the Earth can hardly be described. As the meteorite hit, all life within about 300 km (the size of the eventual crater) would be vaporized instantly. Then the hot blast wave from the impact explosion would kill all life for several hundred kilometers in all directions. Farther out, the blast wave would kill, deafen and disorient many animals. In the ocean, the shock from the impact would generate enormous, world-wide tsunamis, perhaps with waves a kilometer tall. Gigantic hurricanes might also be triggered. In the Earth, the shock from the impact would be felt as huge earthquakes, and would set off other earthquakes over the whole globe.

Ejecta from the impact (sand-sized and larger) would shoot out and rain down for thousands of kilometers around. Other ejecta would leave the Earth’s atmosphere but not Earth’s gravity; it would return to Earth as meteorites so abundant that their heat would “broil” the Earth’s surface and set off

wildfires over the whole planet. Over the impact site, a mushroom cloud would rise, carrying dust from the explosion far into the stratosphere. This dust would mingle with the soot from wildfires to form a world-wide haze so thick as to block out all light from the sun. Over time, without the Sun's heat, surface temperatures on the Earth would drop 20-30°C. The combined effects of the fires, the darkness, and the cold must have devastated life and caused the collapse of almost all ecological interrelationships. Months later, when the dust cleared and the Sun finally shone again, only some seeds and the most enduring animals would still be alive. Three quarters of all species would die in the next few years, due to the loss of the ecosystems on which they depended. Early shrew-like animals were the only mammals so far discovered to have survived the disaster.

Procedures

Advanced Preparation

1. Review background.
2. Read and be familiar with the Teacher Key for Geographic Features.
3. Prepare envelopes containing sets of Geographic Features: Suspect Lists.
 - one set of four features per envelope, per team
 - repeat sets if there are more than four teams

Classroom Procedure

1. Read the Student Background as a group or individually.
2. Ask "Where is the Killer Crater?" and "What criteria (parameters) would you use to narrow the list of suspect features?"

Note: Some students may already know the name or location of the likely crater. Encourage them not to reveal the name and remind them that, like scientists, they must present proof and logical reasons for their crater choice not just "I read/saw that it was down in the Yucatan."
3. Brainstorm the criteria as a class. Take all suggestions and then combine and focus on the categories listed below. Some classes may develop only three criteria and some may have four. Be flexible, but do not focus on age alone, the true age of a feature may be difficult to determine. (Criteria: **Shape, Size, Target Material, and Age**)
4. Divide the class into teams of 3-4 students (more if necessary).
5. Distribute the envelopes of "Suspect Features", keeping the numbered groupings so that each team will have a variety of criteria to assess.
6. Ask each team to assess whether their assigned features are "likely," "unlikely," or "possible" candidates for the "Killer Crater." Maps may be used.
7. Have each group report their findings to the class. (A simple list on the chalkboard or a chart may be developed if needed.)
8. Have the class prioritize the list of craters, from "most likely" to "maybe."
9. Provide information from background as needed.

Vocabulary

crater, meteorite, asteroid, impact, iridium, clay, shock, quartz, fossil, Cretaceous, Tertiary, catastrophe, soot.

Questions

1. Could there have been more than one impact that contributed to the global catastrophe? Justify your answer.

Extensions

1. Ask students to bring articles from books or magazines that give more background information.

Teacher Key

Geographic Features

Feature/Location	Origin	Shape	Size (dia.)	Target Material	Age (My*)
GROUP 1					
Acraman <i>Australia</i>	impact	hexagonal/ circular	160 km	continental rocks	600 My
⇒ Manson Structure <i>U. S.</i>	impact	circular	35 km	continental rocks	65 My
Valle Grande <i>U. S.</i>	volcanic	circular	22 km	volcanic rocks	2 My
Elgygytgyn <i>Russia</i>	impact	circular	?	continental rocks	3.5 My
GROUP 2					
Crater Lake <i>U. S.</i>	volcanic	circular	8 km	volcanic rocks	6,000 years
Crater Elegante <i>Mexico</i>	volcanic	circular	1 km	volcanic rocks	recent
✓ Chicxulub Structure <i>Mexico</i>	impact	circular with concentric rings	300 km	continental rocks	65 My
Vredefort <i>South Africa</i>	impact	circular with concentric rings	140 km	continental rocks	2 billion yrs
GROUP 3					
⇒ Kamensk <i>Russia</i>	impact	?	35 km	continental rocks	65 My
Charlevoix <i>Canada</i>	impact	semi-circular	46 km	continental rocks	357 My
Iceland <i>Iceland</i>	volcanic	circular	400 km (larger on ocean floor)	oceanic volcanics	20 My
Lake Toba <i>Indonesia</i>	volcanic	elongate	50 km	volcanic rocks	75,000 yrs
GROUP 4					
Lake Baikal <i>Russia</i>	tectonic movement	elongate	650 km x 8 km	continental rocks	25 My
Sudbury <i>Canada</i>	impact	elliptical	max 200 km	continental rocks	1.85 billion years
⇒ Deccan Traps <i>India</i>	volcanic	roughly circular	520,000 sq.km	volcanic rocks	65 My
Barringer (Meteor) Crater/U.S.	impact	circular	1.2 km	continental rocks	49,000 yrs

* my = million years

✓ designates likely crater candidate

⇒ designates possible choices

Lesson 14 — Direct Hit at the K-T Boundary

Student Background

The death of the dinosaurs was part of a large extinction — a time when three quarters of the kinds of life (species) on Earth were killed. Most scientists are convinced that the dinosaurs and other life forms died when a giant meteorite hit the Earth. You may have heard about the crater from this impact. Just like the scientists who study the death of the dinosaurs, you too can use reason to choose which crater was the killer.

The dinosaurs died out about 65 million years ago, along with many kinds of plants and marine animals, especially ones that lived in shallow water. This change in life on Earth, and the fossils left behind, marks the end of the Cretaceous period of geological history and the beginning of the Tertiary period. Geologists commonly call this time the K-T boundary. In many places, the rock at the K-T boundary is a few centimeters of clay. Below the clay are abundant fossils of Cretaceous animals (dinosaurs or marine animals, depending on the rocks); above the clay layer, in the same kind of rocks, the fossils are gone. This clay layer marks a global ecological catastrophe, the extinction of three quarters of the life forms on Earth.

One idea was that the K-T extinctions were caused by meteorite impacts. In 1980, scientists from the University of California at Berkeley set out to test this idea. They thought that the K-T clay might contain meteorite material, and that the element iridium might be a good “fingerprint” for a meteorite impact. Iridium is a rare metal, much like platinum, and about 5000 times more abundant in most meteorites than in Earth rocks. The scientists analyzed samples of the clay, and found that it had up to 400 times the iridium of the surrounding rocks! This result proved that a huge meteorite had hit the Earth at the time of the K-T extinction. A meteorite of about 10 kilometers in diameter could have provided all of the iridium in the worldwide clay layer.

But the proof of a meteorite impact left many questions unanswered. How could a meteorite impact have caused massive deaths over the whole world? And where was the crater caused by this meteorite?



How could a meteorite impact have caused a global ecological catastrophe? Everything at the impact site would have been vaporized, and the blast wave would have killed all life for hundreds of kilometers around. Earthquakes, tsunamis, and hurricanes would also have killed many animals. But how could the effects have been global? The evidence is in the K-T clay, which is found all over the world. That clay was originally dust from the impact, and must have spread throughout the atmosphere, and then settled out to form the clay layer. In addition, the K-T clay is rich in soot, suggesting that the meteorite impact was followed by huge fires over much of the globe. The dust and soot would have blocked out the Sun for months, and temperatures would have dropped 20 to 30°C. Only the most enduring animals and seeds could have survived until the air cleared and the Sun shone again.

And where did the killer meteorite land? Where is the smoking gun? The impact of a 10 km meteorite must have made a crater, a huge circular scar, somewhere on the Earth's surface, similar to craters on the Moon, Mars, and other planets. The K-T clay again holds clues, now in the form of grains of the mineral quartz, heavily shocked by the meteorite impact. Quartz is very rare in rocks from the ocean basins, so the impact crater is likely to be on a continent or continent edge.

But exactly where? Which crater pulled the trigger on the dinosaurs? This is your chance to pick the killer crater from this line-up of suspects. Just don't bother looking for a motive.

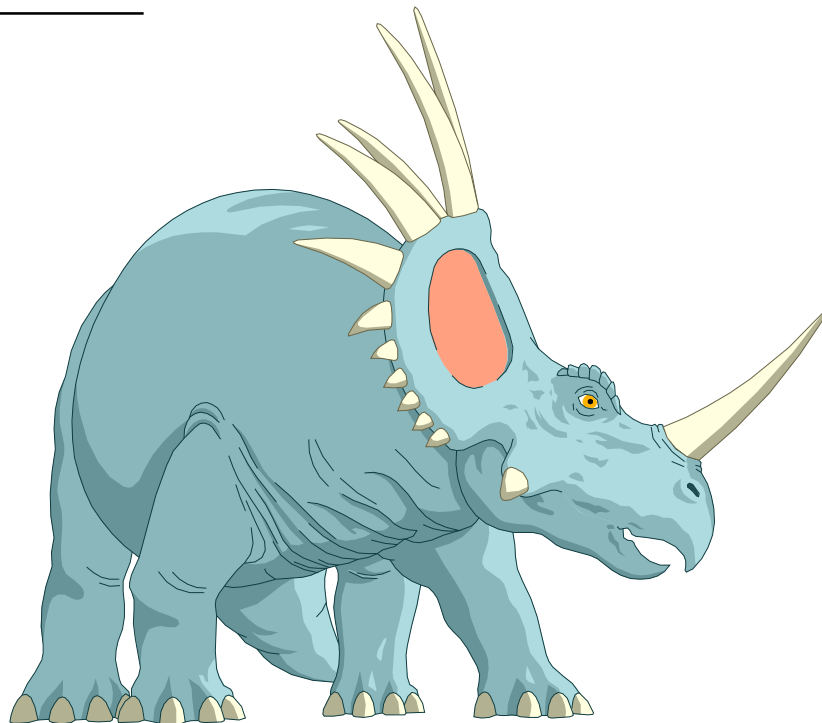

Acraman - In South Australia, Lake Acraman is a hexagonal salt lake about 20 km in diameter at 32°S, 135.5°E. Surrounding the lake are two, much larger, circular structures, which are barely visible in aerial or space shuttle imagery; the largest structure is 160 km in diameter. Rocks in the area are deformed, and a belt of broken and melted rock is present 300 km to the East of Acraman. The broken and melted rock formed about 600 million years ago, which may be the age of the Acraman structure.

Manson Structure - The Manson Structure, beneath the surface in Iowa at 42.5°N, 94.5°W, is detectable only through geophysical means (seismic profiles). It is a circular ring of granitic rock, 35 km in diameter, buried under hundreds of feet of other rocks which appear to have covered over the ring. The rocks in the Manson structure are severely broken. They were subjected to great shock pressures, and melted. The age of the Manson structure is about 65 million years.

Valle Grande - The Valle Grande is a circular basin, 22 km in diameter, in the mountains of central New Mexico at 36°N, 106.5°W. The edge of the basin is a sharp scarp, and the land slopes away on all sides. Rocks at the wall of the basin are broken and jumbled together. Within the basin is a central peak surrounded by a ring of smaller peaks. Rocks in the Valle Grande are all volcanic, with ages of younger than 2 million years.

Elgygytgyn - Elgygytgyn is a circular lake (the meaning of the name in the local tribal language) in easternmost Siberia, Russia: 67.5°N, 172°E. Around the slightly raised rim of Elgygytgyn is a ring of broken and partly melted rock. Farther away there is a halo of fractured and strongly shocked rocks. There are no volcanoes or recent volcanic rocks in the area. The crater formed 3.5 million years ago.

Crater Lake - Crater Lake is a circular basin, 8 kilometers in diameter, at the peak of a 2400 meter tall mountain in Oregon at 49°N, 122°W. The edge of the basin is a sharp scarp, and the mountain slopes away on all sides. The basin is filled with water. One peak forms an island in the basin center. Crater lake formed 6,000 years ago.

Crater Elegante - This circular depression, about 1 kilometer in diameter, is in northwestern Mexico at 30°N, 115°W. The crater has steep sides and a raised lip; the land surface slopes gently away from the crater in all directions for a kilometer or so. The crater is near the flanks of a large volcano, Cerro Pinacate, which is surrounded by many cinder cones and lava flows.

Chicxulub Structure - Chicxulub is a circular structure in bedrock beneath the Yucatan Peninsula, Mexico, consisting of concentric rings of uplifted bedrock centered at 23°N, 90°W. The largest ring is 300 km in diameter. The Chicxulub structure is buried under a great thickness of limestone, and has been mapped by remote geophysical methods (gravity and seismic profiles). Within the structure are lava rocks and minerals which have been shattered or subjected to high pressure. The Chicxulub structure is apparent at the Earth's surface only as a series of sinkholes over one of the concentric rings. The Chicxulub structure formed 65 million years ago.

Vredefort - The Vredefort ring appears as concentric circles of ridges in bedrock in South Africa at 27°S, 27.5°E. The outermost ring is 140 km in diameter and is partly covered by younger rocks. Vredefort does not look like a crater now, but it is thought to be an eroded crater. It formed 2 billion years ago.

Kamensk - The Kamensk crater is an impact scar in south-central Russia, at 48°N, 40°E. It was formed 65 million years ago and is 35 km across. Because of political instability in the region, nothing more is known about the Kamensk crater.

Charlevoix - The Charlevoix structure is marked by a semicircular valley along the St. Lawrence River in southern Quebec, Canada: 47.5°N, 70°W. If the structure was originally circular, its southern half is now under the river. Outside the valley is a band of hills, giving an overall diameter of 46 kilometers (if the structure is circular). Rocks around the structure have been strongly deformed. In the center of the semicircular valley is a central peak, composed of broken and melted rock. The age of the melted rock is 357 million years.

Iceland - This roughly circular island is located in the North Atlantic at 20°W, 65°N. It sits on the Mid-Atlantic Ridge, a volcanically active spreading center. The island is about four hundred kilometers in diameter and has many lava flows and active volcanic vents. Scientists estimate the age of Iceland to be as much as 20 million years old.

Lake Toba - Lake Toba is located in an elongate basin structure on the Island of Sumatra, Indonesia at 3°N, 99°E. The land slopes gently away from the outer edge of the fifty kilometer basin. The surrounding volcanic ash flows have been dated at about 75,000 years old.

Lake Baikal - This beautiful, elongate lake is located in southeastern Russia at 107°E, 52°N. It is the Earth's deepest continental depression with the total depth of water plus sediments at over 9 km. The lake is 650 km long and 8 km wide. The oldest sediments are estimated to be 25 million years old.

Sudbury - The Sudbury structure is an elliptical area of igneous rocks and sediments in southern Ontario (Canada) at 46.5°N, 81°W. Sudbury is inferred to be an impact crater because rocks around it show characteristic features of intense shock. Now the Sudbury structure is 140 km by 50 km, and may have been as large as 200 km diameter when it formed, 1.85 billion years ago.

Deccan Traps - The Deccan structure, located at 75°E, 20°N, covers a large part of west-central India. About sixty-five million years ago huge lava flows formed a thick, roughly circular area of approximately 520,000 square kilometers.

Barringer (Meteor) Crater - The Barringer Crater is a circular hole in the ground in northern Arizona, 35°N, 111°W. It is 1.2 km in diameter. Many pieces of iron meteorite have been found scattered around the crater. It is estimated to have formed 49,000 years ago.

Lesson 14 — Direct Hit at the K-T Boundary

Activity B: Global Ecological Disaster

Objective

Students will:

- visualize or physically demonstrate simulations of some of the effects of a huge impact.

Background

National Geographic Sept. 1986. See Background from Lesson 14, Activity A (pgs. 14.2-14.5).

Procedure

Advanced Preparation

1. Gather materials.
2. Review background material.

Classroom Procedure

Atmospheric Changes (see diagram)

1. Put water in each bottle to a depth of 1 cm.
2. Place a stopper in each bottle, insert one thermometer through each stopper.
3. Place the two prepared chambers where all students may observe.
4. Distribute the Atmospheric Changes Data Sheet.
5. Have the students predict what will be the effect of sunlight on the chambers if one chamber contains smoke particles.

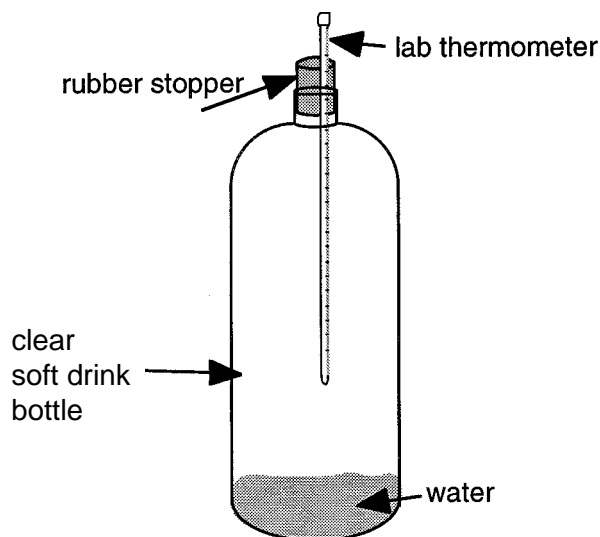

About This Activity

In this activity students will use simple simulations to develop a better understanding of the short term and long term changes that happen when gigantic impacts occur on Earth. These exercises may be done as demonstrations, experiments or as verbal visualizations, i.e. “Think about what happens when you throw a large rock in a puddle!”.

Materials for Activity B

- 2 two liter clear soft drink bottles
- 2 one hole rubber stoppers or styrofoam or clay to block top
- 2 lab thermometers (*long*)
- water
- paper (*wooden splints work well also*)
- matches
- light source (*sunlight is best but lamp or overhead will work*)
- Atmospheric Changes Data Sheet for temperature and time (*pg. 14.16*)
- two pie pans
- rock or other object 3-5 cm diameter
- water to fill pan
- flour to fill pan
- pencil/pen

6. Put burning paper (splint or wooden stir stick) in one chamber and immediately replace stopper (this may be done before students are present).
7. Allow time for the temperature to come down to the **same temperature** as in the control container.
8. Place chambers in sunlight (or use lamp if necessary).
9. Using data table, students record temperature of each chamber at 1 minute intervals or more, allowing enough time to show a significant difference in temperature).
10. Based on the results, students should evaluate their hypotheses.

Tsunami

1. Fill one pie pan with water.
2. Drop rock in water.
3. Observe what happens.
4. Compare and contrast the effect of the “rock” to the possible effect of an asteroid over 10 km in diameter with an impact speed of about 15 km per second.

Ejecta and Base Blast

1. Fill one pie pan with flour.
2. Drop rock or large heavy object into flour (layered with another fine powder if desired).
3. Observe the ejecta and fall out.
4. Discuss the probable similarities and differences between this demonstration and what happened at the impact site at Chicxulub.

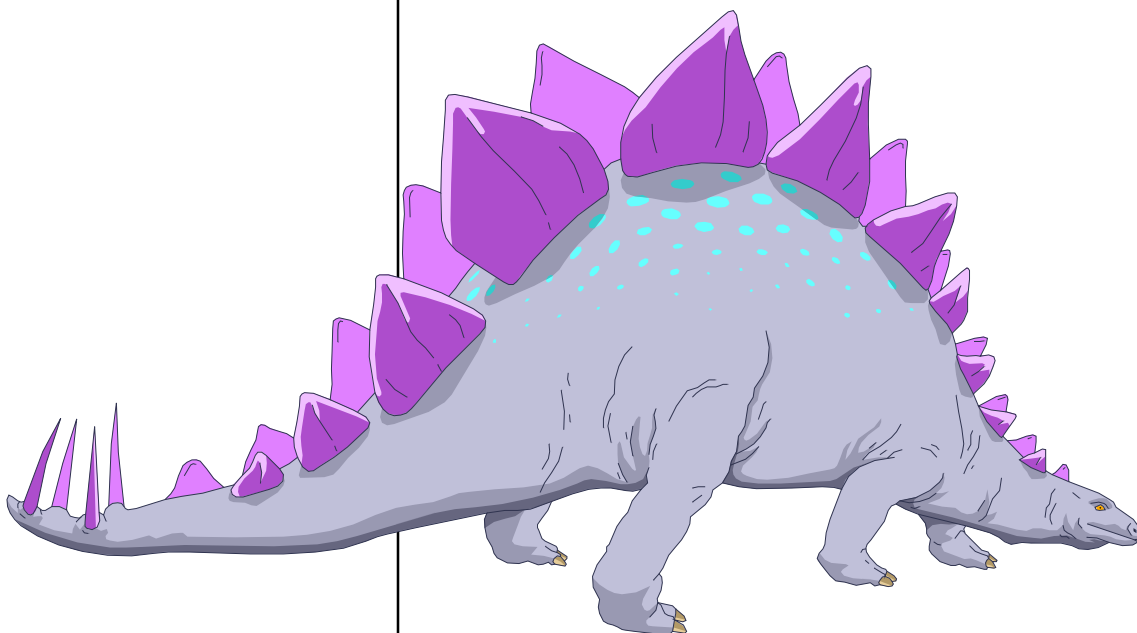

Lesson 14 — Direct Hit at the K-T Boundary

Activity C: You Were There!

Objective

Students will:

- write and illustrate a point of view narrative on the extinction of the dinosaurs.

Background

Consult the Background in Lesson 14, Activity A (pgs. 14.2-14.5).

Procedure

The time is sixty-five million years ago. A huge meteorite has hit the Earth. Imagine that you are a dinosaur and you notice things seem different!

Write a paper from the point of view of your dinosaur.
How do you feel? How is your environment changing?

Make an illustration to accompany your paper.

About This Activity

Students will write and illustrate a narrative from the point of view of dinosaurs as a meteorite struck the Earth sixty-five million years ago.

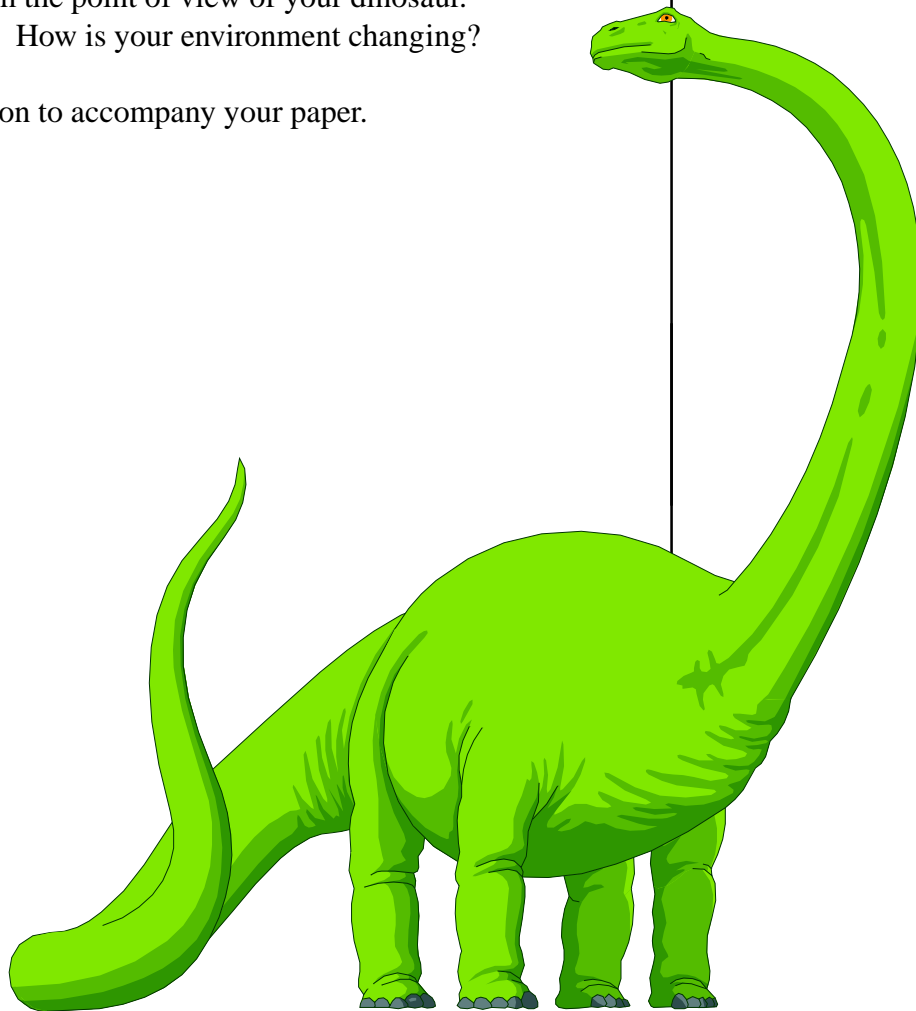

Atmospheric Changes Data Sheet

Describe lab setup.

What will happen to the temperature in the chamber containing smoke particles?

Chamber	Starting Temperature <i>(chambers must be equal)</i>	Time _____ <i>Record Temp Below</i>	Time _____ <i>Record Temp Below</i>	Time _____ <i>Record Temp Below</i>	Time _____ <i>Record Temp Below</i>
# 1					
# 2					

What happened in the chambers and why?

“What effect do they have?”

Objectives

Students will:

- read about large historical meteors and meteorite falls.
- discuss the effects the impacts have had on people.
- compare the responses recorded in history to their own responses.

Background

Part A: The Tunguska Meteor. This reading describes the largest meteor and explosion in recorded history. Many effects of its explosion were like those of very large meteorite impacts. Yet, there is no agreement on what type of planetary material exploded in the Earth’s atmosphere to cause these effects.

Part B: The Ensisheim Meteorite. The story of the fall of the Ensisheim Meteorite focuses on how people reacted to a large meteorite fall in the year 1492.

Part C: Fall of the Sikhote-Alin Meteorite. This reading selection describes one of the largest meteorite showers in recorded history. The primary emphasis is on the physical events of the fall, with a secondary emphasis on the political context of the strategically sensitive area where the fall occurred.

Part D: The Peekskill Fall.

The story of the Peekskill fall, like that of Noblesville in Lesson 1, is a story of ordinary people in the 1990s. This meteorite crashed into a teenager’s car after the blazing meteor had been seen by many fans watching football games.

Part E: The Fall of Allende.

This reading describes a large meteorite shower and the subsequent scientific revolution. Allende is a special type of meteorite that generated extra excitement because it was studied by a large number of scientists testing their equipment in preparation for the imminent arrival of the Apollo Moon rocks. They discovered that this meteorite revealed new information about the early history of the solar system.

About This Lesson

This lesson contains five reading selections and associated questions. The readings and questions are mostly about the responses of people to meteor and meteorite falls.

Materials

- copies of readings (pgs. 15.3-15.12)
- reference materials
- writing materials
- maps

Procedure

Give attached readings to students to read and discuss. Have students locate each event site on a map.

Vocabulary

asteroid, meteorite, meteor, crater, comet, expedition, superstition, fireball

Teacher Key - Questions

Part A: The Tunguska Meteor

1. Why would an explosion blow down trees all around it?
2. Why might the trees nearest the explosion site still be standing?
3. Why might the Russian Academy of Sciences have waited 19 years to make an expedition to the Tunguska site? (**World War I, the Russian Revolution**)
4. How might the world react today to a Tunguska-type explosion at the same place? What if it happened in Texas?
5. What could you do today to find sand-sized grains from the asteroid or comet that hit at Tunguska? What types of material might have survived 85 years of weather? (**Metal, minerals**) The sand-sized grains from the meteor might have been propelled by the explosion; where might you find this sand separate from locally generated sand? Might any Tunguska material be preserved anywhere else?

Part B: The Ensisheim Meteorite

1. How large was the stone, if its density was 3 grams per cubic centimeter? (**About the size of a cube 40 cm on an edge.**) How would you get a stone that heavy out of a hole in the ground?
2. After they found the stone, why do you suppose the townspeople argued? Why might the townspeople have thought the stone was good luck? What would you have thought?
3. Why didn't the person who owned the field claim the stone as his own? (**This is a difficult question. The concept of property ownership that we now accept was not known in 1492. Farmland around a village was considered "common land," to be used by the whole village.**)
4. Why might the mayor have taken the stone to the Church? Why didn't he take it inside the church? If a meteorite landed near your town, where would it be taken, or would it be moved at all?
5. Why was King Maximilian interested in the fall of the Ensisheim meteorite?
6. What other event happened in the year 1492?

Part C: Fall of the Sikhote-Alin Meteorite

1. Where is Sikhote-Alin? Locate the area on a globe or a map. The towns nearest to the meteorite fall are Dainerecensk and Vostrecovo. Can you find these on a map? (**45.8°N, 134-135°E**)
2. Why might people not have rushed out immediately to find the meteorites?
3. Russia and Japan were fighting during World War II, just a few years before the Sikhote-Alin meteorite fall. What might people have thought about the fall if it had happened during the war?

4. China and the United States were fighting all across Korea during the Korean conflict, just a few years after the Sikhote-Alin meteorite fall. What might people have thought about the fall if it had happened during that conflict?

Part D: The Peekskill Fall

1. Why would someone want to buy a meteorite?
2. Compare how the people in Peekskill responded to a meteorite fall with how those in Ensisheim responded five hundred years earlier.
3. How does the geography of the Earth affect how many meteorites are found?
4. How do you think population density affects recovery rates of meteorite falls?
5. Using the many videos of the meteor streak, how could you determine the direction of flight and the speed of the meteor?

Part E: The Fall of Allende

1. In February 1969, many scientists:
 - a. **had developed ways to study moon rocks, but didn't have any samples yet.**
 - b. were studying lunar samples that had been brought back from the moon the previous summer.
 - c. believed that life existed on the Moon.
 - d. were in Pueblito de Allende when the meteorite shower occurred.
2. In this passage, it seems:
 - a. seeing a fireball in the sky in central Mexico is a normal event.
 - b. Pueblito de Allende is a large, busy town.
 - c. **meteorite fragments are interesting to villagers and farmers as well as scientists.**
 - d. after several days, people lost interest in the meteorite fragments.
3. The statement "The meteorite proved to be most unusual." means:
 - a. the meteorite was average.
 - b. the scientists did not like the meteorite.
 - c. **the meteorite was special.**
 - d. the meteorite was from the Moon.
4. Which of these statements best summarizes the passage?
 - a. **The Allende meteorite shower gave scientists a very unusual meteorite to study and an opportunity to practice using labs and procedures that would be used later with the lunar samples.**
 - b. The Mexican government was very cooperative as scientists looked for meteorites in 1969.
 - c. Although meteoriticists were very interested in the Allende shower in early 1969, they soon turned their attention to the lunar samples and forgot this wonderful event and the important information it revealed.
 - d. The Allende meteorite shower was an important scientific event because it happened near NASA JSC.

Lesson 15 — Historical Meteorite Falls
Part A: The Tunguska Meteor

The biggest meteor in recorded history shot across the Tunguska River in Russia in 1908, and exploded like a nuclear bomb. The Tunguska meteor did not make an impact crater, but some of the effects of its explosion are similar to what could happen in a large meteorite impact.

At seven in the morning on June 30, 1908, a blazing meteor streaked across the sky in central Russia. It sped northwest from Lake Baikal toward the trading post of Baikit in central Siberia, an area of dense forests, wide swamps, and meandering rivers. Before reaching Baikit, the meteor exploded in a gigantic column of fire near the Tunguska River (61°N, 101.5°E).

The effects of the explosion were felt worldwide. Around the globe scientists wondered at the rapid changes in atmospheric pressure and unusual vibrations in the Earth. People within a thousand kilometers of the explosion saw both the meteor and the fire column. They also heard the explosion like a series of bombs. Closer to the explosion, people felt the ground rumble and shake. At about a hundred kilometers from the explosion, people, animals and houses were scorched and thrown by a hot blast of air. Only a few people were nearer to the blast, and they reported fires, houses being blown down and burnt, and reindeer being killed by falling trees. For 20 kilometers around the center of the explosion, the forest was flattened, with the downed trees pointing away from the explosion. At the center of the blown down area, tree trunks still stood, but all their limbs had been stripped off. Everything was



Courtesy of the Smithsonian Institution.

scorched from the heat.

The Tunguska meteor and explosion were widely reported in newspapers and magazines. However, there was little scientific interest until 1927, when the Russian Academy of Sciences organized an expedition to map the area and find meteorites. The expedition had to battle deep swamps, thick forests, and

hungry insects. Almost 20 years had passed since the explosion, and the explorers were not sure what would be left. At the explosion site, they found the blown down tree trunks and traces of fire among the new growth that had developed during those years. The explorers did not find meteorite craters, but guessed that some bogs were the remains of craters. After working very hard to drain and dig out the most promising bogs, they found no meteorites at all and finally realized that bogs were common all over the region, not only near the explosion. Later expeditions found tiny traces of melted rock in the soil, but never any meteorites.

Scientists have debated for years about what hit the Earth at Tunguska in 1908, especially since it left no meteorites behind. Some people have claimed that an alien spacecraft or a black hole hit the Earth. Most scientists think it was a comet because comets are made mostly of ice and would leave no meteorites. But it may have been a small rocky asteroid, which completely exploded in the air so that no rocks were left. Now, over 85 years later, it may be impossible to learn any more about the Earth's largest meteor explosion in modern history.

Questions

1. Why would an explosion blow down trees all around it?
2. Why might the trees nearest the explosion site still be standing?
3. Why might the Russian Academy of Sciences have waited 19 years to make an expedition to the Tunguska site?
4. How might the world today react to a Tunguska-type explosion at the same place? What if it happened in Texas?
5. What could you do today to find sand-sized grains from the asteroid or comet that hit at Tunguska? What types of material might have survived 85 years of weather? The sand-sized grains from the meteor might have been propelled by the explosion; where might you find this sand separate from indigenous sand? Might any Tunguska material be preserved anywhere else?

Lesson 15 — Historical Meteorite Falls
Part B: The Ensisheim Meteorite

In early November of 1492, the people of central France were astonished to hear a thunderclap from a clear sky rumble across their hills and farms. Today, a sound like that would probably be ignored as an airplane’s sonic boom or an industrial accident. But no one in 1492 had ever heard such a loud explosion. They must have thought it was a “sign.”

As the sound of the thunderclap died out, the people searched for its cause and meaning. Their world was apparently unchanged, except in the small town of Ensisheim, near the border of what are now France and Germany. There, a young boy saw a very large stone fall from the sky and land in a wheat field. He must have told his parents, and a crowd soon gathered where the stone had fallen. It sat at the bottom of a hole, one meter deep in the field. After arguing about what to do, the crowd finally pulled the 150 kilogram stone out of its hole and began breaking pieces off for good-luck charms. The mayor ordered them to stop and had the stone carried into the town and placed in front of the church.

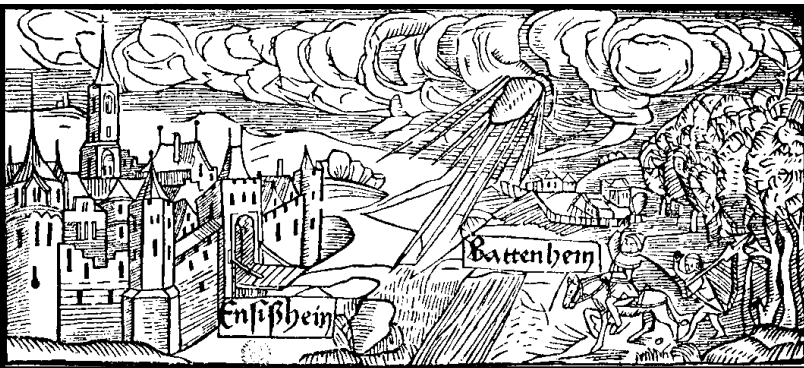

Brant, 1492; courtesy of Zentralbibliothek, Zurich.

News of this marvelous stone traveled quickly to King Maximilian of Austria, heir to the Holy Roman Empire. He arrived in Ensisheim two weeks later, on his way to battle with the French. The King examined the stone, consulted with his advisors,

and decided that it was a sign from God foretelling victory in his upcoming battles. After taking his own piece of the stone from Heaven, the King ordered that it be kept forever in the town church. King Maximilian and his soldiers then marched off to battle and managed to defeat a much larger French army in the battle of Salins. The stone was preserved in the Ensisheim church, where it hangs today. The stone from Heaven got as much credit for the victory as did Maximilian.

Questions

1. How large was the stone, if its density was 3 grams per cubic centimeter?
How would you get a stone that heavy out of a hole in the ground?
2. After they found the stone, why do you suppose the townspeople argued?
Why might the townspeople have thought the stone was good luck? What would you have thought?
3. Why didn't the person who owned the field claim the stone as his own?
4. Why might the mayor have taken the stone to the Church? Why didn't he take it inside the church? If a meteorite landed near your town, where would it be taken, or would it be moved at all?
5. Why was King Maximilian interested in the fall of the Ensisheim meteorite?
6. What other event happened in the year 1492?

Lesson 15 — Historical Meteorite Falls

**Part C: The Fall of the Sikhote-Alin
Meteorite**

An area of Russia called the Sikhote-Alin hills, north of Vladivostok along the Sea of Japan, was enjoying a quiet, cold morning in February, 1947. Although Sikhote-Alin lies next to China and near Japan, two of Russia's traditional enemies, all was peaceful in 1947. World War II had ended a year and a half earlier, and the Korean conflict was years in the future. The few people in Sikhote-Alin went about their business, mostly surviving the long winter and preparing for spring.

At 10:30 in the morning on February 12, the mid-morning calm was shattered as a huge red and yellow meteor streaked across the sky. The fireball, with its trail of smoke and sparks, was visible for more than 300 kilometers. As it roared over the hills, it broke apart with a thunderous explosion, and the burning fragments flew downward and crashed into the forest.

Apparently no one rushed to investigate the fall. The next day two airmen discovered where the meteorite had landed when they happened to fly over the site. Where there had been unbroken forest, the airmen saw downed trees, craters, and open clearings. The airmen reported what they had seen to the Soviet government, and a scientific expedition was organized immediately. After slogging through the dense forest, the expedition arrived at the fall site on February 24, 1947.

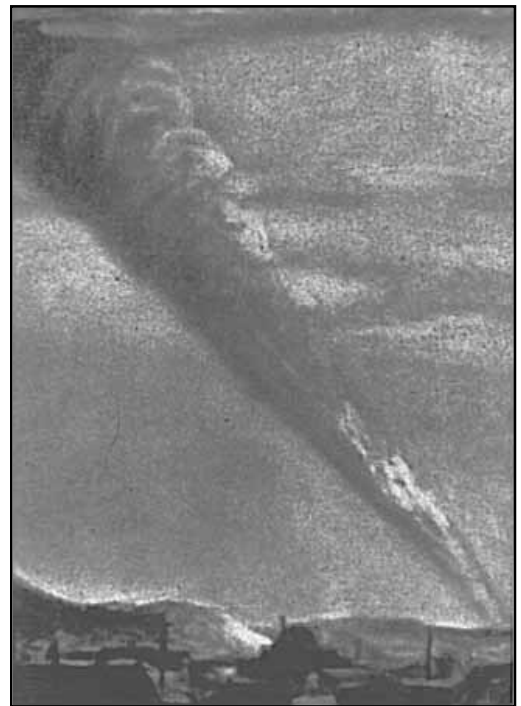

There, scientists found more than 100 holes and craters in the rocky soil. The largest crater was 26 meters across and 6 meters deep; in the crater were many pieces of iron meteorite, together weighing 150 kilograms. The force of the meteorite's impact had twisted the meteorite pieces like taffy candy, blasted trees apart, and thrown rocks a kilometer from the crater. More than 23,000 kilograms of meteorites were found, equal to an iron ball 1.6 meters in diameter.

Questions

1. Where is Sikhote-Alin? Locate the area on a globe or a map. The towns nearest to the meteorite fall are Dainerecensk and Vostrecovo. Can you find these on a map?
2. Why might people not have rushed out immediately to find the meteorites?
3. Russia and Japan were fighting during World War II, just a few years before the Sikhote-Alin meteorite fall? What might people have thought about the fall if it had happened during the war?
4. China and the United States were fighting all across Korea during the Korean conflict, just a few years after the Sikhote-Alin meteorite fall. What might people have thought about the fall if it had happened during that conflict?

Lesson 15 — Historical Meteorite Falls

Part D: The Peekskill Fall

Crash! Boom! Pow!

No, it wasn't Batman, Superman or an automobile accident. Michelle Knapp, a typical eighteen year old high school senior from Peekskill, NY, was home watching television at 7:50 Friday evening October 9, 1992, when she heard a loud crash. She rushed out of her house to investigate and found that her 1980 red Malibu had a demolished trunk.

In other parts of eastern United States, video cameras that had been focused on high school football games shifted upward and caught glimpses of an object streaking across the night sky. Later that evening, local television stations broadcast the videos of this spectacular meteor. Once a meteor makes it through the Earth's atmosphere and strikes the ground, it is called a meteorite.

Under her mangled car, Michelle found a 11.8 kg, football-sized rock from space. The first clue that suggested this rock might be a meteorite was the melted appearance of the front or leading edge. This exterior texture, called fusion crust, is produced by the friction of the speeding meteorite with the atmosphere. When Michelle touched the rock it was still warm, another good clue. The rock fell with such a great force that the red paint from the car was imbedded in the meteorite. Also, after passing through the car's trunk, the rock made a 15 cm deep crater in the driveway.

The Peekskill Police Department transported the meteorite to the American Museum of Natural History in Manhattan to be classified. Scientists identified it as an ordinary chondrite, the most common type of meteorite found. Meteorite falls are



Credit: Dr. Dimitri Mihalas, courtesy of Science Graphics.

a regular occurrence; thousands of kilograms are distributed onto Earth's surface each year. Even so, the odds against a meteorite hitting Michelle's car were extremely high. There have only been a few recorded instances of meteorites striking anything but the ground or the ocean. A dog was reportedly killed in Egypt in 1911 by the impact of a meteorite. In Alabama a meteorite passed through the roof of a house and injured a woman.

The Peekskill meteorite sold for about \$ 69,000. What about Michelle's car? Would insurance cover it? Would you believe someone bought it for \$10,000 so they could put it on display?

Questions

1. Why would someone want to buy a meteorite?
2. Compare how the people in Peekskill responded to a meteorite fall with how those in Ensisheim responded five hundred years earlier.
3. How does the geography of the Earth affect how many meteorites are found?
4. How do you think population density affects recovery rates of meteorite falls?
5. Using the many videos of the meteor streak, how could you determine the direction of flight and the speed of the meteor?

Part E: The Fall of Allende

The Allende Meteorite Shower — A Scientific Revolution

Early on the morning of February 8, 1969, the peaceful sleep of villagers in central Mexico was disturbed by a brilliant fireball and loud explosions. The fireball came from the south-southwest and scattered thousands of meteorite fragments over a huge area around the town of Pueblito de Allende. The villagers and farmers collected many pieces of meteorite. One of the pieces was taken to the nearest city and reported in the newspaper. Within days scientists from NASA and the Smithsonian Institution were at the site in Mexico, collecting specimens and describing their distribution. Over the following months many other collectors visited the area. Altogether the Mexican and foreign collectors recovered thousands of fragments weighing a total of 1,000 kg!

The earliest samples collected by U.S. meteoriticists were rapidly distributed to many other scientists who were preparing their labs for the imminent return of Apollo lunar samples. The scientists welcomed the chance to study a new meteorite and test their new procedures. The meteorite proved to be anything but ordinary. It was a very primitive carbonaceous chondrite containing evidence of the earliest history of the solar system. This special meteorite fell at the right place and the right time. The right place was in Mexico only a day's drive from NASA's Johnson Space Center in Houston. The right time was early 1969, five months before the return of the first Apollo Moon rocks. The information about the early solar system revealed in the Allende meteorite created a revolution in meteorite science that is still felt today.



Questions

1. In February 1969, many scientists:
 - a. had developed ways to study moon rocks, but didn't have any samples yet.
 - b. were studying lunar samples that had been brought back from the moon the previous summer.
 - c. believed that life existed on the Moon.
 - d. were in Pueblito de Allende when the meteorite shower occurred.

2. In this passage, it seems:
 - a. seeing a fireball in the sky in central Mexico is a normal event.
 - b. Pueblito de Allende is a large, busy town.
 - c. meteorite fragments are interesting to villagers and farmers as well as scientists.
 - d. after several days, people lost interest in the meteorite fragments.

3. The statement "The meteorite proved to be most unusual." means:
 - a. the meteorite was average.
 - b. the scientists did not like the meteorite.
 - c. the meteorite was special.
 - d. the meteorite was from the moon.

4. Which of these statements best summarizes the passage?
 - a. The Allende meteorite shower gave scientists a very unusual meteorite to study and an opportunity to practice using labs and procedures that would be used later with the lunar samples.
 - b. The Mexican government was very cooperative as scientists looked for meteorites in 1969.
 - c. Although meteoriticists were very interested in the Allende shower in early 1969, they soon turned their attention to the lunar samples and forgot this wonderful event and the important information it revealed.
 - d. The Allende meteorite shower was an important scientific event because it happened near NASA JSC.

Exploring Meteorite Mysteries
Lesson 16 — Near Miss

Objectives

Students will:

- apply science to daily life as they simulate possible responses to a meteorite impact.
- produce articles for a newspaper.
- role-play in a panel discussion (after they have researched scientific careers).

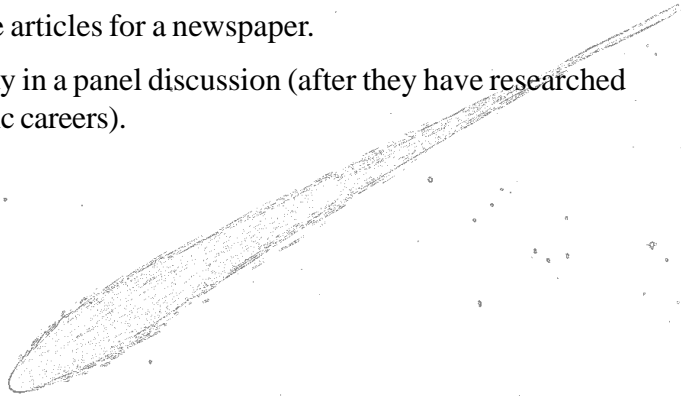

Undetected asteroid streaks perilously close to Earth

by Blaine P. Friedlander

“In May 1993, the Earth survived a near miss by an asteroid. This “projectile” was about 10 meters in diameter and weighed about 5.4 million kilograms — about the mass of a Navy destroyer! A group called Spacewatch in Arizona discovered it after it had passed within 145,000 kilometers of Earth!”

*Adapted from: Houston Chronicle,
Monday, June 21, 1993.*

“What effect do they have?”

About This Lesson

This lesson involves the students in creative interactions by asking them to take on the roles of community members who react to a large and frightening, but not devastating, impact. There are two activities which require different research and modes of response. The students will write newspaper articles from the point of view of a variety of citizens. In preparing for and conducting a community briefing, the students will gain scientific knowledge about meteorite impacts and careers.

Lesson 16 — Near Miss

Activity A: “Extra, Extra, Read All About It!”

About This Activity

Students will read about the recent near miss of an Earth crossing asteroid and about the impact of comet Shoemaker-Levy 9 on Jupiter. They also have heard about the impact that killed the dinosaurs and most other species.

Now students will consider how they and other people would react if an impact occurred near their community. Students will write articles for a newspaper, reflecting the many different reactions of citizens.

Materials for Activity A

- Student Sheet (pg. 16.6)
- paper and pencils
(computer if possible)

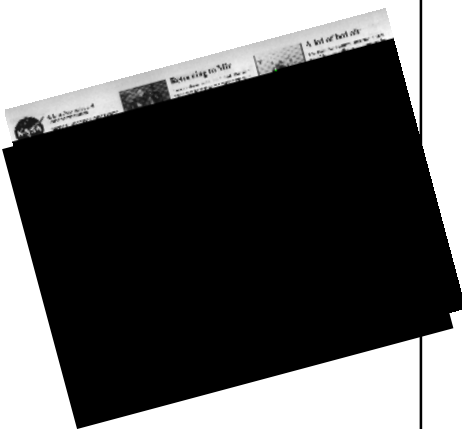

Objective

Students will:

- apply science to daily life as they explore the implications of a fictitious meteorite impact in the vicinity of their community.

Background

From July 16 through July 22, 1994, fragments of Comet Shoemaker-Levy 9 collided with Jupiter, with dramatic effect. This was the first collision of two solar system bodies ever to be predicted and observed. Shoemaker-Levy 9 consisted of at least 20 fragments with diameters estimated at up to 2 kilometers, which impacted the planet at 60 km/sec. The impacts resulted in plumes of gas and dust which rose many thousands of kilometers high, hot “bubbles” of gas in the atmosphere, and large dark “scars” on the atmosphere which lasted for weeks. Even after the main bodies had hit, smaller bits of the comet continued to impact the planet. Shoemaker-Levy 9 is gone now, and Jupiter is getting back to normal. If the comet had hit Earth instead, the effects would have been devastating.

Procedure

Advanced Preparation

1. Reproduce Student Sheet as needed.
2. Review the background information above and the background in Lesson 14, Activity A (pgs. 14.2-14.5), and Lesson 15 (pg. 15.1).

Classroom Procedure

1. Students read background information and newspaper article on Student Sheet.
2. After reading, have the students discuss how they feel about knowing that there are large objects that could someday impact the Earth.
3. Teacher asks, “What if a meteorite landed outside our community and made a crater 30 meters across?”
4. Students discuss the question from different viewpoints. Teacher leads the discussion to different professions.
5. Students write a newspaper article from the viewpoint of different professionals.

Activity B: Take My Advice

Objectives

Students will:

- evaluate implications of scientific principles and the findings of research.
- recognize that the scientific community has a vast amount of information about meteorites and is aware of the hazards associated with meteorite falls.

Background

Just as technology has provided a wide margin of safety from hurricanes (through early detection and warning), earthquakes (through fault detection and architectural modifications), and other natural disasters, scientists continue to watch for Earth-crossing asteroids and meteors. They study possible diversion and/or destruction of the potentially dangerous ones.

NASA's "Spacewatch" is one asteroid detection system which has been placed "on line." In addition to detection, scientists have created a number of crisis scenarios to consider how they would deal with a threatened impact in the future. Some possible actions to respond to an impact crisis have been developed. Suggested strategies include exploding or diverting the incoming body. The technology necessary for implementing many of these defensive maneuvers is available today. One important element necessary to developing a defense against any global threat is cooperation. Scientists have traditionally exhibited a willingness to cooperate with colleagues worldwide and governments can follow their example.

Dr. Hy "Rocky" Mountain
Geologist

Dr. Susan Starr
Astronomer

Dr. Mattie R. Wright
Meteoriticist

Col. Cathy "Crash" Carlston
Test Pilot

Major Ian Laser
Long-Range Weapons Specialist

Secretary Lyons
Secretary of Defense

Representative B. Noble
Congressional Delegate from Texas

About This Activity

The activity starts with a "simulated" meteorite impact outside the community. This may follow Activity A or stand alone. Students take on the roles of concerned citizens and "experts" as they conduct a town meeting held to address their questions and concerns about the event and government plans for safeguarding their community from larger impacts. Students will need to research information for the panel discussion. If the class has completed many of the lessons on meteorites and asteroids, this activity could be used as an assessment of the knowledge gained by the students.

Materials for Activity B

- question cards
- fact cards
- name placards for panel members on left

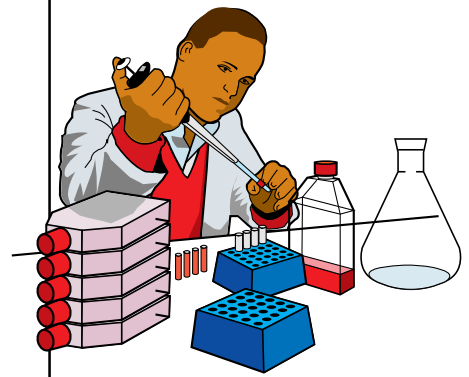

Question: How will the scientific community keep citizens informed if there is a real impact crisis?

Expert: Dr. Susan Starr or Secretary Lyons

Question: Do you know what's going to happen if an asteroid hits us?

Expert: Dr. Hy "Rocky" Mountain, Geologist or Dr. Mattie R. Wright, Meteoriticist

Information: Earth-crossing asteroids are made of stony material, or metal. We know this from studies of meteorites and spectral reflectance studies of asteroids.

Expert:
Dr. Mattie R. Wright, Meteoriticist or Dr. Susan Starr, Astronomer

Procedure

Advanced Preparation

1. Assemble background information.
2. Gather or identify research materials for questions and facts.

Classroom Procedure

1. Introduce the topic and provide the background necessary to establish a plausible non-threatening, yet alarming impact event (see Activity A).
2. All students research the topic and prepare for the town meeting. Each will produce fact cards or information "crib sheets" for the expert of their choice. Each will develop questions that will challenge the experts and inform their community. Allow students to see the cards above.
3. Set up the town hall meeting. Panel members may be chosen at random, by the teacher, the class, or by trying out for the teacher.
4. Read the following to the class: "Our class is going to act out a nationally televised "town meeting." It will be conducted to answer questions, allay fears, and develop community input for an emergency plan to respond to the approach of a large meteor and its impending fall. Our panel members will represent science advisory and governmental officials. The audience has question cards, but anyone may ask questions. Panel members may refer to their fact cards when questioned, but remember that even the experts don't have all the answers. Just do your best." (The teacher will act as panel moderator.)
5. Panel moderator starts the meeting with the statement: "There is concern that just as meteorite falls have caused destruction in the past, such as the Tunguska Fall of 1908, future meteorites could also pose a danger to life on Earth. The purpose of this meeting is to answer questions from the public about the threat of possible asteroid, comet or meteorite impacts, and to gather input for an emergency plan. We have assembled a panel of experts who have been studying about asteroids, impacts, and the possible defenses against potentially dangerous meteors, both before and after they actually strike the Earth. I will now call for a question from the audience."
6. Panel moderator ends the meeting with several summarizing statements.

Undetected asteroid streaks perilously close to Earth

by Blaine P. Friedlander

“In May 1993, the Earth survived a near miss by an asteroid. This “projectile” was about 10 meters in diameter and weighed about 5.4 million kilograms — about the mass of a Navy destroyer! A group called Spacewatch in Arizona discovered it after it had passed within 145,000 kilometers of Earth!”

*Adapted from: Houston Chronicle,
Monday, June 21, 1993.*

Background

From July 16 through July 22, 1994, fragments of Comet Shoemaker-Levy 9 collided with Jupiter, with dramatic effect. This was the first collision of two solar system bodies ever to be predicted and observed. Shoemaker-Levy 9 consisted of at least 20 fragments with diameters estimated at up to 2 kilometers, which impacted the planet at 60 km/sec. The impacts resulted in plumes of gas and dust which rose many thousands of kilometers high, hot “bubbles” of gas in the atmosphere, and large dark “scars” on the atmosphere which lasted for weeks. Even after the main bodies had hit, smaller bits of the comet continued to impact the planet. Shoemaker-Levy 9 is gone now, and Jupiter is getting back to normal. If the comet had hit Earth instead, the effects would have been devastating.

“How
can I use
them?”

Objectives

Students will:

- actively explore the potential resources available to space travelers through research, assessment, team cooperation, and exploration simulations.
- develop the background to make the connection between meteorite research and potential planetary resources.
- map and core an edible asteroid.

Background — What can we get from an asteroid?

Two types of materials on asteroids appear to be attractive for mining - metals and volatiles. Both of these are essential for space travel. The cost of launching any material from the Earth is extremely high, so useful materials which are already in space can be very valuable.

Most of the asteroids are found in orbits between Mars and Jupiter. However, several hundred have orbits that bring them close to the Earth. Rocket trips to some of these “near-Earth” asteroids would use even less fuel than a trip to the Moon, though the travel time to an asteroid might be much longer.

Metals - An asteroid of the composition of an ordinary chondrite could be processed to provide very pure iron and nickel. Valuable byproducts would include cobalt, platinum, gallium, germanium, and gold. These metals are basic to the production of steel and electronic equipment. Some metals from an asteroid mine might even prove valuable enough to be returned to Earth. Iron meteorites are high grade ores.

Volatiles - Water, oxygen, and carbon compounds are useful in any space settlement, both for life support and for producing rocket fuel. These volatiles could be found in an asteroid that resembles a carbonaceous chondrite or the nucleus of a former comet. Water contents may range from 5-10% by weight for a chondrite to 60% by weight for a comet nucleus. In some asteroids large quantities of sulfur, chlorine and nitrogen may also be available.

About This Lesson

In teams, students will research and document some of the requirements for mounting an expedition to an asteroid. Activity B allows the students to simulate a miniature mining expedition of an edible asteroid.

(Adapted from “Asteroid Resources” by John S. Lewis in Space Resources, NASA SP-509, Vol. 3, pg. 59-78, 1992)



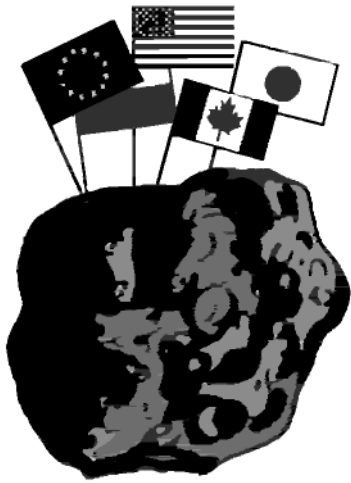

About This Activity

This is a group-participation simulation based on the premise that water and other resources from the asteroid belt are required for deep space exploration. The class will brainstorm or investigate to identify useful resources, including water, that might be found on an asteroid. Teams of students are asked to take responsibility for planning various aspects of an asteroid prospecting expedition, and to present the results of their planning.

The students should learn that a large project requires the cooperation of many different teams, considering many ideas and needs. Elementary level classes could focus on the simplest aspects of vehicle design, hardware and personnel; advanced level classes could also consider financing for the mission, criteria for crew selection, Earth support teams, training, and maintenance, etc.

Lesson 17 — Asteroid Resources

Activity A: Exploration Proposal

Objectives

Students will:

- plan an expedition or other large engineering project.
- investigate options in many aspects of space flight.
- present their options, reasoning, and recommendations to the group.

Scenario

Time: Sometime in the next century.

Place: Earth.

NASA, in cooperation with national and international space agencies, is planning for human exploration of the outer solar system. The intention is to send expeditions to the moons of Jupiter, Saturn, Uranus, and Neptune to explore, collect samples, and search for clues to the beginnings of the solar system. It is impractical to send all the rocket fuel and consumables (drinking water, air, food) from the Earth because they are heavy, bulky items. Therefore, NASA is looking for sources of rocket fuel and consumables at an intermediate destination, the asteroid belt. Your class has been selected to plan a prospecting expedition to the asteroids to look for resources that could be turned into rocket fuel, drinking water, etc.

Materials for Activity A

- resource materials about: space travel, space resources, asteroids, rockets, space shuttle, spacecraft
(see *Education Resources*, pg. B.2)
- personal log (*journal*)
- art supplies
- Student Background sheet (pg. 17.7)

Procedures

Advanced Preparation

1. Read background material.
2. Assemble research materials or know where students may find them.
3. Copy Student Background sheets as needed.

Classroom Procedure

1. Present background for the problem, and then brainstorm what facts about asteroids might be needed to prepare for a mission that would prospect for water, oxygen, or metals.
2. Brainstorm the important components that must be designed or built to mount a prospecting expedition to an asteroid. Topics to be addressed may vary, depending upon the grade levels of students, availability of information and materials, etc. They could include: propulsion (type of rocket), power, life support, communications, financing (including valuable things that could be mined on an asteroid and returned to Earth), crew selection (including human vs. robotic), ground support, vehicle design, maintenance, prospecting tools, and training.
3. Each team selects a topic from those suggested — all members of the team should reach consensus.
4. Teams will research and document their topic, keeping a log of sources investigated, relevant data found, relevant conversations, meetings, etc. The research should include a “major points” outline, visual aids, references used, and list of possible problems to be resolved through research. Teams should also list “interfaces” with other aspects of the expedition design, (e.g., the electrical power team needs to know how large the crew is, how the life-support system runs, and whether the prospecting tools require electricity).
5. Team results should include the basic questions or trade-offs for their part of the prospecting expedition, advantages and disadvantages for each option (e.g., power from solar cells versus power from a nuclear reactor), and a recommendation of which option is best for the expedition. Groups should present their results to the class.

Questions

1. Why do humans explore?
2. Where does the money for space exploration come from?
3. Might the money be spent better on the many problems on Earth?
4. What are possible economic benefits of space exploration?
5. Might a lunar base be cheaper to run than a space station in low-Earth orbit?
6. What are the advantages/disadvantages of gender-mixed crews?
7. What are the different abilities of human crews and robotic instruments (e.g. compare initiative, adaptability, hardiness, need for life-support)?
8. What types of support teams (on Earth or other home base) are necessary to a mission? Consider human and/or robotic crews.
9. How does destination and crew selection affect vehicle design?
10. What skills/programming would astronauts/robots need during each phase of a mission?
11. Imagine some emergencies that might occur in flight. How might we plan to deal with them? What kinds of problems could not be fixed in a spacecraft millions of miles from home base?

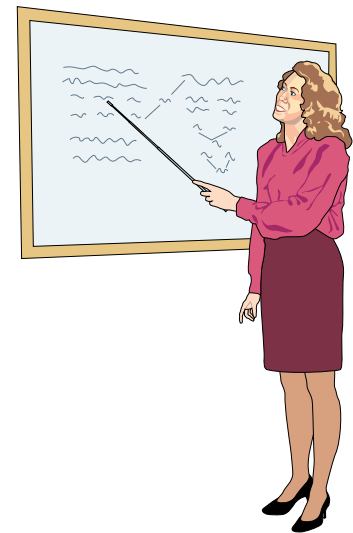

Extensions

1. Create a web showing the interconnections of support personnel necessary to a mission.
2. Research and debate “Human vs. Robotic Exploration.”

Activity B: Prospecting on Asteroids

About This Activity

This activity allows students to simulate a miniature mining expedition to an edible asteroid.

Materials for Activity B

This will make one large or two small “asteroids” for about 10 students (*groups may take turns*).

- 1 large package of chocolate sandwich cookies
- 10-20 grapes (*depends on size of grapes*)
- 1 large bag of marshmallows
- 1 stick of margarine
- 40 peanuts (*approximate*)
- 1 large microwaveable bowl
- 2 containers to hold crushed cookies
- 1 heavy glass or other object to crush cookies
- microwave
- spatula
- waxed paper
- refrigerator
- apple corers, knives, or cork borers
- toothpicks
- small tabs for labels
- Student Worksheet (*pg. 17.8*)
- metric ruler
- pens/pencils

Objectives

Students will:

- devise and carry out an investigation plan to prospect for resources on an artificial asteroid.
- use reasoning, observation, and communication skills.
- map an edible asteroid.
- conduct coring or digging excavations to assess and report the “mineral resources” available.

Background

Scientists have found that meteorites contain materials that could be useful to support space travel. Asteroids are the source of many meteorites; therefore, it has been proposed that mines and manufacturing plants on asteroids would be able to supply or replenish needed consumables for deep space expeditions.

Some of the resources include, but are not limited to:

water - found in minerals in carbonaceous chondrites (used for life support or rocket fuel)

diamonds or platinum - found in ureilites (monetary or industrial value)

iron, nickel, cobalt, or gold - found in ordinary chondrites and irons (industrial value)

fine surface materials similar to soils - (for nutrient or plant growth material, insulation, or building blocks)

gallium or germanium - found in ordinary chondrites (used for electronic circuitry)

oxygen - can be extracted from minerals (used for life support and rocket fuel)

carbon - found in carbonaceous chondrites (used for life support and manufacturing)

Procedure

Advanced Preparation

1. If the teacher will be making the “asteroid(s),” allow at least 10 hours of refrigeration before class time (see classroom procedure and recipe on page 17.6).
2. If the class will make the “asteroid(s),” allow two class sessions for this activity.
3. Assemble or assign materials.
4. Review the background material.

Classroom Procedure

Day 1

1. Discuss resources on asteroids; brainstorm the material needs of deep space travelers.
2. Establish and assign tasks (may be based on Activity A or Background Information).
3. Students decide what and why they could prospect on asteroids.
4. Team tasks: make an edible “asteroid”, class or team determines what the ingredients represent (see recipe directions below).

Day 2

5. Exchange “asteroids” with another team (to make the coring a discovery).
6. Name the “asteroid” (see naming criteria in Lesson 4 — The Meteorite-Asteroid Connection).
7. Draw or map the “asteroid” using the student worksheet; illustrate in detail.
8. Locate the best site for a core sample (a deep cylindrical hole) that will help determine the interior resources.
9. Mark the core location on the map, and on the “asteroid,” using a small flag or toothpick.
10. Take one or more core samples using a sharp apple corer or knife.
11. Draw and describe the core on the Student Worksheet, noting the type and amount of “mineral resources” present.
12. Write a brief report to headquarters on Earth, describing the research, findings, and suggestions for further research.

Questions

1. Why would we want to go other places to mine?
2. If the resources of an asteroid are needed to support a deep space exploration mission, where would be a better place from which to launch a resource mining expedition: Earth, a space station, a lunar base, other? Why?

Extensions

1. Create a poster indicating the substances and resources that could be found or produced on different planets, moons, and asteroids. Use information scientists have learned from meteorites and lunar materials.
2. Estimate the cost differences of launching a mining operation from various “jumping off” places.
3. Construct a prototype of a mining facility located on the planetary body of your choice.
4. Set up a booth at a science event to demonstrate your concept for a mining facility.

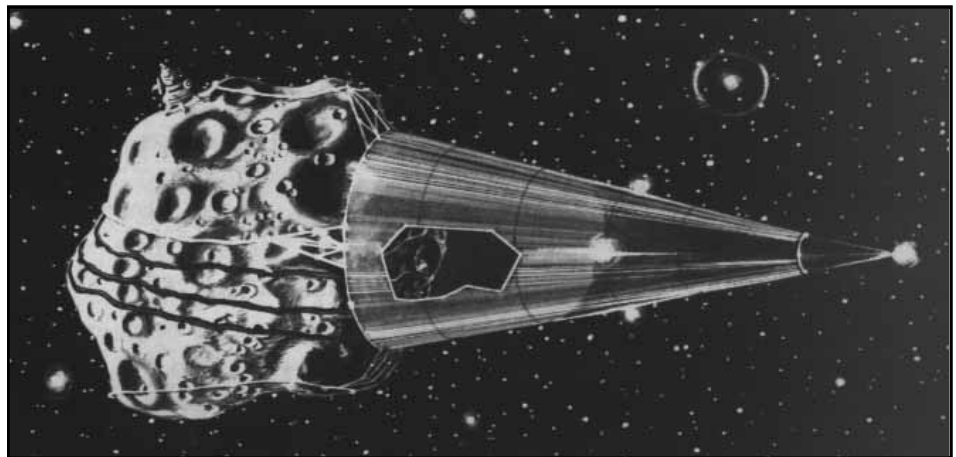

Painting courtesy of Dennis Davidson, American Museum of Natural History, Hayden Planetarium.

Recipe*

See materials list for ingredients

1. Remove filling from approximately 8 cookies, crush cookies into fine particles and set aside on waxed paper for step 7, save filling.
2. Crush remaining cookies (with fillings) into medium-large pieces (add filling from step 1).
3. Mix grapes and peanuts with crushed cookies.
4. Place margarine and marshmallows in microwavable bowl and melt thoroughly, stir.
5. Combine marshmallow mixture with cookie mixture, blend gently but thoroughly.
6. Using lightly buttered hands, gather the gooey mass into an “asteroid” shape, add “impacts” or “collision fragments” by making indentations in the warm mass.
7. While still warm, roll the “asteroid” in crushed chocolate cookies (this creates a regolith or soil-like surface layer), immediately wrap firmly in waxed paper.
8. Refrigerate overnight.

* *For typical asteroid shape and topography, review the picture of asteroid Ida in the slides and below. This recipe will produce a very dark surface, possibly like a “C” class asteroid, which might correspond to carbonaceous chondrite meteorites.*

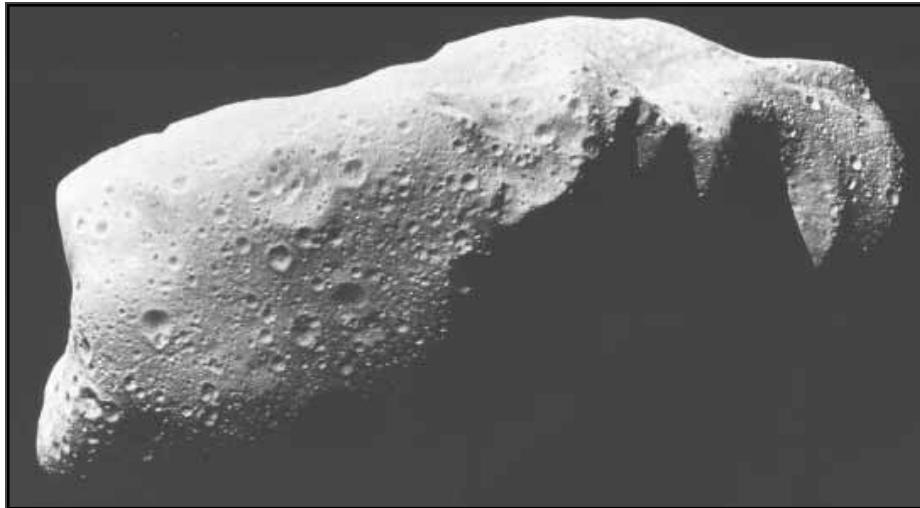

Asteroid Ida

Student Background: Activity A



Scenario

Time: Sometime in the next century.

Place: Earth.

National and international space agencies are cooperating to plan for human exploration of the outer solar system. Their intention is to send expeditions to the moons of Jupiter, Saturn, Uranus, and Neptune to explore, collect samples, and search for clues to the beginnings of the solar system. It is impractical to send all the rocket fuel and consumables (drinking water, air, food) from the Earth because they are heavy, bulky items. Therefore, the space agencies are looking for sources of rocket fuel and consumables at an intermediate destination, the asteroid belt. Your class has been selected to plan a prospecting expedition to the asteroids to look for resources that could be turned into rocket fuel, drinking water, etc.

Background — What can we get from an asteroid?

Two types of materials on asteroids appear to be attractive for mining - metals and volatiles. Both of these are essential for space travel. The cost of launching any material from the Earth is extremely high, so useful materials which are already in space can be very valuable.

Most of the asteroids are found in orbits between Mars and Jupiter. However, several hundred have orbits that bring them close to the Earth. Rocket trips to some of these “near-Earth” asteroids would use even less fuel than a trip to the Moon, though the travel time to an asteroid might be much longer because the asteroid is not orbiting Earth.

Metals - An asteroid of the composition of an ordinary chondrite could be processed to provide very pure iron and nickel. Valuable byproducts would include cobalt, platinum, gallium and germanium. These metals are basic to the production of steel and electronic equipment. Some metals from an asteroid mine might even prove valuable enough to be returned to Earth. Iron meteorites are high grade ores.

Volatiles - Water, oxygen, and carbon compounds are useful in any space settlement, both for life support and for producing rocket fuel. These volatiles could be found in an asteroid that resembles a carbonaceous chondrite or the nucleus of a former comet. Water contents may range from 5-10% by weight for a chondrite to 60% by weight for a comet nucleus. In some asteroids large quantities of sulfur, chlorine and nitrogen may also be available.

(Adapted from “Asteroid Resources” by John S. Lewis in Space Resources, NASA SP-509, Vol. 3, pg. 59-78, 1992)

Lesson 18 — Antarctic Meteorite Teams

“Is there a career for me?”

Objectives

Students will:

- view slides and read about meteorite collecting.
- explore science careers.
- evaluate characteristics and skills of scientific teams dealing with meteorites.
- create scientific teams.
- make written and oral presentations about chosen scientific teams.

Background — Antarctic Meteorite Teams

Antarctica is a special place for collecting meteorites. Since the discovery of nine meteorites on the ice in 1969, over 17,000 fragments of meteorites have been recovered by U.S., Japanese, and European expeditions. Several factors that contribute to this huge number of meteorites are listed below.

- It is easier to find meteorites on ice than on soil or vegetation, so many small meteorites are recovered on the ice.
- The movement of Antarctic ice helps to concentrate meteorites where the ice comes to a rock barrier. This concentration makes it difficult to tell which meteorites are individuals and which are fragments from large meteorite showers. Thus the 17,000 meteorite fragments may come from only 3,000 separate meteorites.
- The ease of collecting large numbers of meteorites led to systematic searches by various national and international groups, which in turn led to discovery of many more meteorites.

The recovery of large numbers of Antarctic meteorites led to an increased interest in studying meteorites in laboratories around the world. Facilities were created where the new meteorites could be classified, distributed and stored. **Meteorite recovery, curation, and research**, is done by teams of scientists working together on a common goal. Each of the teams has a leader, an assistant leader and several workers with different qualifications. Factors that help in the selection of team members are education, experience, special skills and sometimes personality — age, race, and gender are less important.

About This Lesson

This lesson is designed to enhance students’ awareness of scientific career possibilities and requirements. A series of slides will provide students with background information about expeditions to Antarctica to recover meteorites. Meteorite curation and research will be discussed, emphasizing education and skill requirements. After considering potential team candidates, students will work in cooperative groups to create three scientific teams that deal with the recovery, curation, and study of meteorites from Antarctica.

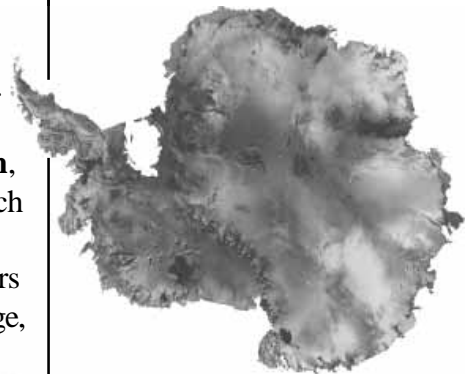

Materials

- ❑ Slide Set, Antarctic Meteorite Teams, projector and screen
- ❑ Student Background reading — Antarctic Meteorite Teams (*pgs. 18.5-18.7*)
- ❑ Member Profiles for Prospective Antarctic Meteorite Teams — Profiles of scientists and other potential team members (*pgs. 18.8-18.9, one for each student*)
- ❑ large sheet of paper and markers to record results, per group

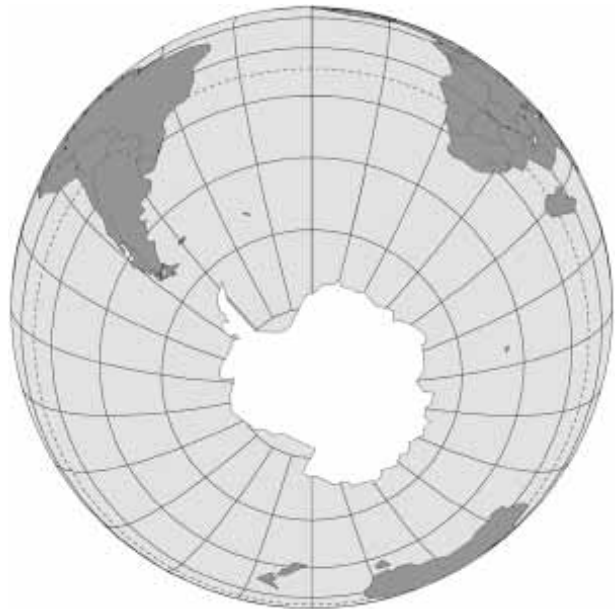

Procedure

Advanced Preparation

1. Assemble materials.
2. Review background.
3. Consider possible options listed in step 3 of Classroom Procedure and the extensions at the end of the lesson — incorporate if desired.
4. Copy Member Profiles and Student Background sheets as needed.

Classroom Procedure

1. Show slide presentation about Antarctic meteorites.
2. Conduct a teacher led discussion or brainstorm session to explore the importance of team members who are skilled and cooperative. (What skills and qualities do Antarctic Meteorite team members require?)
3. Divide students into three or more groups. Distribute Member Profiles and Student Background sheets to each student.

Options:

- Use the profiles as they are listed and give each team a full listing.
- Cut individual profiles into strips and have students draw by separate gender groupings.
- Cut off the number and gender designation on each profile and let students draw slips randomly.
- Have students make up their own profiles.

Note: A profiled person may fit on several different teams (*this really happens*).

4. Each group has the responsibility of creating one of the following teams: **collection**, **curation**, or **research**. There may be more than one team per category. (The teacher may help guide groups to ensure that at least one of each team category is formed.)
5. At some time in the group discussion have each student select a “person” whom they will represent in this activity. Selections are made from the Member Profiles for Prospective Antarctic Meteorite Teams or from profiles created by the students.
6. Groups evaluate team members’ skills and education first. Then decide what team category they will best be able to create as a whole group. Students may make up additional qualifications or skills for any of the profiled people. Consider the years of “experience” and expand on the possibilities. There are many people working in fields not associated directly with their degree(s). Flexibility will be necessary — some individuals may need to move to another group if skills do not match the teams’ needs.

7. Make specific job assignments for each person based on the needs of the team and the individual characteristics and skills. Make up information about the character and abilities of your “person” that will allow them to be better team members. (Individuals might be chosen for more than one team and have different roles on each team.)
8. The groups’ choices and job assignments should be recorded and shared with the class. Groups should be prepared to explain their decisions.

Questions

1. Imagine that you are the organizers of an expedition to collect meteorites.
 - What kinds of personality traits would make the team’s job more enjoyable?
 - What specific items would you include in your plan for transportation, clothing, shelter, food, water, and communication? Explain why you need each item.
 - What would you do in your spare time on the meteorite collecting expedition?
2. What other things, in addition to education, interests and skills, would be important in choosing your meteorite collection, curatorial, or research team? What other things would **not** be important?
3. Would **you** actually want to collect, curate or study meteorites? Explain your answer.

Vocabulary

curation, research, classification, expedition, technician, Bachelor’s Degree, Master’s Degree, Doctor of Philosophy (Ph. D.)

Evaluation

The groups’ lists and explanations could be used as the evaluations of this activity.

Extensions

1. The class could be required to reach a consensus for one set of teams based on the individual group recommendations.
2. Each group could role play the team members and introduce themselves to the class.
3. Each group member could choose a team applicant and write an acceptance/rejection letter explaining the group’s decision.
4. Research other historic Antarctic expeditions and compare them to present day expeditions.

Lesson 18 — Student Background

Meteorite Recovery Team

Collecting meteorites in Antarctica is a difficult and potentially dangerous task. Antarctica is the coldest continent on Earth, with summer temperatures of 0 to -25°C and wind chills that make it feel much colder. Teams work for about two months during Antarctic summer (November to January) in the remote regions along the Transantarctic Mountains. Because meteorites are found long distances from the few scientific bases, teams are transported to camps by air and must have everything they need to survive. They have lots of food and fuel, special clothing and tents for protection, snowmobiles for transportation, and radios for communication.

Team Members — Their Skills, Duties, and Responsibilities

Team Leader and Assistant

- have scientific backgrounds.
- write the proposal for funding and support to the National Science Foundation which operates bases and oversees Antarctic science.
- plan which locations to search for meteorites.
- arrange for transportation and equipment.
- select the other team members and lead the field expedition.

Ice Specialist

- is responsible for finding safe routes on ice and avoiding crevasses.
- manages the mapping project and prepares a computer database of locations of all meteorites.

Team Members (3-4)

- are scientists or science students selected by the leaders for their interest in meteorites and desire to work in Antarctica.
- are in good health and physical condition.
- are often from the curation and research teams.
- have a personality suitable to working and living closely with team members for two months in this isolated, hazardous environment. The members of U.S. teams have included both men and women of many nationalities, with ages ranging from under 30 to over 60.



U.S. Antarctic Meteorite Curation Teams

There are two curation teams, one at NASA's Johnson Space Center and the other at the Smithsonian Institution's National Museum of Natural History. They share the tasks of classification, distribution, and storage. Each team consists of curators, scientists, specialists, and technicians. Duties of team members are often interchangeable. Curatorial staff members may have a variety of educational backgrounds. Members of the curation team may also serve on the collection team.

Team Members — Their Skills, Duties, and Responsibilities

Curators

- write funding proposals.
- interact with administrators, oversight committees, other curators, the field team, research scientists, and the general public.
- classify both Antarctic meteorites and other meteorites sent by individuals.
- direct the work of the laboratory scientists, computer specialists, and technicians.
- publish classifications in newsletters and bulletins.
- some also conduct research projects.
- some work on public displays and education.

Computer Specialist

- manages the database of meteorite classifications and weight inventories.
- prepares data for publication in newsletters and reports to administrators and committees.

Laboratory Scientists

- do the actual handling of meteorites.
- describe new meteorites in laboratory notes.
- take subsamples to distribute to researchers.

Technicians

- prepare meteorite thin sections for microscopic examination and analysis.
- maintain the laboratory equipment, and clean special tools and containers.



Lesson 18 — Student Background

Meteorite Research Team

The research group usually consists of university or college professors, research staff, post doctoral associates, graduate, and undergraduate students. All members of the team need to be skilled in the use of computers. Members of the research team participate on the collection team.

Team Members — Their Skills, Duties, and Responsibilities

Lead Researcher

- is usually a professor who teaches classes or may be a research staff member of an institute.
- writes research proposals to secure funding.
- directs the research.
- writes some of the papers reporting the results.
- makes oral presentations to colleagues at scientific meetings.

Research Associate/Assistant

- is a research staff member, a post doctoral associate, or sometimes a graduate student.
- conducts much of the actual research, including requesting meteorites from the curation team.
- interprets and reports the results.
- writes papers.
- makes oral presentations to colleagues at scientific meetings.

Technician

- may be a regular employee or a student employee in training to be a technician or scientist.
- maintains and operates the laboratory equipment.
- does many of the experiments or analyses.
- contributes to written articles.



Member Profiles for Prospective Antarctic Meteorite Teams

<u>Member</u>	<u>Education / Experience</u>	<u>Interests / Skills</u>
# 1 Geology Female	Univ. of Hawaii Masters Degree	Backpacking Cross-country skiing
# 2 Communications Female	U.S. Army Bachelors Degree + 8 years	Computer programming Reading
# 3 Creative Writing Male	Alvin Community College Associates Degree + 15 years	First aid Photography
# 4 Chemistry Male	Texas A&M - Ph.D. Student Masters Degree + 2 years	Piano Gourmet cooking
# 5 Agriculture Male	Texas Tech Bachelors Degree + 10 years	Bird watching Ham radio
# 6 Pilot Male	U.S. Navy Bachelors Degree + 5 years	Horses Stamp collecting
# 7 Physics/Geochemistry Female	Oregon State Univ. Ph. D. + 5 years	Sail boarding Classical music
# 8 Physical Sciences Female	Univ. of Texas at Dallas Bachelors Degree + 40 years	Baking bread Computers
# 9 Accounting Male	Univ. of California Bachelors Degree + 15 years	Surfing Restoring cars
# 10 Math Female	Univ. of Texas - Ph.D. Student Masters Degree + 5 Years	Geology Conservation
# 11 Astronomy/ Planetary Science Male	Univ. of Arizona Ph. D. + 15 years	Tennis Car repair
# 12 English Male	Univ. of Houston Masters Degree + 5 Years	Desktop publishing Bicycling
# 13 Mechanical Engineer Female	Southern Methodist Univ. Masters Degree + 1 year	Golf Chess
# 14 Business Male	Austin College Bachelors Degree + 2 years	Sailing Microscopes

# 15	Physical Education/ Geochemistry	TCU - Ph.D. Student Masters Degree + 10 years	Stock market analysis Weaving
# 16	Forestry	Univ. of Alaska Ph.D. + 1 year	Woodcarving Cooking
# 17	Music	Rice Univ. Masters Degree + 5 years	Electronics Texas history
# 18	Chemical Engineer	Baylor Univ. Masters Degree + 2 years	Archery Videotaping
# 19	Electrician	San Antonio Comm. Coll. Associates Degree +15 years	Soccer Radio controlled airplanes
# 20	Theater	Trinity Univ. Bachelors Degree + 5 years	Short story writing Rock climbing
# 21	Dentist	Louisiana State Univ. DDS + 5 years	Model building Crossword puzzles
# 22	Psychology	Univ. of Florida Masters Degree + 15 years	Jet skiing Horses
# 23	Marine Biology	Univ. of Delaware Masters Degree + 5 years	Opera House building
# 24	Photography	U.S. Air Force Masters Degree + 2 years	Kayaking Bowling
# 25	Electrical Engineer	Univ. of Oklahoma Bachelors Degree + 30 years	Running Square dancing
# 26	Electron microscopy	Arizona State Univ. Ph.D. + 15	Meteorites Body building
# 27	Political Science	Georgetown Univ. Bachelors Degree + 25 years	Marine mammals Canoeing
# 28	Scientific Illustrator	Univ. of Michigan Masters Degree + 25 years	Gardening Karate
# 29	Computer Science	Miss. State Univ. - Masters Student Bachelors Degree + 10 years	Baseball Sewing
# 30	Librarian	Univ. of Missouri Masters Degree + 5 years	Exploring caves Cooking ethnic food

Exploring Meteorite Mysteries

Lesson 19 — The Daily Shooting Star

“What
can we
believe?”

Objectives

Students will:

- read prepared tabloid articles about meteorites.
- determine whether news articles are fact or fiction.

Background

Truth is often stranger than fiction and sometimes it is difficult to distinguish between the two. Newsstands are filled with tabloids thriving on our fascination with the outlandish. Articles pertaining to space and associated subjects are common and sometimes sound plausible. Since many of the things scientists have learned from meteorites are hard to believe, they lend themselves perfectly to this type of media.

Procedure

Advanced Preparation

1. Copy articles from *The Daily Shooting Star* or prepare transparencies.

Classroom Procedure

1. Instruct students to read articles and determine which are fact or fiction. Each may privately record decisions and keep for future reference if this is being used as a preassessment.
2. If desired, take a true/false class vote and keep results for later review.

Note: Just as the scientific study of meteorites leads us to question the early origins of the universe, these articles were designed to engender uncertainty. Competition is not the focus of this exercise.

3. Ask students to justify their decisions on a voluntary basis and allow non-judgmental discussion — students just might have to eat their words otherwise!
4. Upon completion of the unit, repeat steps 1 and 2. Compare the two sets of responses. Requiring justification for answers that changed would be a good assessment tool.

About This Lesson

The Daily Shooting Star uses a tabloid format to generate interest in meteorites. The articles may be used as an introduction or preassessment before any lessons are started, or it may be a final assessment after the units are completed.

Materials

- The Daily Shooting Star* (pgs. 19.3-19.8)
- writing materials
- blackboard and chalk
- overhead projector and markers

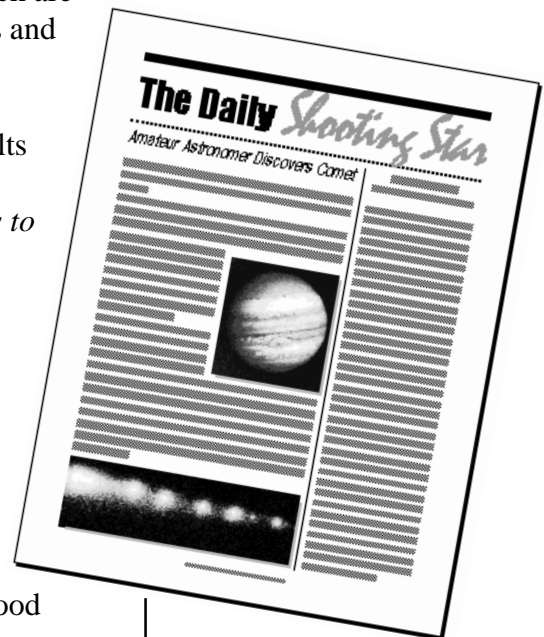

Questions

1. Is there one or more specific thing(s) in the article which influenced your decision about its truth or falsehood?
2. Describe articles you have read in the past which remind you of those you just read. What topic was addressed, did you believe the material presented, why or why not?
3. What difficulties might an author of articles about space encounter?
4. Identify concepts in any of the articles which might be considered to be beyond today's technology but within reason in the future.

Extensions

1. Allow students to write their own sensational scientific articles, based upon truth or fiction. Local newspapers often run material related to scientific topics which may be used for the "truth" articles and "the sky is the limit" when composing the fiction. "Yellow journalistic" tabloid articles provide useful models; however, care should be taken. Some of these articles tend to be risqué.
2. Allow students to prepare and present a dramatic presentation of either true or false articles. A showcase might be presented for younger students where the audience votes on whether they believe the dramas to represent truth or fiction. This could be followed by a "confession session" in which actors emphasize the amazingly true vignettes and tell what was wrong with the fictional ones.
3. If it is available, play a tape of the original "War of the Worlds" radio broadcast for the class. If it is unavailable read a shortened version to them. Follow up with information about the panic audiences experienced when this broadcast aired in the late 1930's. Instruct students to compare the response of that first audience to the response they would expect of a modern day audience.
4. Have groups create and perform commercials for products using meteorites, micro-meteorites, etc., claiming an end to baldness, super-human powers, etc. Packaging and promotional considerations may be included.

Tabloid Answer Key

1. True Amateur Astronomer Discovers Comet
2. True Annihilation Narrowly Avoided
3. False Intelligence Enhancing Meteorites No studies have been done, nor has the need for any been confirmed.
4. False Extraterrestrials Hurl Rock at Earth No evidence has been found of extraterrestrial life; however, 65 million years ago an impact did cause massive destruction.
5. False Longevity Secret Revealed No studies have been done.
6. True Giant Impact Thought to Cause Mass Extinctions
7. False Huge Diamond Discovered in Meteorite Although diamond chips have been found in meteorites, none of significant weight has ever been discovered.
8. True History of Solar System Revealed
9. True Oldest Meteorite Found
10. False Phenomenal New Energy Resource Discovered No technology exists for the harnessing of either lightning or streaking meteors.
11. True Microbes from Mars

The Daily *Shooting Star*

Amateur Astronomer Discovers Comet

A discovery by an amateur astronomer has focused the world's attention on the most exciting astronomical event in history.

David Levy, using an 18-inch telescope on Mount Palomar, California, discovered a comet which later collided with Jupiter. Surprisingly, seventy percent of all initial comet sightings are made by amateurs. Professional astronomers Carolyn and the late Eugene Shoemaker co-discovered the comet which was designated as Comet Shoemaker-Levy 9.

As the comet approached Jupiter, it was torn apart to resemble a "string of pearls" with at least 17 chunks the size of mountains and thousands of smaller fragments. Scientists are now studying data on these collisions gathered by telescopes and spacecraft located in different parts of the solar system. The orbiting Hubble Space Telescope was aimed at Jupiter during the impact. The results of the impact with Jupiter have far reaching implications for the planet Earth. Could we survive an impact of this magnitude? ★

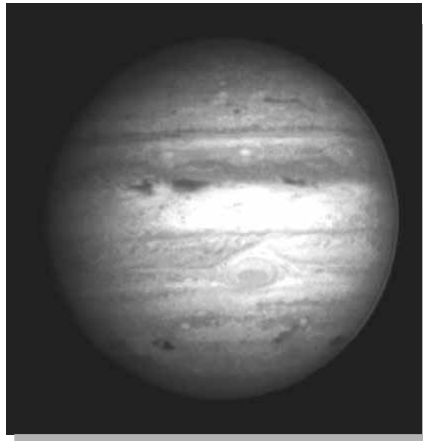

ANNIHILATION NARROWLY AVOIDED

Scientists recently detected an asteroid, named 1993 KA2, which passed within 145,000 kilometers of Earth. It was spotted by David Rabinowitz, an astronomer in Arizona, several hours after it passed Earth. The asteroid was not detected earlier because of its low visual magnitude. Its estimated mass is about five and onehalf tons—about the same as an oil tanker. The asteroid's speed was calculated at 77,000 km/hr., relative to Earth. Most objects aimed at Earth burn up in the atmosphere, but scientists speculate that 1993 KA2 could have created a significant crater had it entered our atmosphere, survived, and impacted. The affects of the collision would have been felt worldwide! In his paper entitled "Collision of astronomically observable bodies with the Earth," G. W. Wetherill concludes, ". . . that impacts of half a km-diameter Earth-crossing objects, energetic enough to produce a 10 km-diameter crater, occur with a frequency of about once every hundred thousand years!" ★

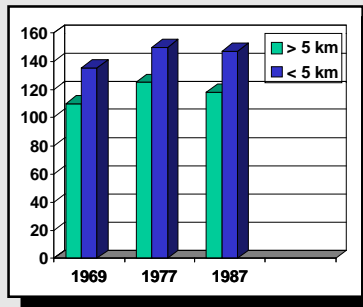

INTELLIGENCE ENHANCING METEORITES

A fifteen year study conducted by an international team of psychologists has determined that fetal exposure to newly fallen meteorites increases I.Q. scores. Scientists became interested in effects from meteorites after Mexican educators, working with 7 child prodigies, discovered that all were born shortly after the Allende meteorite fell there in 1969. A world-wide study was set up encompassing areas within 5 kilometers of meteorite falls occurring between 1977 and 1987. The results strongly indicate that intelligence is affected in developing fetuses by one or more of the atmospheric changes which occur as a result of meteorite impacts. I.Q. scores 20 points above average appear to be common in children whose mothers were exposed to meteorite impact areas during the second trimester of pregnancy. Additional studies are planned. ★

Extraterrestrials Hurl Rock at Earth!

Scientists say they have proof that sixty-five million years ago extraterrestrials hurled a massive rock at the Earth and almost destroyed it! The

the growth of all oceanic organisms.” When asked about the extraterrestrials, Dr. Brashier responded, “I know it sounds far fetched, but Dr. Io has convinced me.”



Dr. Io, a theoretical physicist, could not be reached for comment but his assistant told us about

heat and pressure created by the meteorite landing in the ocean injected a vast amount of water vapor into the atmosphere and caused a tsunami over a kilometer high.

“The fossil record proves the tsunami covered the continent with water,” says Dr. Charlene Brashier. “The tsunami instantly killed several species of land plants and animals, but created a vast ocean full of life. The warm water caused by the meteorite impact accelerated

his theory. “The only force strong enough to hurl an asteroid of that magnitude had to be extraterrestrial. The Hubble telescope sent us some very interesting pictures of the planet Venus. On the surface of the planet are many fossils. The fossil remains clearly show the signs of a planet at war.” ★

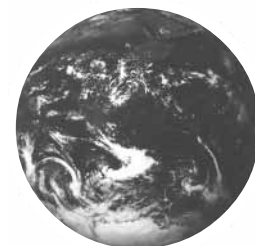

LONGEVITY SECRET

Revealed

A geographical study conducted by graduate students has linked micrometeorites to longevity. Researcher Doug Jackson, while reviewing data compiled by his longevity study team, noted a significant similarity to a study his wife, Karen, is working on. She is a geology student specializing in micrometeorites.

It was really quite by

accident,” Jackson said. “We were sitting around talking about our work and it suddenly hit me



that Karen’s data tables were almost identical to mine.”

Further investigation revealed a significant

relationship between long life and heavy micrometeorite concentrations. “These people have probably been ingesting micrometeorites for years,” Jackson added. Initial studies indicate that a unique nutrient, found in the tissues of centenarians, is a component of most micrometeorites which appears to be the key to long life. Systemic Supplies, Inc. has proposed a patent for vitamins containing the newly discovered nutrient. ★

Giant Impact

Thought to Cause Mass Extinctions

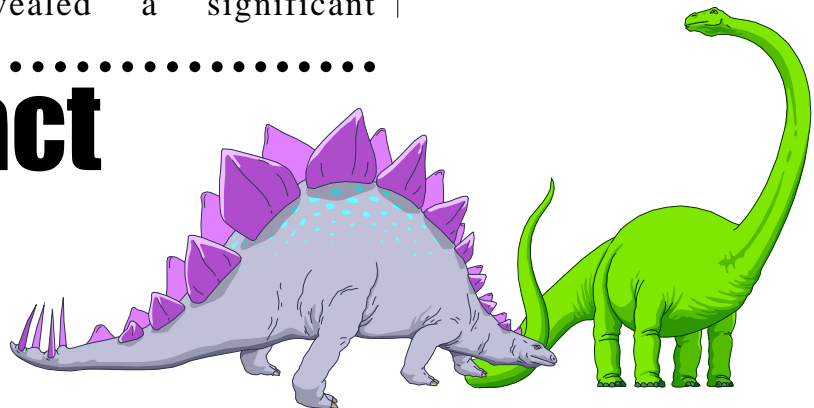

Meteorologists and geologists around the world have confirmed the occurrence of a major catastrophe in Earth’s history which led to the deaths of numerous life forms including the giant sea nautilus.

Scarring of the ocean floor and land on the Yucatan Peninsula identify that area as the site of a huge



have confirmed the occurrence of a major catastrophe in Earth’s

meteorite fall. Fossils found in the area show that massive extinctions occurred as a result of the impact. Not only land inhabitants but also oceanic species were endangered when the lower organisms on the food chain began to disappear. Among those unique creatures lost forever was the giant sea nautilus, a valuable link to understanding adaptations of species.

Scientists regularly undertake worldwide stud-

ies of corings of glacial ice, geological strata, and mature trees to trace climate changes. The percentage of carbon dioxide found in Antarctic ice from that ancient time changed dramatically following the impact of the huge meteorite on Earth. Based on current knowledge of the “greenhouse” effect, scientists recognized the indications of the ancient change in climate. Along

Extinction continued on page 19.6

Huge Diamond Discovered in Meteorite

Meteorite researchers at a prestigious scientific institute in Houston, Texas have discovered a massive 6.74 carat diamond in an Antarctic meteorite. Scientists have been collecting meteorites in Antarctica for several years. After collection the samples are packaged and shipped to Houston for scientific analysis. A number of diamond chips have been recovered from meteorites, but the largest total weight to date had been less than .07 carats.

Dr. Lynn Allen, investigative team leader, expressed mixed feelings over the find. "Funding for the Antarctic project will not be such a problem now," she told this reporter. "This stone is obviously very valuable and will enhance the viability of our research. Scientific knowledge is important to many people, but when a dollar figure can be assessed, financiers are more willing to support our work. The sad part is that people who might have willingly relinquished meteorites to the scientific community may be more reluctant to do so now."

Officials have made no decisions as to the disposition of the diamond. ★

History of the Solar System **REVEALED**

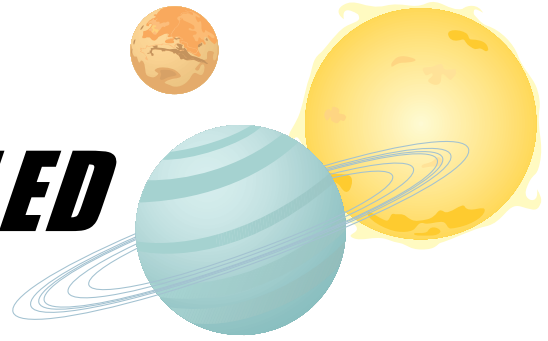
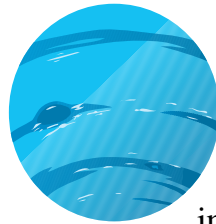

Scientists at the Lunar and Planetary Institute have released startling information which supports the theory that the solar system arose from gaseous and particulate matter. This information was obtained through intensive study of meteorites from the Moon, Mars, and the asteroid belts. Dr. Allan H. Treiman states, "Meteorites are the best clues to how the solar system formed. In our labs, we can take meteorites apart and learn just how they were put together, whether it was on the Moon, on Mars, or in a dusty gas cloud orbiting a very young Sun."

Previous studies of rocks have helped scientists understand the Earth's formation. Materials and structure found in Earth rocks and meteorites are very similar. Those similarities led researchers to the conclusion that, as they are learning about how meteorites were formed, they were also learning how other planetary bodies were formed. Just as planets have layers (core, mantle, crust), meteorites discovered on the Earth's surface reveal samples of the same types of layers from other celestial bodies. Though small in size, meteorites provide windows to explore the processes that formed the solar system.

As more meteorites are discovered and studied, scientists feel confident that more information about the origins of the solar system and perhaps life itself will be understood. ★

Extinction continued from page 19.5

with the change in weather patterns, food chains broke down and massive extinctions resulted.

In response to a reporter's questions about what would happen if a similar impact were to happen in modern times, geologist Dr. Virgil L. "Buck" Sharpton quipped, "It would be a real bad day. But it would solve the problems of nuclear proliferation and global warming!" ★

OLDEST METEORITE FOUND



A meteorite which fell in Japan in 861 has been identified as the oldest witnessed fall of which pieces are preserved.

Masako Shima and associates recently presented information to the Meteoritical Society about the Nogata-Shi meteorite, a chondrite. The Nogata-Shi meteorite fell at a Shinto shrine on May 19, 861, by the Julian calendar. It has been preserved at the religious site as a treasure of the shrine in a specially marked wooden box .

Many meteorites have been on the Earth's surface for thousands of years. However, only specimens whose sightings have been documented may be considered in the category

of "observed falls." "It appears to us that observation of this meteorite fall has been handed down by word of mouth," states Akihiko Okada of the Institute of Physical and Chemical Research in Japan.

Scientists had previously considered the Ensisheim stone, which fell in Germany in 1492, to be the oldest witnessed fall. The Nogata-Shi predates the Ensisheim stone by over 600 years and renews speculation about the existence of other undiscovered, preserved meteorites. ★

Phenomenal New Energy Resource DISCOVERED

Lewis Berkeley Lab (LBL) has announced the development of a new process which will harness the vast energy available from streaking meteors.

"The technology necessary to construct a functioning plant utilizing this type of power is available now," Dr. Robert Faraday states. "Much

depends upon whether or not utility companies are willing to make this drastic a change in their operations."

Based on techniques used in collecting electricity from lightning flashes, LBL has projected the harnessing of billions of kilowatts of power, during periods of active meteor showers. This could be equivalent to the production of three nuclear power plants. It is estimated that the savings to the consumer would be substantial once the system

has been placed "on line."

No official comments were offered by utility industry representatives, but one was heard to remark after the news conference with LBL, "This is a hare-brained scheme — a waste of public resources." ★

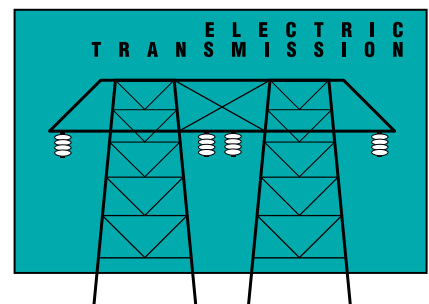

Microbes from Mars !

In August 1996, a panel of scientists revealed a secret held for two years. They unveiled the first evidence of possible life on the Red Planet. The Mars meteorite research team, led by Dave McKay and Everett Gibson, described startling findings in an ancient meteorite which was blasted off Mars and landed in Antarctica. This rock contains organic molecules and microscopic bits of iron oxides like those produced by bacteria. Even more amazing are images of worm-like forms so small that they can only be seen by the most powerful electron microscope. Even though there are other interpretations of each of the pieces of evidence, taken together, “we believe that these tiny guys can be interpreted as (fossil) bacteria,” says McKay.

Reaction of other scientists to the discovery has been skeptical, and in some cases, downright hostile. Some scientists, who have studied the meteorite, say that the carbonate minerals containing these features formed at temperatures too high for life to exist. Ralph Harvey suggests the worm-like forms aren't microfossils, but are elongated iron oxides, formed in volcanic fumaroles too hot to support life. Luann Becker suggests that the organic molecules are produced by contamination in Antarctica.

The debate rages hot and cold. The Life on Mars team continues to collect more data—magnetics and isotope chemistry suggest a cold origin. Meanwhile, the naysayers add more lines of negative



evidence—the fossil-like forms are too small to hold a molecule of DNA. Tim Swindle, who took an informal poll of planetary scientists, says it came out even, with most scientists sitting on the fence waiting for more data. ★

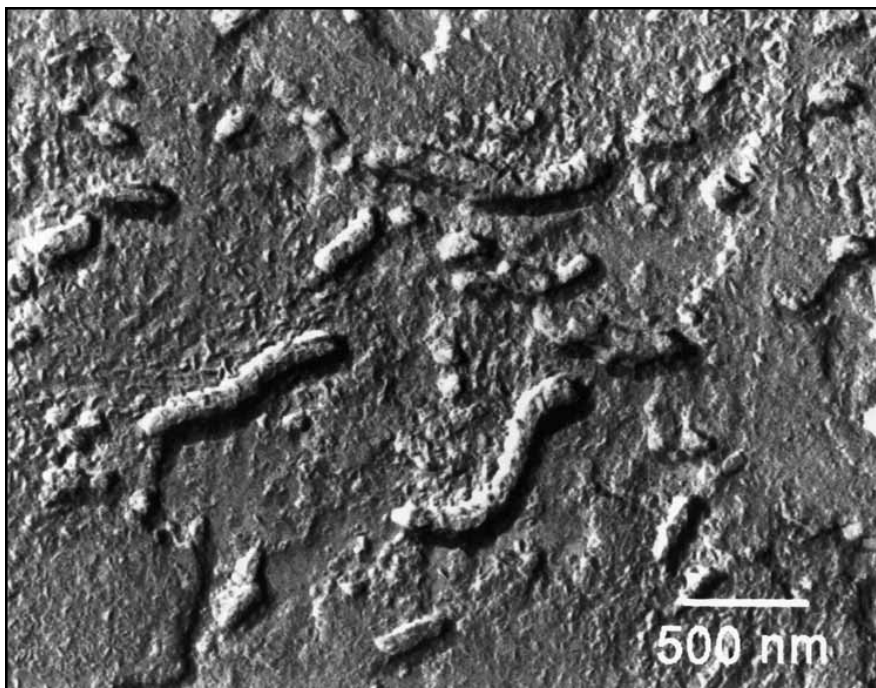

Exploring Meteorite Mysteries

Glossary

Words that appear *in italic type* within a definition also are defined in the Glossary.

Absorbent: able to suck up liquid like a sponge.

Accrete (accretion): accumulate under the influence of *gravity* and some minor forces.

Achondrite: *stony meteorite* without *chondrules*.

Amino Acids: organic acids that are the components of proteins.

Angular: a shape description that indicates an object has one or more angled edges rather than rounded edges.

Anorthosite: an *igneous* rock made up almost entirely of plagioclase feldspar.

Aphelion: the point of a celestial body's *orbit* most distant from the Sun.

Asteroid: one of thousands of small (*diameters* under 1000 km) solid planetary bodies *orbiting* the sun; most *orbit* the Sun between Mars and Jupiter, but a few come closer as they cross the *orbits* of Earth or Mars.

Asteroid belt: area between Mars and Jupiter where thousands of *asteroids orbit* the Sun.

Astronomer: one who studies the science of celestial bodies and their origins, magnitudes, motions, and compositions.

Atmosphere: mixture of gases that surround a planet.

Attrition: the amount of material worn away during sample preparation; small losses.

Bachelor's degree: usually the lowest academic degree given by a college or university.

Basalt: fine-grained, dark-colored *igneous* rock composed primarily of plagioclase feldspar and

pyroxene; other *minerals* such as olivine and opaques are usually present.

Basaltic achondrite: a type of *meteorite* consisting of the *minerals* feldspar and pyroxene; they are similar to *basalts* from lava flows on Earth.

Bleb: a small, usually rounded *inclusion* of one material in another.

Breccia: rock consisting of *angular*, coarse fragments embedded in a fine-grained *matrix*.

Carbonaceous chondrite: a primitive type of *meteorite* usually with *chondrules*; they contain water and *carbon compounds*, including *organic molecules*.

Carbon compounds: forms of carbon combined with other elements, includes *organic molecules* such as *amino acids*.

Catastrophe: a great disaster or misfortune.

Chromatography: separation of complex solutions into chemically distinct layers, usually different colors, by seepage through an *absorbent* material.

Chondrite: *stony meteorite* containing *chondrules* embedded in a fine grained *matrix* of pyroxene, olivine, and metallic nickel-iron.

Chondrule: a small rounded body of various materials, chiefly olivine or pyroxene, found embedded in a usually fragmental *matrix* in certain of the *stony meteorites*.

Classification: the formal system of arranging objects or information into like groups.

Clast: a broken piece of rock formed by the breakup of a larger object.

Clay: a size term denoting particles, regardless of *mineral* composition, with diameters less than 1/256 mm.

Comet: a small body of ice and dust circling the sun in an *elliptical orbit*; when it comes near the Sun gases are released to form a tail that points away from the Sun.

Composition: the amounts of all the elements in a rock or *mineral*.

Condensation: to form a liquid or solid from the gaseous state.

Core: the central region of a planet or moon, frequently made of different materials than the surrounding regions (*mantle* and *crust*); Earth and the Moon are thought to have cores of metallic iron and nickel.

Cosmic spherules: melted droplets of *meteorites*, less than 1mm in size, found in ocean sediments and ice.

Crater : a hole or depression (see *impact*); most are roughly circular or oval in outline; on Earth most natural craters visible at this point in geologic time are of volcanic origin; on the Moon most craters are of *impact* origin.

Cretaceous: the period of geologic time from approximately 140 million years ago to about 65 million years ago; abbreviated symbol is K.

Cross section: a profile portraying an interpretation of a vertical section of the Earth explored by geophysical and/or geological methods.

Crust: the outermost layer of a planet or moon, above the *mantle*.

Crystallization: to form crystals.

Cumulate: collection of *minerals* that have been separated from molten rock by *density* settling.

Curation: taking care of collections of samples and distributing information on those samples.

Curator: one in charge of a collection or exhibit of

items such as in a museum.

Deposition: the process of accumulation of a *sedimentary* layer of rock or precipitate.

Diameter: the length of a line that goes from edge to edge of a circle or other shape and also passes through the center of that shape.

DNA: deoxyribonucleic acid; functions as the transfer of genetic information from cells in living organisms.

Dense: means the mass of an object is relatively high per unit volume of the object; object could be described as “heavy for its size”.

Density: *mass* per unit *volume*; how much material is in a given space.

Differentiation: chemical zonation caused by differences in the *densities* of *minerals*; *dense* materials sink, less *dense* materials float.

Diffacted: when light beams are deflected or bent by interaction with an object (diffraction).

Doctor of Philosophy: usually the highest academic degree given by a university or college in any field of academic study (Ph.D. or doctorate).

Ecliptic plane: the plane defined by the *orbit* of the Earth around the Sun; most planets *orbit* in or near the ecliptic plane.

Ejecta: material thrown out from and deposited around an *impact crater*.

Electromagnetic spectrum: energy ranges from gamma-rays through x-rays, *ultraviolet*, visible light, *infrared*, microwave, all radio waves (all having specific energy).

Ellipse: (elliptical) a closed curve of oval shape.

Emit: to give off, such as light or sound.

Erosion: process of physically changing and or moving rocky material; on Earth this especially includes *weathering* and transport of material by water and wind.

Expedition: a journey for a particular purpose such as research or discovery.

Fall: is a designation for a *meteorite* that was observed as it came through Earth's atmosphere and was retrieved soon afterward.

Find: is a *meteorite* that was not observed to *fall*; it may have been on Earth for a long time.

Fireball: the streak of light and loud noise of a large *meteor* going through the Earth's *atmosphere*.

Friable: easily crumbled rock fragments.

Fusion crust: dark glassy coating on the surface of a *meteorite*, caused by heating as the *meteorite* enters the *atmosphere*.

Geochemist: a scientist who studies the chemical composition of, and chemical changes in the Earth or other planetary bodies.

Geologist: scientist who studies Earth, its materials, the physical and chemical changes that occur on the surface and in the interior, and the history of the planet and its life forms; planetary geologists extend their studies to the Moon, planets, and other solid bodies in the *solar system*.

Geophysics: extensive experimental and modeling studies of the Earth and other planetary bodies with respect to their structure and development.

Gravity: a force of attraction pulling any two things toward each other, dependent on the *mass* of the objects.

Heterogeneous: composed of several different types of material.

Highlands: oldest exposed areas on the surface of the Moon; extensively *cratered*, and chemically distinct from the *Mare*.

Homogeneous: composed of one type of material.

Hypothesis: an idea or group of ideas that attempt to explain an observed or predicted event or occurrence.

Igneous: rocks or processes involving the formation and solidification of hot, molten *magma* on the surface of a planetary body or below the surface.

Impact: the forceful striking of one body, such as a *meteorite*, against another body such as a moon or planet (*crater*).

Impact crater: hole or depression formed by a *meteorite* colliding with a surface.

Impactor: object that strikes (*impact*) a surface, may create a *crater* (*projectile, meteorite*).

Incandescent light: light which came from an electrically heated filament.

Incident light: light that has struck an object (see also reflected light).

Inclusions: a fragment of another rock enclosed in a rock.

Infrared: the portion of the electromagnetic spectrum with wavelengths of from 0.7 to about 1.0 micrometers, just beyond the red end of the visible spectrum.

Inorganic: compounds that are not formed by living organisms.

Interplanetary dust particles: microscopic bits of *asteroids* or *comets*; these particles can be collected from high in the *atmosphere*.

Iridium: a hard, brittle, very heavy, metallic chemical element used in alloys; found in greater percentages in *meteorites* as compared to Earth rocks.

Iron meteorite: *meteorite* consisting of metallic iron and nickel.

Isotope: elements having an identical number of protons in their nuclei but differing in their number of neutrons.

Kinetic energy: the energy of a body or *mass* in motion; with greater speed and *mass* the kinetic energy increases.

Latitude: the angular distance North or South from the Earth's equator measured in degrees; Equator being 0° and the poles 90°N and 90°S.

Lava: fluid *magma* that flows onto the surface of a planet or moon; erupted from a *volcano* or fissure;

the rock formed by solidification of magma.

Layer: a bed of stratum or rock.

Longitude: the angular distance East or West, between the meridian of a particular place on Earth and that of Greenwich, England, expressed in degrees or time.

Lunar meteorites: *meteorites* that have been identified through their chemistry and *minerals* as being from the Moon.

Magma: term applied to molten rock in the interior of a planet or moon; when it reaches the surface, magma is called *lava*.

Magnetism: a property possessed by certain bodies, whereby under certain circumstances, they repel or attract one another according to determined laws.

Magnetic field: a force that acts over a region of space around a magnetically charged body.

Mantle: a mostly solid layer of Earth lying beneath the *crust* and above the *core*; consisting mostly of iron and *silicate minerals*.

Maria: dark areas on the Moon covered by *basalt lava* flows (singular *Mare*).

Martian meteorites: *meteorites* that have been identified as pieces of Mars by a combination of their relatively young age and their chemical similarity to Viking data from Mars.

Mass: the amount of matter in a given object.

Master's Degree: academic degree higher than a *bachelor's degree* but lower than a *doctoral* degree.

Matrix: the smaller sized grains in a rock, where the rock consists of large grains or fragments surrounded by smaller grains.

Metal: any of a class of substances that typically are opaque, are good conductors of electricity, and often have a shiny luster like gold.

Metamorphic (metamorphosed): rocks that have recrystallized in a solid state as a result of changes in temperature, pressure, and chemical environment.

Meteor: relatively small body of matter traveling through interplanetary space.

Meteorite: a metallic or stony (*silicate*) body that has fallen on Earth, Moon or other planetary body from outer space (see *Impactor*, *Projectile*).

Meteor shower: group of *meteors* or comet dust, traveling together, which enter the *atmosphere* within a few hours.

Meteorite shower: a large number of similar *meteorites* falling together; caused by the breakup of a large *meteorite* in the atmosphere.

Meteoriticist: someone who studies *meteorites*.

Micrometeorites: *meteorites* smaller than 1 mm.

Mineral: naturally occurring *inorganic* solid with a definite chemical composition and crystal structure.

Mineralogy: the mix of *minerals* which make up a rock.

Orbit: the path of an object in space moving about another under gravitational attraction.

Ordinary chondrites: the most common class of *meteorites*, consisting of variable amounts of metal and chondrules in a matrix of mostly *silicate minerals*.

Organic molecules: compounds of carbon, hydrogen and oxygen, that form complex molecules (may or may not be from living organisms).

Perihelion: the point of a celestial body's *orbit* closest to the Sun.

Planetary geology: the study of the planets in our *solar system* concerning the history and formation of the interior and surface.

Planetary meteorites: a class of *igneous* or *brecciated meteorites* from other planets; currently, *meteorites* have been found that come from the Moon and Mars.

Platy: the *texture* of a rock that is composed of flat *minerals* or rock fragments.

Porous: contains open or void spaces between solid

material.

Post doc: researcher who has completed a *Doctor of Philosophy* degree and has a temporary position such as a fellowship to pursue a specific type of research.

Projectile: object that *impacts* a surface.

Quartz: a common, often transparent crystalline *mineral* that is a form of a silica.

Research: studious and critical inquiry aimed at the discovery and interpretation of new knowledge.

Reflectance: the amount of light of a particular color reflected by a surface, divided by the amount of light of the same color that strikes the surface.

Reflectance spectroscopy: the study of the colors of light reflected from a surface.

Reflected light: light which strikes a surface and bounces back, as happens with a mirror.

Regmaglypt: any of various small indentations or pits on the surface of *meteorites*.

Regolith: loose, *unconsolidated* rock, *mineral*, and glass fragments; on the Moon and some other planetary bodies, this debris is produced by *impacts* and blankets the surface.

Retrograde: an *orbit* that moves in the opposite direction of Earth's *orbit*.

Rim: the border of a land form, such as the curved edge surrounding the top part of a *crater*.

Scale model: an object that gives the size of the sample in proportion to the size of the actual thing.

Sediment: solid rock or *mineral* fragments transported and deposited by wind, water, gravity, or ice; precipitated by chemical reactions; or secreted by organisms; accumulated as layers in loose, *unconsolidated* form.

Sedimentary: *rock* formed when *sediment* is compacted and solidified.

Shock: a sharp *impact* or violent shake; evidence of large shocks may be seen in the rocks and *minerals*

near an *impact crater*.

Silicate: *minerals* that contain the elements Si and O, plus one or more metals: Mg, Fe, Ca, Na, Al.

Solar nebula: gravitational accumulation of solid particles and dust around the Sun.

Solar power: energy derived from the Sun or sunlight for use as a source of *electricity*.

Solar system: the Sun and all the objects such as the planets, moons, *asteroids*, and *comets* that *orbit* the Sun.

Solar wind: the stream of charged particles, mainly ionized hydrogen, moving outward from the Sun with velocities in the range of 300-500 kilometers per second.

Soot: a black substance that is formed when something burns.

Specimen: a sample, as a rock, fossil, or ore.

Spectroscopy: the excitation of the spectrum, its visual or photographic observation, and the precise determination of wavelengths.

Sphere: an object that is round or almost round in all dimensions like a ball.

Static electricity: stationary charges of electricity.

Stony-iron: a class of *meteorites* composed mostly of an intimate mixture of *silicates* and iron metal.

Stony meteorite: a class of *meteorites* composed mostly of silicate *minerals*.

Strewn field: a generally *elliptical* pattern of distribution of recovered *meteorites*, formed when a *meteor* is fragmented as it passes through the *atmosphere*.

Superstition: beliefs or practices resulting in fear of the unknown, ignorance and trust in magic or chance.

Technician: a person who has acquired the technique of a specialized skill or subject.

Tektites: small fragments of melted and aerodynamically shaped rock that were ejected from a large *impact crater*.

Tectonic: pertaining to rock forms due to deformation in the *crust* of Earth and other planetary bodies.

Terrain: area of the surface with a distinctive physical or geological character.

Tertiary: the period of geologic time between 65 and 2 million years ago, abbreviation is T.

Texture: general physical appearance of a rock.

Triangulation: method of finding the distance to an object or location of an event in the sky by creating a triangle, with two vertices the ground, and the object at the third vertex.

Ultraviolet: having a wavelength shorter than visible light and longer than x-rays.

Unconsolidated: materials loosely pack but not cemented to each other.

Unfractured: does not contain breaks or cracks.

Uniform: having always the same form, manner, or degree.

Vaporize: to change something from a liquid or a solid

to a gaseous state as in rock that is completely altered to gas during large *impacts*.

Velocity: rate of motion in a specific direction.

Vesicle: bubble-shaped cavity in a volcanic rock formed by expanding gases.

Volatiles: chemical elements that enter a gas phase at relatively low temperatures.

Volcanism: the physical processes of a *volcano*.

Volcano: mountain formed from the eruption of *igneous* matter through a vent; volcanism refers to all natural processes resulting in volcanoes and other *igneous* surface events.

Voltage: electromotive force measured in volts.

Volume: space occupied, as measured by cubic units.

Weathering: the mechanical breakdown and chemical alteration of rocks and *minerals*.

Wick: (verb) to draw a liquid on to or up a solid (i.e. a towel).

Zoologist: scientist who studies animals.

Exploring Meteorite Mysteries Education Resources

Meteorite Resources

Teacher's Guide:

The following companion volume is available from NASA Educator Resource Centers or NASA Central Operation of Resources for Educators: *Exploring the Moon*, G. Jeffrey Taylor et al, 1994, NASA EP-306.

Video:

Meteorites-Vol. 1: Menace from the Sky. Vol. 2: Witnesses from Beyond the Times, Austrian Broadcasting Corporation, 1993, 84 minutes. Atlas Video, Inc. Bethesda, Maryland.

Slides:

Accompanying *Exploring Meteorite Mysteries* slide set is available from NASA CORE. *Terrestrial Impact Craters*, set of 26 slides with guide and *A Spacecraft Tour of the Solar System*, 40 slides with guide.

Lunar Planetary Institute
3600 Bay Area Boulevard
Houston, Texas 77058-2186
281-486-2172 or FAX 281-486-2186

Posters:

Meteorites Poster (#328)
The Planetary Society
Sales Department
65 North Catalina Avenue
Pasadena, California 91106-2301

Comet Chart (#31-0) and *Cosmic Catastrophies* (#46-9)

Hansen Planetarium Publications
1845 South 300 West, #A
Salt Lake City, Utah 84115-1804
1-800-321-2369

Web Sites:

<http://www-curator.jsc.nasa.gov/curator/curator.htm>
<http://www-curator.jsc.nasa.gov/curator/antmet/antmet.htm>
<http://www-sn.jsc.nasa.gov>
<http://www.jsc.nasa.gov/pao/educators/>
<http://www.ewu.edu/CNRU/Dept/Antsci/geol/ANSMET/ANSMET.htm>
<http://hurlbut.jhuapl.edu/NEAR/>
<http://pdcsva.jpl.nasa.gov/stardust/home.html>
<http://nssdc.gsfc.gov/planetary/planets/asteroidpage.html>

Bibliography

Children's Books:

Asteroids, Comets and Meteors, Gregory L. Vogt, 1996, Millbrook Press, 32 p.
Comets and Meteors, Isaac Asimov, 1990, Dell Publishing, 32 p.
Magical, Mysterious Meteorites, Madelyn Wood Carlisle, 1992, Barron's Educational Series Inc., 32p.

Introductory Book:

Meteorites: The Key to Our Existence, Robert Hutchison and Andrew Graham, 1992, Natural History Museum Pub. 60p.

In Depth Books:

Rocks from Space, O. Richard Norton, 1994, Mountain Press, 449p.
Thunderstones and Shooting Stars: The Meaning of Meteorites, Robert T. Dodd, 1986, Harvard University Press, 196p.
Meteorites and Their Parent Planets, Harry Y. McSween, Jr., 1987, Cambridge University Press, 236p.

NASA Resources for Educators

NASA's Central Operation of Resources for Educators (CORE) was established for the national and international distribution of NASA-produced educational materials in audiovisual format. Educators can obtain a catalogue and an order form by one of the following methods:

- **NASA CORE**
Lorain County Joint Vocational School
15181 Route 58 South
Oberlin, OH 44074
- Phone (440) 774-1051, Ext. 249 or 293
- Fax (440) 774-2144
- E-mail nasaco@leeca8.leeca.ohio.gov
- Home Page: <http://spacelink.nasa.gov/CORE>

Educator Resource Center Network

To make additional information available to the education community, the NASA Education Division has created the NASA Educator Resource Center (ERC) network. ERCs contain a wealth of information for educators: publications, reference books, slide sets, audio cassettes, videotapes, telelecture programs, computer programs, lesson plans, and teacher guides with activities. Educators may preview, copy, or receive NASA materials at these sites. Because each NASA Field Center has its own areas of expertise, no two ERCs are exactly alike. Phone calls are welcome if you are unable to visit the ERC that serves your geographic area. A list of the centers and the regions they serve includes:

AK, AZ, CA, HI, ID, MT, NV, OR, UT, WA, WY
NASA Educator Resource Center
Mail Stop 253-2
NASA Ames Research Center
Moffett Field, CA 94035-1000
Phone: (415) 604-3574

AL, AR, M, LA, MO, TN
U.S. Space and Rocket Center
NASA Educator Resource Center
NASA Marshall Space Flight Center
P.O. Box 070015 Huntsville, AL 35807-7015
Phone: (205) 544-5812

CT, DE, DC, ME, MD, MA, NH, NJ, NY, PA, RI, VT
NASA Educator Resource Laboratory
Mail Code 130.3
NASA Goddard Space Flight Center
Greenbelt, MD 20771-0001
Phone: (301) 286-8570

CO, KS, NE, NM, ND, OK, SD, TX
JSC Educator Resource Center
Space Center Houston
NASA Johnson Space Center
1601 NASA Road One
Houston, TX 77058-3696
Phone: (281) 483-8696

FL, GA, PR, VI
NASA Educator Resource Laboratory
Mail Code ERL
NASA Kennedy Space Center
Kennedy Space Center, FL 32899-0001
Phone: (407) 867-4090

MS
NASA Educator Resource Center
Building 1200
NASA John C. Stennis Space Center
Stennis Space Center, MS 39529-8000
Phone: (601) 688-3338

NASA Educator Resource Center
JPL Educational Outreach
Mail Stop CS-530
NASA Jet Propulsion Laboratory
4800 Oak Grove Drive
Pasadena, CA 91109-8099
Phone: (818) 354-6916

CA cities near the center
NASA Educator Resource Center for
NASA Dryden Flight Research Center
45108 N. 3rd. Street East
Lancaster, CA 93535
Phone: (805) 948-7347

KY, NC, SC, VA, WV
Virginia Air and Space Museum
NASA Educator Resource Center for
NASA Langley Research Center
600 Settlers Landing Road
Hampton, VA 23669-4033
Phone: (757) 727-0900 x 757

VA and MD's Eastern Shores
NASA Educator Resource Lab Education
Complex - Visitor Center Building J-1
NASA Wallops Flight Facility
Wallops Island, VA 23337-5099
Phone: (757) 824-2297/2298

IL, IN, MI, MN, OH, WI
NASA Educator Resource Center
Mail Stop 8-1
NASA Lewis Research Center
21000 Brookpark Road
Cleveland, OH 44135-3191
Phone: (216) 433-2017

Regional Educator Resource Centers (RERCs) offer more educators access to NASA educational materials. NASA has formed partnerships with universities, museums, and other educational institutions to serve as RERCs in many states. A complete list of RERCs is available through CORE, or electronically via NASA Spacelink.

NASA On-line Resources for Educators provide current educational information and instructional resource materials to teachers, faculty, and students. A wide range of information is available, including science, mathematics, engineering, and technology education lesson plans, historical information related to the aeronautics and space program, current status reports on NASA projects, news releases, information on NASA educational programs, useful software and graphics files. Educators and students can also use NASA resources as learning tools to explore the Internet, accessing information about educational grants, interacting with other schools which are already on-line, and participating in on-line interactive projects, communicating with NASA scientists, engineers, and other team members to experience the excitement of real NASA projects.

Access these resources through the NASA Education Home Page:
<http://www.hq.nasa.gov/education>
or, for more information send an e-mail to:
comments@spacelink.msfc.nasa.gov

NASA Television (NTV) is the Agency's distribution system for live and taped programs. It offers the public a front-row seat for launches and missions, as well as informational and educational programming, historical documentaries, and updates on the latest developments in aeronautics and space science. NTV is transmitted on the GE-2 satellite, Transponder 9C at 85 degrees West longitude, vertical polarization, with a frequency of 3880 megahertz, and audio of 6.8 megahertz.

Apart from live mission coverage, regular NASA Television programming includes a News Video File from noon to 1:00 pm, a NASA History File from 1:00 to 2:00 pm, and an Education File from 2:00 to 3:00 pm (all times Eastern). This sequence is repeated at 3:00 pm, 6:00 pm, and 9:00 pm, Monday through Friday. The NTV Education File features programming for teachers and students on science, mathematics, and technology. NASA Television programming may be videotaped for later use.

For more information on NASA Television, contact:
NASA Headquarters, Code P-2, NASA TV, Washington, DC 20546-0001 Phone: (202) 358-3572
Home Page: <http://www.hq.nasa.gov/office/pao/ntv.html>

How to Access NASA's Education Materials and Services, EP-1996-11-345-HQ This brochure serves as a guide to accessing a variety of NASA materials and services for educators. Copies are available through the ERC network, or electronically via NASA Spacelink. NASA Spacelink can be accessed at the following address: <http://spacelink.nasa.gov>.



Litho I



1cm

Litho II

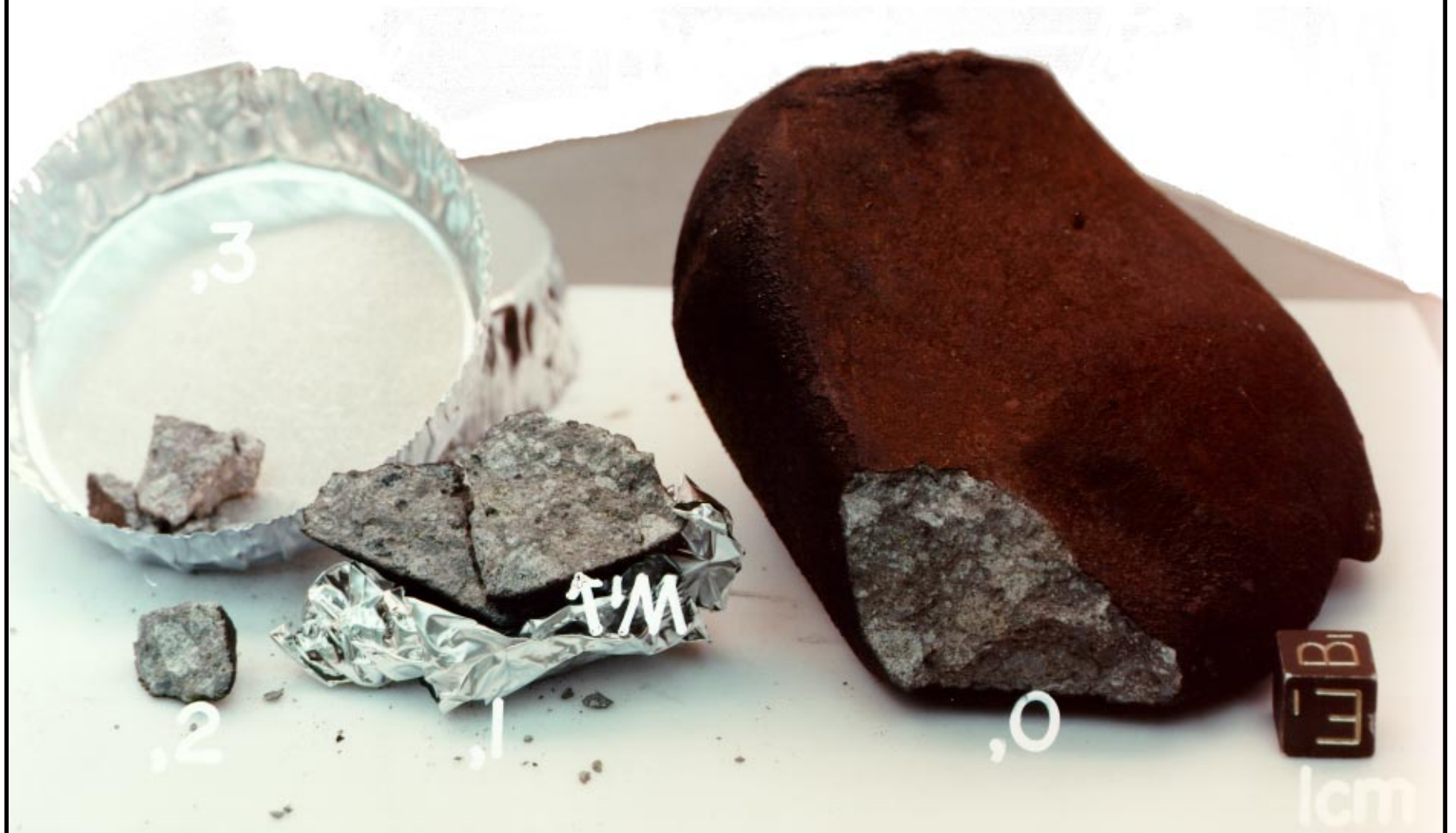

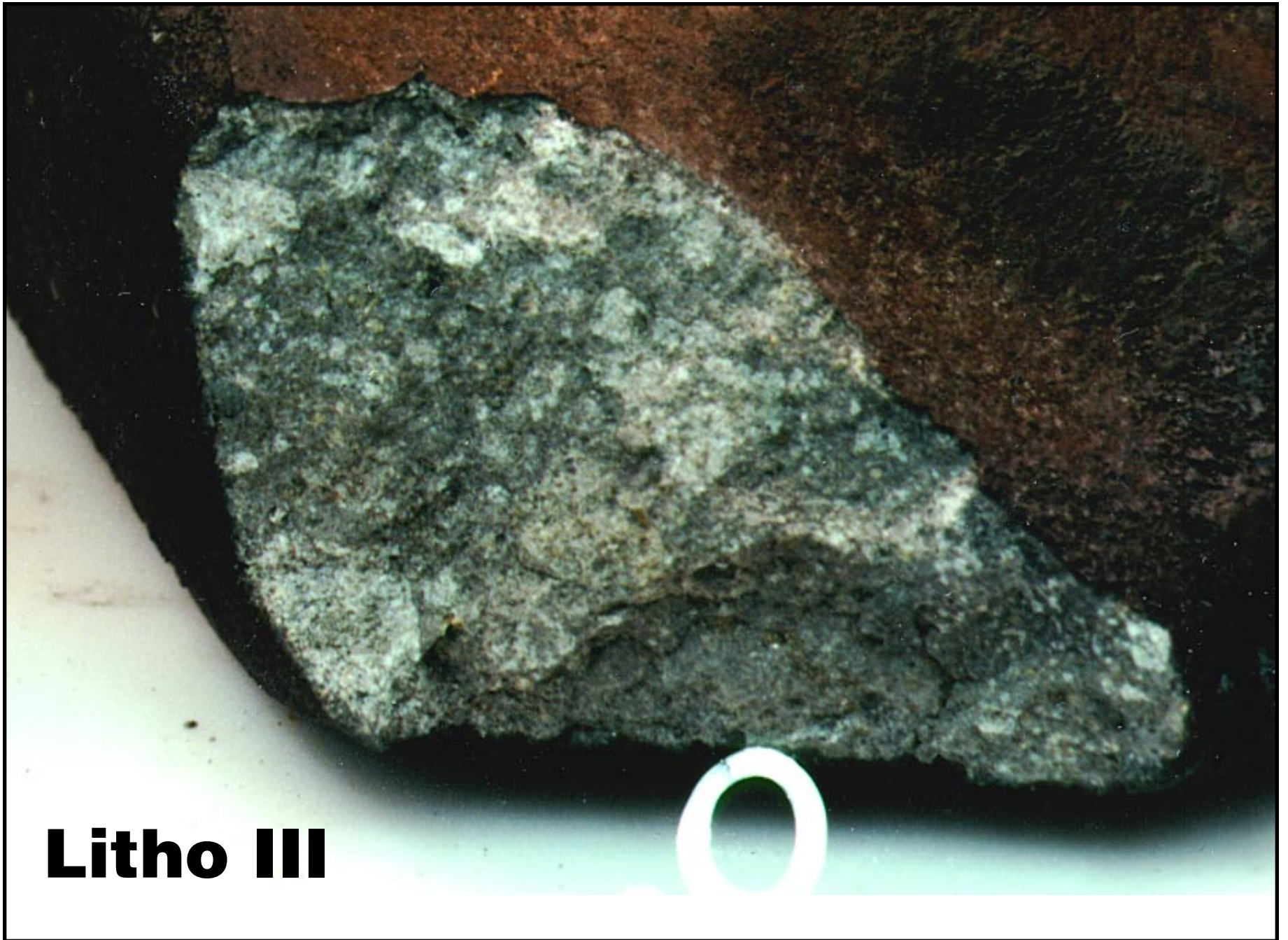

Litho III

Litho IV

